



Warning



- Ask a qualified installer or contractor to install this product. Do not try to install the product yourself. Improper installation can result in water or refrigerant leakage, electrical shock, fire or explosion.
 - Use only those parts and accessories supplied or specified by Daikin. Ask a qualified installer or contractor to install those parts and accessories. Use of unauthorised parts and accessories or improper installation of parts and accessories can result in water or refrigerant leakage, electrical shock, fire or explosion.
 - Read the user's manual carefully before using this product. The user's manual provides important safety instructions and warnings. Be sure to follow these instructions and warnings.
- If you have any enquiries, please contact your local importer, distributor and/or retailer.

Cautions on product corrosion

1. Air conditioners should not be installed in areas where corrosive gases, such as acid gas or alkaline gas, are produced.
2. If the outdoor unit is to be installed close to the sea shore, direct exposure to the sea breeze should be avoided. If you need to install the outdoor unit close to the sea shore, contact your local distributor.



EDUS371435-N

R-410A

Engineering Data Installation

VRV IV

REYQ-TTJU, 208/230V, 60Hz
REYQ-TYDN, 460V, 60Hz

VRV III

REYQ-PCTJ, 208/230V, 60Hz
REYQ-PCYD, 460V, 60Hz



Appendix 1 Installation Manual REYQ-T

1. Installation Manual i

1. Installation Manual

REYQ72-168TYDN
REYQ72-168TTJU

Safety considerations

Read these Safety considerations for Installation carefully before installing an air conditioner or heat pump. After completing the installation, make sure that the unit operates properly during the startup operation.

Instruct the customer on how to operate and maintain the unit.

Inform customers that they should store this Installation Manual with the Operation Manual for future reference.

Always use a licensed installer or contractor to install this product.

Improper installation can result in water or refrigerant leakage, electrical shock, fire, or explosion.

Meanings of **DANGER**, **WARNING**, **CAUTION**, and **NOTE** Symbols:

 **DANGER** Indicates an imminently hazardous situation which, if not avoided, will result in death or serious injury.

 **WARNING** Indicates a potentially hazardous situation which, if not avoided, could result in death or serious injury.

 **CAUTION** Indicates a potentially hazardous situation which, if not avoided, may result in minor or moderate injury. It may also be used to alert against unsafe practices.

 **NOTE** Indicates situations that may result in equipment or property-damage accidents only.

 **INFORMATION** . . . This symbol identifies useful tips or additional information.

DANGER

- Refrigerant gas is heavier than air and replaces oxygen. A massive leak will result in oxygen depletion, especially in basements, and an asphyxiation hazard will result in serious injury or death.
- Do not ground units to water pipes, gas pipes, telephone wires, or lightning rods as incomplete grounding will result a severe shock hazard resulting in severe injury or death. Additionally, grounding to gas pipes will result a gas leak and potential explosion resulting in severe injury or death.
- If refrigerant gas leaks during installation, ventilate the area immediately. Refrigerant gas will result in producing toxic gas if it comes into contact with fire. Exposure to this gas will result in severe injury or death.
- After completing the installation work, check that the refrigerant gas does not leak throughout the system.
- Do not install unit in an area where flammable materials are present due to risk of explosions that will result in serious injury or death.
- Safely dispose all packing and transportation materials in accordance with federal/state/local laws or ordinances. Packing materials such as nails and other metal or wood parts, including plastic packing materials used for transportation will result in injuries or death by suffocation.

WARNING

- Only qualified personnel must carry out the installation work. Installation must be done in accordance with this installation manual. Improper installation could result in water leakage, electric shock, or fire.
- When installing the unit in a small room, take measures to keep the refrigerant concentration from exceeding allowable safety limits. Excessive refrigerant leaks, in the event of an accident in a closed ambient space, could result in oxygen deficiency.
- Use only specified accessories and parts for installation work. Failure to use specified parts could result in water leakage, electric shocks, fire, or the unit falling.
- Install the air conditioner or heat pump on a foundation strong enough that it can withstand the weight of the unit. A foundation of insufficient strength could result in the unit falling and causing injuries.
- Take into account strong winds, typhoons, or earthquakes when installing. Improper installation could result in the unit falling and causing accidents.
- Make sure that a separate power supply circuit is provided for this unit and that all electrical work is carried out by qualified personnel according to local, state and national regulations. An insufficient power supply capacity or improper electrical construction could result in electric shocks or fire.
- Make sure that all wiring is secured, that specified wires are used, and that no external forces act on the terminal connections or wires. Improper connections or installation could result in fire.
- When wiring, position the wires so that the control box cover can be securely fastened. Improper positioning of the control box cover could result in electric shocks, fire, or the terminals overheating.
- Before touching electrical parts, turn off the unit.
- This equipment can be installed with a Ground-Fault Circuit Interrupter (GFCI). Although this is a recognized measure for additional protection, with the grounding system in North America, a dedicated GFCI is not necessary.
- Securely fasten the unit terminal cover (panel). If the terminal cover/panel is not installed properly, dust or water may enter the outdoor unit and could result in fire or electric shock.
- When installing or relocating the system, keep the refrigerant circuit free from substances other than the specified refrigerant (R410A) such as air. Any presence of air or other foreign substance in the refrigerant circuit could result in abnormal pressure rise or rupture, resulting in injury.
- Do not change the setting of the protection devices. If the pressure switch, thermal switch, or other protection device is shorted and operated forcibly, or parts other than those specified by Daikin are used, fire or explosion could result.

⚠ CAUTION

- Do not touch the switch with wet fingers. Touching a switch with wet fingers may result in electric shock.
- Do not allow children to play on or around the unit or it may result in injury.
- The heat exchanger fins are sharp enough to cut, and may result in injury if improperly used. To avoid injury wear glove or cover the fins when working around them.
- Do not touch the refrigerant pipes during and immediately after operation as the refrigerant pipes may be hot or cold, depending on the condition of the refrigerant flowing through the refrigerant piping, compressor, and other refrigerant cycle parts. It may result in your hands getting burns or frostbite if you touch the refrigerant pipes. To avoid injury, give the pipes time to return to normal temperature or, if you must touch them, be sure to wear proper gloves.
- Install drain piping to proper drainage. Improper drain piping may result in water leakage and property damage.
- Insulate piping to prevent condensation.
- Be careful when transporting the product.
- Do not turn off the power immediately after stopping operation. Always wait for at least 5 minutes before turning off the power. Otherwise, water leakage may result.
- Do not use a charging cylinder. Using a charging cylinder may cause the refrigerant to deteriorate.
- Refrigerant R410A in the system must be kept clean, dry, and tight.
 - (a) Clean and Dry - Foreign materials (including mineral oils such as SUNISO oil or moisture) should be prevented from getting into the system.
 - (b) Tight - R410A does not contain any chlorine, does not destroy the ozone layer, and does not reduce the earth's protection against harmful ultraviolet radiation. R410A can contribute to the greenhouse effect if it is released. Therefore take proper measures to check for the tightness of the refrigerant piping installation. Read the chapter Refrigerant Piping and follow the procedures.
- Since R410A is a blend, the required additional refrigerant must be charged in its liquid state. If the refrigerant is charged in a state of gas, its composition can change and the system will not work properly.
- The indoor unit is for R410A. See the catalog for indoor models that can be connected. Normal operation is not possible when connected to other units.
- Remote controller (wireless kit) transmitting distance can be shorter than expected in rooms with electronic fluorescent lamps (inverter or rapid start types). Install the indoor unit far away from fluorescent lamps as much as possible.
- Indoor units are for indoor installation only. Outdoor units can be installed either outdoors or indoors. This unit is for indoor use.
- Do not install the air conditioner or heat pump in the following locations:
 - (a) Where a mineral oil mist or oil spray or vapor is produced, for example, in a kitchen.
Plastic parts may deteriorate and fall off and thus may result in water leakage.
 - (b) Where corrosive gas, such as sulfurous acid gas, is produced.
Corroding copper pipes or soldered parts may result in refrigerant leakage.
- (c) Near machinery emitting electromagnetic waves.
Electromagnetic waves may disturb the operation of the control system and cause the unit to malfunction.
- (d) Where flammable gas may leak, where there is carbon fiber, or ignitable dust suspension in the air, or where volatile flammables such as thinner or gasoline are handled. Operating the unit in such conditions may result in a fire.
- Take adequate measures to prevent the outdoor unit from being used as a shelter by small animals. Small animals making contact with electrical parts may result in malfunctions, smoke, or fire. Instruct the customer to keep the area around the unit clean.

⚠ NOTE

- Install the power supply and transmission wires for the indoor and outdoor units at least 3.5 ft. (1 m) away from televisions or radios to prevent image interference or noise. Depending on the radio waves, a distance of 3.5 ft. (1 m) may not be sufficient to eliminate the noise.
- Dismantling the unit, treatment of the refrigerant, oil and additional parts must be done in accordance with the relevant local, state, and national regulations.
- Do not use the following tools that are used with conventional refrigerants: gauge manifold, charge hose, gas leak detector, reverse flow check valve, refrigerant charge base, vacuum gauge, or refrigerant recovery equipment.
- If the conventional refrigerant and refrigerator oil are mixed in R410A, the refrigerant result in deterioration.
- This air conditioner or heat pump is an appliance that should not be accessible to the general public.
- As design pressure is 478 psi (3.3 MPa), the wall thickness of field-installed pipes should be selected in accordance with the relevant local, state, and national regulations.

Codes and Regulations

This product is designed and manufactured to comply with national codes. Installation in accordance with such codes and/or prevailing local codes/regulations is the responsibility of the installer. The manufacturer assumes no responsibility for equipment installed in violation of any codes or regulations. Rated performance is achieved after 72 hours of operation.

Make sure to use a DAIKIN specified checker while measuring sub cooling. Do not use the check valve or the other port to measure it.



REYQ72TTJU	REYQ288TTJU	REYQ72TYDN	REYQ288TYDN
REYQ96TTJU	REYQ312TTJU	REYQ96TYDN	REYQ312TYDN
REYQ120TTJU	REYQ336TTJU	REYQ120TYDN	REYQ336TYDN
REYQ144TTJU	REYQ360TTJU	REYQ144TYDN	REYQ360TYDN
REYQ168TTJU	REYQ384TTJU	REYQ168TYDN	REYQ384TYDN
REYQ192TTJU	REYQ408TTJU	REYQ192TYDN	REYQ408TYDN
REYQ216TTJU	REYQ432TTJU	REYQ216TYDN	REYQ432TYDN
REYQ240TTJU	REYQ456TTJU	REYQ240TYDN	REYQ456TYDN
REYQ264TTJU		REYQ264TYDN	

VRVIV System air conditioner
Installation Manual

CONTENTS

Safety considerations	i		
Codes and Regulations.....	ii		
1. Introduction	2		
1.1. General information.....	2		
1.2. Combinations and options.....	2		
1.3. Indoor capacity range.....	3		
1.4. Scope of the manual	3		
2. Accessories	3		
2.1. Accessories supplied with this unit.....	3		
3. Overview of unit	3		
3.1. Opening the unit.....	3		
3.2. Technical and Electrical specifications....	4		
3.3. Main components.....	4		
4. Selecting an installation location	4		
4.1. General precautions on installation.....	4		
4.2. Weather related precautions	4		
4.3. Selecting a location in cold climates	5		
5. Dimensions and service space	5		
5.1. Dimensions of outdoor unit	5		
5.2. Service space.....	6		
6. Inspecting, handling and unpacking the unit	7		
6.1. Inspection.....	7		
6.2. Handling	7		
6.3. Unpacking	7		
6.4. Installing the unit.....	7		
6.5. Method for removing shipping plates	8		
7. Refrigerant pipe size and allowable pipe length	9		
7.1. General information.....	9		
7.2. Selection of piping material.....	9		
7.3. Selection of piping size	9		
7.4. Selection of refrigerant branch kits.....	10		
7.5. System piping (length) limitations	11		
8. Precautions on refrigerant piping.....	14		
8.1. Caution for brazing.....	14		
8.2. Connecting the refrigerant piping	14		
8.3. Guidelines for handling stop valve.....	17		
9. Field wiring	18		
9.1. Power circuit, safety device and cable requirements	19		
9.2. Wiring connection example for whole system.....	19		
9.3. Leading wire procedure.....	19		
9.4. Transmission wiring connection procedure	20		
9.5. Power wiring connection procedure	21		
9.6. Procedure for Wiring Inside Units.....	22		
10. Air tight test and vacuum drying	22		
11. Pipe insulation.....	23		
12. Checking of device and installation conditions	24		
13. Making field settings.....	24		
13.1. Accessing the push buttons on the printed circuit board.....	24		
13.2. Operating the push buttons and DIP switches on the printed circuit board.....	24		
13.3. Connecting the PC configurator to the outdoor unit	26		
14. Charging refrigerant.....	26		
14.1. Precautions	26		
14.2. Calculating the additional refrigerant charge	26		
14.3. Method for adding refrigerant.....	28		
15. Start-up and configuration	32		
15.1. Checks before initial start up	32		
15.2. Monitoring function and field settings....	33		
15.3. Energy saving and optimum operation...	36		
15.4. Test operation.....	39		
15.5. Malfunction code list.....	40		
16. Operation of the unit	44		
17. Maintenance and service.....	44		
17.1. Maintenance introduction	44		
17.2. Service precautions.....	44		
17.3. Service mode operation	44		
18. Caution for refrigerant leaks	44		
18.1. Introduction	44		
19. Disposal requirements.....	45		

The original instructions are written in English. All other languages are translations of the original instructions.

1. Introduction

1.1. General information

This installation manual concerns the VRV IV REYQ-T series, full inverter driven, heat pump system.

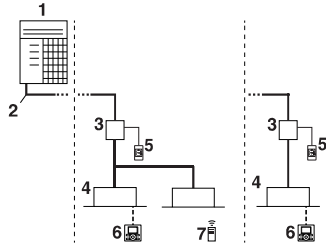

- 1 Outdoor unit
- 2 Refrigerant piping
- 3 Branch Selector unit
- 4 VRV indoor unit
- 5 Cool/Heat selector (single Branch Selector unit only)
- 6 User interface (dedicated depending on indoor unit type)
- 7 User interface (wireless, dedicated depending on indoor unit type)

i INFORMATION

Not all combinations of indoor units are allowed. For guidance, see 1.2. Combinations and options.

1.2. Combinations and options

The VRV IV REYQ-T series heat recovery system can be combined with several types of indoor units and is intended for R410A use only.

For an overview which units are available you can consult the product catalogue for VRV IV REYQ-T series.

! NOTE

To be sure your system setup (outdoor unit + Branch Selector unit(s) + indoor unit(s)) will work, you have to consult the latest technical engineering data for VRV IV REYQ-T series.

An overview is given indicating the allowed combinations of indoor units and outdoor units. Not all combinations are allowed. They are subject to rules (combination between outdoor-indoor, single outdoor unit use, multiple outdoor units use, combinations between indoor units, etc.) mentioned in the technical engineering data.

The Branch Selector units that combined with REYQ-T units for changing the refrigerant flow to indoor units are T type (BSQ-TVJ, BS-Q54TVJ) only. Do not combine the T type and P type (BSVQ-PVJU, BSV-Q36PVJU) in the system. Combination of T type and P type cause malfunction.

1.2.1. Indoor units combinations

In general VRV indoor units can be connected to REYQ-T units.

1.2.2. Outdoor units combinations

Standard combinations for REYQ-T units are as indicated in tables below and right, where REYQ192-456 consists of several REYQ72-168 modules as indicated.

	72	96	120	144	168
REYQ72TTJU/TYDN	1				
REYQ96TTJU/TYDN		1			
REYQ120TTJU/TYDN			1		
REYQ144TTJU/TYDN				1	
REYQ168TTJU/TYDN					1

	72	96	120	144	168
REYQ192TTJU/TYDN	1		1		
REYQ216TTJU/TYDN		1	1		
REYQ240TTJU/TYDN		1		1	
REYQ264TTJU/TYDN			1	1	
REYQ288TTJU/TYDN				2	
REYQ312TTJU/TYDN				1	1
REYQ336TTJU/TYDN					2
REYQ360TTJU/TYDN			3		
REYQ384TTJU/TYDN		1	1		1
REYQ408TTJU/TYDN		1		1	1
REYQ432TTJU/TYDN				3	
REYQ456TTJU/TYDN				2	1

To install the outdoor unit, the following optional parts are also required.

1 Refrigerant branch kit.

Description	Model name	
	(for 3 pipes)	(for 2 pipes)
REFNET header	KHRP25M33H9	KHRP26M22H9
	KHRP25M72H9	KHRP26M33H9
	KHRP25M73HU9	KHRP26M72H9
REFNET joint	KHRP25A22T9	KHRP26A22T9
	KHRP25A33T9	KHRP26A33T9
	KHRP25M72TU9	KHRP26M72TU9
	KHRP25M73TU9	—

For the selection of the optimal branch kit, refer to 7.4. Selection of refrigerant branch kits on page 10.

2 Outdoor unit multi connection piping kit.

Number of outdoor units connected	
2	3
BHFP26P100U	BHFP26P151U

- 3 In order to control the cooling or heating operation from a central location, the following option can be connected:
 - Cool/Heat selector: KRC19-26A
 - With optional fixing box for the switch: KJB111A
 - Centralized control devices (e.g., intelligent Touch Manager)
- 4 To instruct specific operation with an external input coming from a central control the external control adaptor (DTA104A61/62) can be used. Instructions (group or individual) can be instructed for low noise operation and power consumption limitation operation.
- 5 For REYQ-T units it is also possible to make several commissioning field settings through a personal computer interface. For this option EKPCAB* is required which is a dedicated cable to communicate with the outdoor unit. The software for the user interface program can be obtained from your local Daikin sales office.

i INFORMATION

Refer to the technical engineering data for the latest option names.

1.3. Indoor capacity range

Total capacity of indoor units needs to be within the specified range.

<Outdoor unit>	<Total capacity index of indoor units>
REYQ72TTJU/TYDN	36-93
REYQ96TTJU/TYDN	48-124
REYQ120TTJU/TYDN	60-156
REYQ144TTJU/TYDN	72-187
REYQ168TTJU/TYDN	84-218
REYQ192TTJU/TYDN	96-249
REYQ216TTJU/TYDN	108-280
REYQ240TTJU/TYDN	120-312
REYQ264TTJU/TYDN	132-343
REYQ288TTJU/TYDN	144-374
REYQ312TTJU/TYDN	156-405
REYQ336TTJU/TYDN	168-436
REYQ360TTJU/TYDN	180-468
REYQ384TTJU/TYDN	192-499
REYQ408TTJU/TYDN	204-530
REYQ432TTJU/TYDN	216-561
REYQ456TTJU/TYDN	228-592

NOTE
Higher capacity than the above table can be selected, this may affect heating and cooling capacity. For additional information see technical engineering data.

1.4. Scope of the manual

This manual describes the procedures for handling, installing and connecting the VRV IV REYQ-T series outdoor units. This manual has been prepared to ensure adequate maintenance of the unit, and it will provide help in case problems occur.

INFORMATION
The installation of the indoor unit(s) is described in the indoor unit installation manual provided with the indoor unit(s).

2. Accessories

2.1. Accessories supplied with this unit

Confirm the following accessories are included. The storage location of the accessories is shown in the figure below.

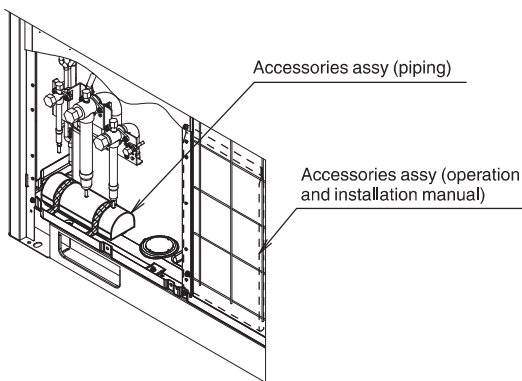

NOTE
Do not throw away any of the accessories until installation is complete. They are needed for installation work.

Name	Clamp (1)	Clamp (2)	Clamp (3)	Vinyl tube	Manuals, etc.
Quantity	7 pcs.	1 pc.	1 pc.	5 pcs.	1 pc. each
Shape					<ul style="list-style-type: none"> Operation Manual Installation Manual REQUEST FOR THE INDICATION label (Installation records)

Name	Liquid side accessory pipe (1)	Liquid side accessory pipe (2)	Gas side accessory pipe (1)	Gas side accessory pipe (2)
Quantity	1 pc.	1 pc.	1 pc.	1 pc.
Shape				

Name	High and low gas side accessory pipe (1)	High and low gas side accessory pipe (2)	L type accessory joint
Quantity	1 pc.	1 pc.	2 pcs.
Shape			

3. Overview of unit

3.1. Opening the unit

To gain access to the unit, front panels need to be opened as follows:

REYQ72TTJU/TYDN

REYQ96-168TTJU/TYDN

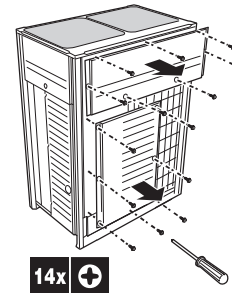
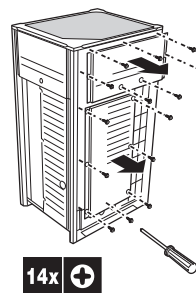

Once the front panel open, the control box can be accessed by removing the control box cover as follows.

REYQ72TTJU/TYDN

REYQ96-168TTJU/TYDN

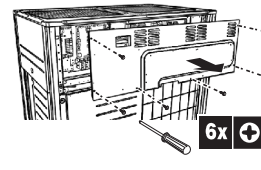
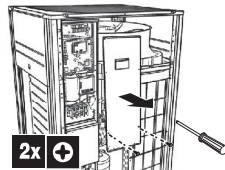

For service purposes, the push buttons on the main printed circuit board need to be accessed. To access these push buttons, the control box cover does not need to be opened. See 13. Making field settings on page 24.

DANGER: ELECTRICAL SHOCK
See Safety considerations on page i.

DANGER: DO NOT TOUCH PIPING AND INTERNAL PARTS
See Safety considerations on page i.

3.2. Technical and Electrical specifications

Refer to the Engineering Data Book for the complete list of specifications.

3.3. Main components

For main components and function of the main components, refer to the Engineering Data Book.

4. Selecting an installation location

⚠ WARNING

Be sure to provide for adequate measures in order to prevent that the unit is used as a shelter by small animals.

Small animals making contact with electrical parts can cause malfunctions, smoke or fire. Please instruct the customer to keep the area around the unit clean and clear.

In a domestic environment this product may cause radio interference in which case the user may be required to take adequate measures.

⚠ CAUTION

Appliance not accessible to the general public, install it in a secured area, protected from easy access.

This unit, both indoor and outdoor, is suitable for installation in a commercial and light industrial environment.

4.1. General precautions on installation

Select an installation site that meets the following requirements:

- The foundation must be strong enough to support the weight of the unit.
- Installation location is flat to prevent vibrations and noise generation and to have sufficient stability.
- The space around the unit is adequate for maintenance and servicing (refer to 5.2. Service space on page 6).
- The space around the unit allows for sufficient air circulation.
- There is no danger of fire due to leakage of inflammable gas.
- The equipment is not intended for use in a potentially explosive atmosphere.
- Select the location of the unit in such a way that the sound generated by the unit does not disturb anyone, and the location is selected according to the applicable legislation.
- All piping lengths and distances have been taken into consideration (refer to 7.5. System piping (length) limitations on page 11).
- Take care that in the event of a water leak, water cannot cause any damage to the installation space and surroundings.
- When installing the unit in a small room, take measures in order to keep the refrigerant concentration from exceeding allowable safety limits in the event of a refrigerant leak, refer to 18. Caution for refrigerant leaks on page 44.

⚠ CAUTION

Excessive refrigerant concentrations in a closed room can lead to oxygen deficiency.

⚠ NOTE

The equipment described in this manual may cause electronic noise generated from radio-frequency energy. The equipment complies to specifications that are designed to provide reasonable protection against such interference. However, there is no guarantee that interference will not occur in a particular installation.

It is therefore recommended to install the equipment and electric wires keeping proper distances away from stereo equipment, personal computers, etc

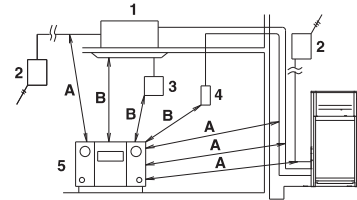

- 1 Indoor unit
 - 2 Branch switch, overcurrent breaker
 - 3 Remote controller
 - 4 Cool/Heat selector
 - 5 Personal computer or radio
- A ≥ 60 in. (1500 mm)
B ≥ 40 in. (1000 mm)

An inverter air conditioner may cause electronic noise generated from AM broadcasting. Examine where to install the main air conditioner and electric wires, keeping proper distances away from stereo equipment, personal computers, etc.

Particularly for locations with weak reception, ensure there is a distance of at least 10 ft. (3 m) for indoor remote controllers, place power wiring and transmission wiring in conduits, and ground the conduits.

- The refrigerant R410A itself is nontoxic, non-flammable and is safe. If the refrigerant should leak however, its concentration may exceed the allowable limit depending on room size. Due to this, it could be necessary to take measures against leakage. Refer to 18. Caution for refrigerant leaks on page 44.
- Do not install in the following locations:
 - Locations where sulfurous acids and other corrosive gases may be present in the atmosphere. Copper piping and soldered joints may corrode, causing refrigerant to leak.
 - Locations where a mineral oil mist, spray or vapor may be present in the atmosphere. Plastic parts may deteriorate and fall off or cause water leakage.
 - Locations where equipment that produces electromagnetic waves is found. The electromagnetic waves may cause the control system to malfunction, preventing normal operation.
 - Locations where flammable gases may leak, where thinner, gasoline and other volatile substances are handled, or where carbon dust and other incendiary substances are found in the atmosphere. Leaked gas may accumulate around the unit, causing an explosion.
- When installing, take strong winds, hurricanes or earthquakes into account, improper installation may result in the unit turning over.

4.2. Weather related precautions

- Select a place where the rain can be avoided as much as possible.
- Be sure that the air inlet of the unit is not positioned towards the main wind direction. Frontal wind will disturb the operation of the unit. If necessary, use a screen to block the wind.
- Ensure that water cannot cause any damage to the location by adding water drains to the foundation and prevent water traps in the construction.
- Do not install the unit in areas where the air contains high levels of salt such as that near the ocean.

4.3. Selecting a location in cold climates

NOTE

- When operating the unit in a low outdoor ambient temperature, be sure to follow the instructions described below.
- The following images are for reference only. For more details contact your local dealer.

To prevent exposure to wind and snow, install a baffle plates on the air side of the outdoor unit (see 5.2. Service space for space requirement):

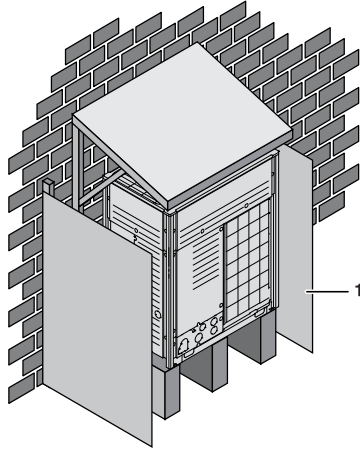

1 Baffle plates

In heavy snowfall areas it is very important to select an installation site where the snow will not affect the unit. If lateral snowfall is possible, make sure that the heat exchanger coil is not affected by the snow (if necessary construct a lateral canopy). Install the unit high enough from the ground to prevent burying in snow.

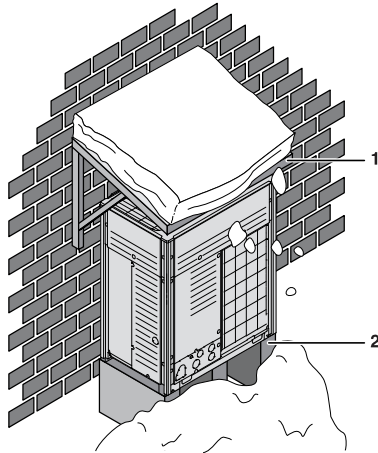

- 1 Construct a large canopy.
- 2 Construct a pedestal.

NOTE

When operating the unit in a low outdoor ambient temperature with high humidity conditions, make sure to take precautions to keep the drainholes of the unit free by using proper equipment such as the optional drainpan heater. For more information contact your local dealer.

5. Dimensions and service space

5.1. Dimensions of outdoor unit

REYQ72TTJU/TYDN

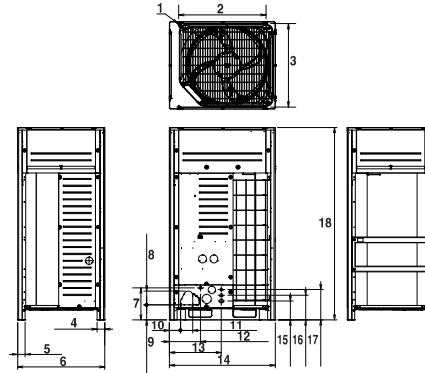

REYQ96-168TTJU/TYDN

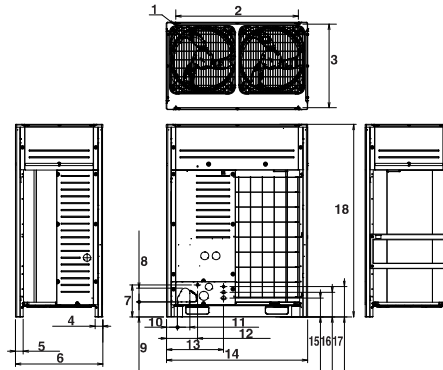

Unit: in. (mm)

	REYQ72TTJU/TYDN	REYQ96-168TTJU/TYDN
1	Foundation bolt holes 9/16 (15) × 7/8 (22.5) oblong holes × 4	
2	Pitch of foundation bolt holes 30-3/16 (766) 42-3/8 (1076)	
3	Pitch of foundation bolt holes 28-7/16 to 29 (722 to 737)	
4	2-5/8 (67)	
5	2-5/8 (67)	
6	30-3/16 (767)	
7	11-1/8 (282)	
8	4-13/16 (122)	
9	5-3/16 (132)	
10	3-7/8 (98)	
11	4-3/16 (107)	
12	10-11/16 (272)	
13	18-1/16 (458)	19-3/4 (502)
14	36-11/16 (932)	48-7/8 (1242)
15	6-9/16 (167)	
16	8-9/16 (217)	
17	10-1/2 (267)	
18	66-11/16 (1694)	

5.2. Service space

The space around the unit is adequate for servicing and the minimum space for air inlet and air outlet is available (refer to the figure below and choose one of the possibilities).

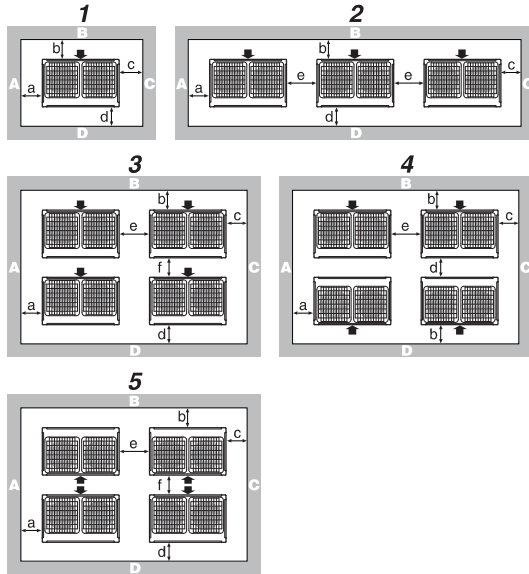

ABCD Sides along the installation site with obstacles
 ↕ Suction side

	A+B+C+D		A+B
1	a ≥ 3/8 (10) b ≥ 11-3/4 (300) c ≥ 3/8 (10) d ≥ 19-5/8 (500)	a ≥ 2 (50) b ≥ 3-7/8 (100) c ≥ 2 (50) d ≥ 19-5/8 (500)	a ≥ 7-7/8 (200) b ≥ 11-3/4 (300)
2	a ≥ 3/8 (10) b ≥ 11-3/4 (300) c ≥ 3/8 (10) d ≥ 19-5/8 (500) e ≥ 3/4 (20)	a ≥ 2 (50) b ≥ 3-7/8 (100) c ≥ 2 (50) d ≥ 19-5/8 (500) e ≥ 3-7/8 (100)	a ≥ 7-7/8 (200) b ≥ 11-3/4 (300) e ≥ 15-3/4 (400)
3	a ≥ 3/8 (10) b ≥ 11-3/4 (300) c ≥ 3/8 (10) d ≥ 19-5/8 (500) e ≥ 3/4 (20) f ≥ 23-5/8 (100)	a ≥ 2 (50) b ≥ 3-7/8 (100) c ≥ 2 (50) d ≥ 19-5/8 (500) e ≥ 3-7/8 (100) f ≥ 19-5/8 (500)	Unit: in.(mm)
4	a ≥ 3/8 (10) b ≥ 11-3/4 (300) c ≥ 3/8 (10) d ≥ 19-5/8 (500) e ≥ 3/4 (20)	a ≥ 2 (50) b ≥ 3-7/8 (100) c ≥ 2 (50) d ≥ 19-5/8 (500) e ≥ 3-7/8 (100)	
5	a ≥ 3/8 (10) b ≥ 19-5/8 (500) c ≥ 3/8 (10) d ≥ 19-5/8 (500) e ≥ 3/4 (20) f ≥ 35-7/16 (900)	a ≥ 2 (50) b ≥ 19-5/8 (500) c ≥ 2 (50) d ≥ 19-5/8 (500) e ≥ 3-7/8 (100) f ≥ 23-5/8 (600)	

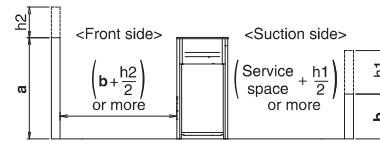

- a 59 in. (1500 mm)
- b 19-5/8 in. (500 mm)

- In case of an installation site where sides A+B+C+D have obstacles, the wall heights of sides A+C have no impact on service space dimensions. Refer to the foregoing figure for impact of wall heights of sides B+D on service space dimensions.
- In case of an installation site where only the sides A+B have obstacles, the wall heights have no influence on any indicated service space dimensions.
- The installation space required on these drawings are for full load heating operation without considering possible ice accumulation. If the location of the installation is in a cold climate, then all dimensions above should be >19-5/8 in. (500 mm) to avoid accumulation of ice in between the outdoor units.

i INFORMATION

- The service space dimensions in above figure are based on cooling operation at 95°F (35°C) ambient temperature (standard conditions).
- If the design outdoor temperature exceeds 95°F (35°C) or the heat load exceeds maximum capacity in all the outdoor unit, take an even large space on the intake shown in figure in 5.2. Service space.

i INFORMATION

Further specifications can be found in the Engineering Data Book.



6. Inspecting, handling and unpacking the unit

6.1. Inspection

At delivery, the unit must be checked and any damage must be reported immediately to the carrier's claims agent.

6.2. Handling

1 When handling the unit, take into account the following:

-  Fragile, handle the unit with care.
-  Keep the unit upright in order to avoid compressor damage.

- 2 Choose beforehand the path along which the unit is to be brought in.
- 3 Bring the unit as close as possible to its final installation position in its original package to prevent damage during transport.

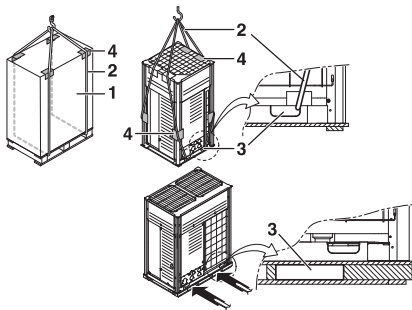

- 1 Packaging material
- 2 Belt sling
- 3 Opening
- 4 Protector

- 4 Lift the unit preferably with a crane and 2 belts of at least 27 ft. (8 m) long as shown in the figure above. Always use protectors to prevent belt damage and pay attention to the position of the unit's center of gravity.

NOTE
Use a belt sling of $\leq 3/4$ in. (20 mm) wide that adequately bears the weight of the unit.

A forklift can only be used for transport as long as the unit remains on its pallet as shown above.

6.3. Unpacking

CAUTION
To avoid injury, do not touch the air inlet or aluminum fins of the unit.

WARNING
Tear apart and throw away plastic packaging bags so that children will not play with them. Children playing with plastic bags face danger of death by suffocation.

- 1 Remove the 4 bolts fixing the unit to its pallet.
- 2 Make sure that all accessories as mentioned in 2.1. Accessories supplied with this unit on page 3 are available in the unit.

6.4. Installing the unit

Make sure the unit is installed level on a sufficiently strong base to prevent vibration and noise.

NOTE
When the installation height of the unit needs to be increased, do not use stands to only support the corners.

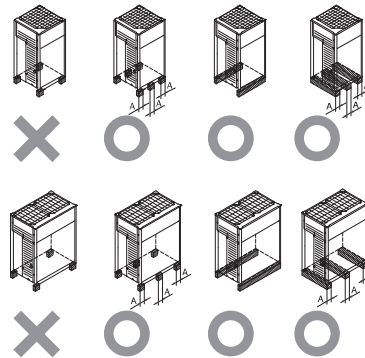

- A $\geq 3-7/8$ in. (100 mm)
- X Not allowed
- O Allowed

- The height of the foundation must be at least 5-7/8 in. (150 mm) from the floor.
In heavy snowfall areas, this height should be increased, depending on the installation place and condition.
- The unit must be installed on a solid longitudinal foundation (steel beam frame or concrete) and make sure the base under the unit is larger than the gray marked area.

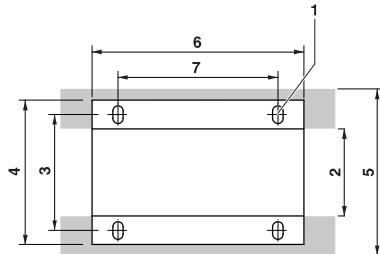

Dimensions for above figure		
1	Hole for foundation bolt	φ9/16 in. (15 mm) dia: 4 positions
2	Inner dimension of the base	24-7/8 in. (631 mm)
3	Distance between foundation bolt holes	29 in. (729 mm)
4	Depth of unit	30-1/8 in. (765 mm)
5	Outer dimension of the base	≥30-1/8 in. (765 mm)
6	Longitudinal foundation dimension	72T type: 36-9/6 in. (930 mm)
		96-168T type: 48-13/16 in. (1240 mm)
7	Distance between foundation bolt holes	72T type: 30-3/16 in. (766 mm)
		96-168T type: 42-3/8 in. (1076 mm)

- Fasten the unit in place using 4 foundation bolts 7/16 in. (M12). It is best to screw in the foundation bolts until their length remains 13/16 in. (20 mm) above the foundation surface.

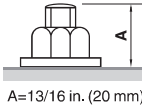

NOTE

- There are restrictions on the refrigerant pipe connecting order between outdoor units in the case of the multi system. See 1.2.2. Outdoor units combinations on page 2 for detail.
- When installing on a roof, make sure the roof floor is strong enough and be sure to waterproof all work.
- Make sure the area around the machine drains properly by setting up drainage grooves around the foundation.
- Drain water is sometimes discharged from the outdoor unit when it is running.
- For anti-corrosion type, use nuts with resin washers. If the paint on nut connections comes off, the anti-corrosion effect may decrease.

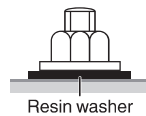

6.5. Method for removing shipping plates

The shipping plates installed over the compressor legs for protecting the unit during transport must be removed. Proceed as shown in the figure and procedure below.

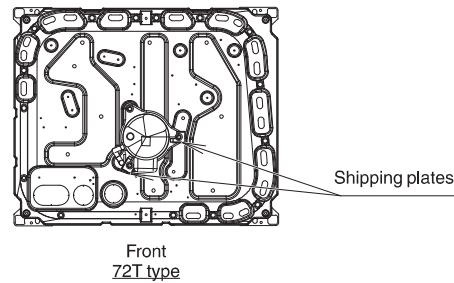
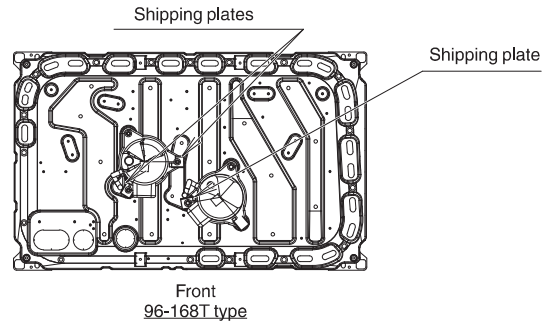

- 1 Remove shipping plates.
- 2 Be sure to tighten compressor fixing bolts again. (9.1ft-lbf (12.3 N-m))

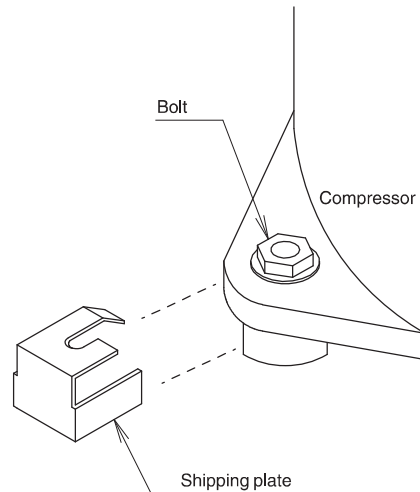

NOTE

If the unit is operated with the shipping plates still attached, abnormal vibration or noise may be generated.

7. Refrigerant pipe size and allowable pipe length

7.1. General information

- NOTE**
- The refrigerant R410A requires strict cautions for keeping the system clean, dry and tight.
- Clean and dry: foreign materials (including mineral oils or moisture) should be prevented from getting mixed into the system.
 - Tight: R410A does not contain any chlorine, does not destroy the ozone layer, and does not reduce earth's protection against harmful ultraviolet radiation. R410A can contribute slightly to the greenhouse effect if it is released. Therefore we should take special attention to check the tightness of the installation.

7.2. Selection of piping material

- NOTE**
- Piping and other pressure containing parts shall comply with the applicable legislation and shall be suitable for refrigerant. Use phosphoric acid deoxidized seamless copper for refrigerant.

- NOTE**
- All field piping must be installed by a licensed refrigeration technician and must comply with relevant local and national regulations.
 - After piping work is complete, do not under any circumstances open the stop valve until 9. Field wiring on page 18 and 12. Checking of device and installation conditions on page 24 are complete.
 - Do not use flux when brazing the refrigerant piping. Use the phosphor copper brazing filler metal (B-Cu93P-710/795 : ISO 3677) which does not require flux. Flux has extremely negative effect on refrigerant piping systems. For instance, if the chlorine based flux is used, it will cause pipe corrosion or, in particular, if the flux contains fluorine, it will damage the refrigerant oil.

- Use only pipes which are clean inside and outside and which do not accumulate harmful sulfur, oxidants, dirt, cutting oils, moisture, or other contamination. (Foreign materials inside pipes including oils for fabrication must be 0.14 gr/10 ft. (30 mg/10 m) or less.)
- Use the following items for the refrigerant piping.
 - Material** : Jointless phosphor-deoxidized copper pipe.
 - Size** : See 7.3. Selection of piping size to determine the correct size.
 - Thickness** : Select a thickness for the refrigerant piping which complies with national and local laws.
- For piping work, follow the maximum tolerated length, difference in height, and length after a branch indicated in the 7.5. System piping (length) limitations on page 11.
- Outdoor unit multi connection piping kit and refrigerant branch kit (sold separately) are needed for connection of piping between outdoor units (in case of multi system) and piping branches.
- Use only separately sold items selected specifically according to the outdoor unit multi connection piping kit, the refrigerant branch kit selection in the 7.4. Selection of refrigerant branch kits on page 10.

7.3. Selection of piping size

Determine the proper size referring to following tables and reference figure (only for indication).

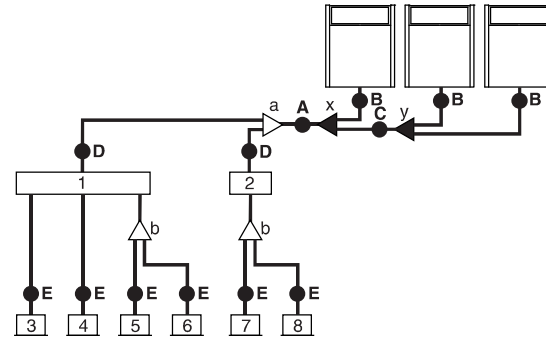

- 1 Multi Branch Selector unit
- 2 Single Branch Selector unit
- 3-8 VRV indoor units
- a, b Refrigerant branch kits
- x, y Outdoor unit multi connection piping kits

7.3.1. Piping between outdoor units and (first) refrigerant branch kit: A, B, C

Choose from the following table in accordance with the outdoor unit total capacity type, connected downstream.

Outdoor unit capacity type	Piping outer diameter size		
	Suction gas pipe	High/low pressure gas pipe	Liquid pipe
REYQ72T type	3/4 in. (19.1 mm)	5/8 in. (15.9 mm)	3/8 in. (9.5 mm)
REYQ96T type	7/8 in. (22.2 mm)	3/4 in. (19.1 mm)	
REYQ120T type	1-1/8 in. (28.6 mm)	7/8 in. (22.2 mm)	1/2 in. (12.7 mm)
REYQ144T type		1-1/8 in. (28.6 mm)	5/8 in. (15.9 mm)
REYQ168T type			
REYQ192,216T type	1-3/8 in. (34.9 mm)	1-1/8 in. (28.6 mm)	3/4 in. (19.1 mm)
REYQ240T type			
REYQ264-336T type	1-5/8 in. (41.3 mm)	1-3/8 in. (34.9 mm)	

7.3.2. Piping between refrigerant branch kits or refrigerant branch kits and Branch Selector units: D

Choose from the following table in accordance with the indoor unit total capacity, connected downstream. Do not let the connection piping exceed the refrigerant piping size chosen by the general system model name.

Indoor unit capacity index	Piping outer diameter size		
	Suction gas pipe	High/low pressure gas pipe	Liquid pipe
< 54	5/8 in. (15.9 mm)	1/2 in. (12.7 mm)	3/8 in. (9.5 mm)
54 ≤ x < 72	3/4 in. (19.1 mm)	5/8 in. (15.9 mm)	
72 ≤ x < 111	7/8 in. (22.2 mm)	3/4 in. (19.1 mm)	1/2 in. (12.7 mm)
111 ≤ x < 162	1-1/8 in. (28.6 mm)		5/8 in. (15.9 mm)
162 ≤ x < 230		1-3/8 in. (34.9 mm)	1-1/8 in. (28.6 mm)
230 ≤ x < 300	1-5/8 in. (41.3 mm)		
> 300			

Example:

Downstream capacity for D = capacity index of (unit 3 + unit 4 + unit 5 + unit 6)

7.3.3. Piping between refrigerant branch kits or Branch Selector units and indoor units: E

Pipe size for direct connection to indoor units must be the same as the connection size of the VRV indoor units.

Indoor unit capacity index	Piping outer diameter size	
	Gas pipe	Liquid pipe
07, 09, 12, 18	1/2 in. (12.7 mm)	1/4 in. (6.4 mm)
24, 30, 36, 42, 48, 54	5/8 in. (15.9 mm)	3/8 in. (9.5 mm)
72	3/4 in. (19.1 mm)	
96	7/8 in. (22.2 mm)	

7.4. Selection of refrigerant branch kits

For piping example, refer to 7.3. Selection of piping size on page 9.

- When using REFNET joints at the first branch from the outdoor units, choose from the following table in accordance with the capacity of the outdoor unit (example: REFNET joint a - see 7.3. Selection of piping size).

Outdoor unit capacity type	Kit name
REYQ 72, 96T type	KHRP25A33T9
REYQ 120-216T type	KHRP25M72TU9
REYQ 240-456T type	KHRP25M73TU9

For REFNET joints other than the first branch (example REFNET joint b - see 7.3. Selection of piping size), select the proper branch kit model based on the total capacity of all indoor units connected after the refrigerant branch.

Indoor unit capacity index	Kit name	
	(for 3 pipes)	(for 2 pipes)
< 72	KHRP25A22T9	KHRP26A22T9
72 ≤ x < 111	KHRP25A33T9	KHRP26A33T9
111 ≤ x < 246	KHRP25M72TU9	KHRP26M72TU9
≥ 246	KHRP25M73TU9	KHRP26M73TU9

- Concerning REFNET headers, choose from the following table in accordance with the total capacity of all the indoor units connected after the REFNET header.

Indoor unit capacity index	Kit name	
	(for 3 pipes)	(for 2 pipes)
< 72	KHRP25M33H9	KHRP26M22H9: maximum 4 indoor units or KHRP26M33H9: maximum 8 indoor units
72 ≤ x < 111		KHRP26M33H9
111 ≤ x < 230	KHRP25M72H9	KHRP26M72H9
≥ 230	KHRP25M73HU9	KHRP26M73H9

— i INFORMATION —

Maximum 8 branches can be connected to a header.

- How to choose an outdoor multi connection piping kit (needed if the outdoor unit capacity type is 192 or more). Choose from the following table in accordance with the number of outdoor units.

Number of outdoor units	Branch kit name
2	BHFP26P100U
3	BHFP26P151U

7.5. System piping (length) limitations

<Example of refrigerant piping (8 indoor units are connected)>

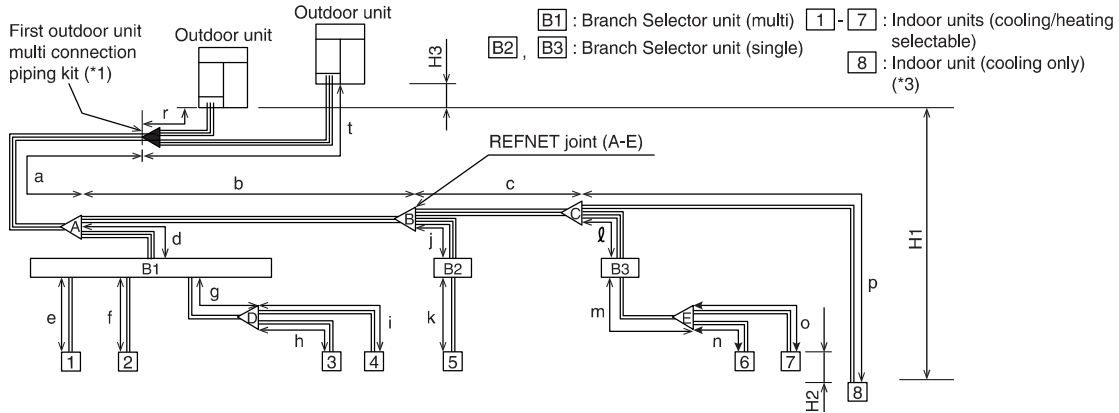

(*1) "≡" represents an outdoor unit multi connection piping kit.
 The outdoor unit multi connection piping kit must always be installed horizontally, paying attention to the installation restrictions indicated in **8. Precautions on refrigerant piping** on page 14.

<Example of connection>



(1) Piping from outdoor units to Branch Selector units

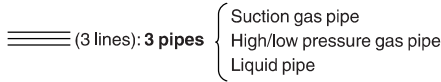

(2) Piping from Branch Selector units to the indoor units, and from refrigerant branch kits to the cooling-only indoor units (*2)



(*2) The 2-line gas pipe that is branched from the 3-line pipe and goes to the cooling-only indoor units should be connected to the suction gas pipe.
 (*3) Cooling-only units should make up ≤50% of the total capacity of indoor units.

Maximum allowable length	From outdoor unit (*4) to indoor unit	Actual piping length	Actual piping length from the outdoor unit (*4) to the indoor unit: ≤540 ft. (165 m) (Example) [4]: a+d+g+i≤540 ft. (165 m), [7]: a+b+c+l+m+o≤540 ft. (165 m), [8]: a+b+c+p≤540 ft. (165 m)					
		Equivalent length	Equivalent piping length from the outdoor unit (*4) to the indoor unit: ≤623 ft. (190 m) (*6) (Calculate the equivalent piping length for the REFNET joint as 1.6 ft. (0.5 m), REFNET header as 3.3 ft. (1 m), BS4-6Q54TVJ as 19 ft. (6 m), BS8 to 12Q54TVJ as 33 ft. (10 m), BSQ36-60TVJ as 13 ft. (4 m), and BSQ96TVJ as 19 ft. (6 m).)					
		Total extension	Total actual piping length from the outdoor unit (*4) to all indoor units: ≤3280 ft. (1000 m)					
Allowable height difference	From outdoor unit to indoor unit	Height difference	Height difference between outdoor unit and indoor unit (H1): ≤164 ft. (50 m) (if outdoor unit is lower than indoor unit, ≤130 ft. (40 m)) (*7)					
	From indoor unit to indoor unit	Height difference	<table border="1"> <tr> <td>Actual piping length X</td> <td>Height difference between indoor units (H2)</td> </tr> <tr> <td>X ≤ 540 ft. (165 m)</td> <td>≤ 49 ft. (15 m)</td> </tr> <tr> <td>X ≤ 390 ft. (120 m)</td> <td>≤ 98 ft. (30 m)</td> </tr> </table>	Actual piping length X	Height difference between indoor units (H2)	X ≤ 540 ft. (165 m)	≤ 49 ft. (15 m)	X ≤ 390 ft. (120 m)
Actual piping length X	Height difference between indoor units (H2)							
X ≤ 540 ft. (165 m)	≤ 49 ft. (15 m)							
X ≤ 390 ft. (120 m)	≤ 98 ft. (30 m)							
Allowable length after branch (*5)	From first outdoor unit multi connection piping kit to outdoor unit (in a multi system)	Actual piping length Equivalent length	Actual piping length from the first outdoor unit multi connection piping kit to the outdoor unit: ≤33 ft. (10 m) Equivalent piping length from the first outdoor unit multi connection piping kit to the outdoor unit: ≤43 ft. (13 m)					
	From outdoor unit to outdoor unit	Height difference	Height difference between outdoor units (H3): ≤16 ft. (5 m)					
		Actual piping length	Actual piping length from the first REFNET joint or REFNET header to indoor unit: ≤130 ft. (40 m) (*8) (Example) [4]: d+g+i≤130 ft. (40 m), [7]: b+c+l+m+o≤130 ft. (40 m), [8]: b+c+p≤130 ft. (40 m)					

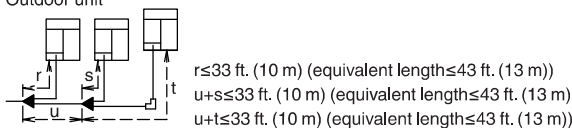

- (*4) In the case of an outdoor units multi system, "outdoor unit" should be read as the "first outdoor unit multi connection piping kit", seen from the indoor units side.
- (*5) In the case of a multi Branch Selector unit, it should be read as the "REFNET header", and the allowable length of piping should be selected. In the case where only 1 multi Branch Selector unit is included in the system, the actual piping length from each branch points of the multi Branch Selector unit to each indoor units should be ≤130 ft. (40 m).
- (*6) In the case where the equivalent piping length from outdoor units to indoor units ≥295 ft. (90 m), make sure to upsize the liquid pipe of the main pipe (see the figure below), referring to the table below. (Do not upsize the high/low pressure gas pipe and the suction gas pipe.)

Outdoor unit capacity type	Liquid pipe
REYQ72, 96T type	φ3/8 in. (9.5 mm) → φ1/2 in. (12.7 mm)
REYQ120, 144T type	φ1/2 in. (12.7 mm) → φ5/8 in. (15.9 mm)
REYQ168-240T type	φ5/8 in. (15.9 mm) → φ3/4 in. (19.1 mm)
REYQ264-456T type	φ3/4 in. (19.1 mm) → φ7/8 in. (22.2 mm)

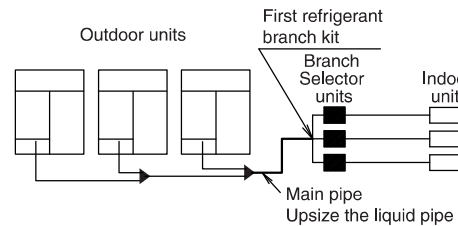

- (*7) It can be extended to ≤295 ft. (90 m) (if outdoor unit is lower than indoor unit, ≤195 ft. (60 m) by field setting). See [2-49]=Height difference setting on page 36.

(*8) When conditions listed in the table below are all satisfied, the allowable length restrictions after branch is ≤ 295 ft. (90 m).

Necessary conditions	Example: Only the allowable length after branch for the indoor unit 9 exceeds 130 ft. (40 m) in the figure in the lower right	
1. Upsize the liquid pipe from the first refrigerant branch kit to the final refrigerant branch kit for the indoor unit beyond 130 ft. (40 m). <ul style="list-style-type: none"> If upsizing is impossible, the conditions are not satisfied. If the upsized line would become larger than the main pipe, then the main pipe should also be upsized. 	Upsize the liquid pipes b, c, d, e, f and g in the figure in the right. The upsizing specifications should be as follows: $\phi 3/8$ in. (9.5 mm) \rightarrow $\phi 1/2$ in. (12.7 mm) $\phi 1/2$ in. (12.7 mm) \rightarrow $\phi 5/8$ in. (15.9 mm) $\phi 5/8$ in. (15.9 mm) \rightarrow $\phi 3/4$ in. (19.1 mm) $\phi 3/4$ in. (19.1 mm) \rightarrow $\phi 7/8$ in. (22.2 mm)	<p style="text-align: center;">$b+c+d+e+f+g+p > 130$ ft. (40 m)</p> <p>From outdoor unit to the farthest indoor unit 9 From outdoor unit to the nearest indoor unit 1</p>
2. The total piping length, calculated by doubling the piping length as upsized in 1 above, is ≤ 3280 ft. (1000 m). (The main pipe, and lines that are not upsized, should not be doubled.)	$a+b \times 2+c \times 2+d \times 2+e \times 2+f \times 2+g \times 2$ $+h+i+j+k+l+m+n+p+q+r+s$ ≤ 3280 ft. (1000 m)	
3. The actual piping length from each indoor units to the nearest refrigerant branch kit are all ≤ 130 ft. (40 m).	<ul style="list-style-type: none"> $i, j \dots, p \leq 130$ ft. (40 m) $h+q+r \leq 130$ ft. (40 m) $h+q+s \leq 130$ ft. (40 m) 	
4. The difference between the actual piping length from the outdoor unit to the farthest indoor unit, and the actual piping length from the outdoor unit to the nearest indoor unit, is ≤ 130 ft. (40 m).	Actual piping length of 9 - Actual piping length of 1 $(a+b+c+d+e+f+g+p) - (a+h+q+r)$ ≤ 130 ft. (40 m)	



In the case of a multi Branch Selector unit, if a junction pipe kit (separately sold) is used for combining 2 lines, the actual piping length between the multi Branch Selector unit and the indoor units should be ≤ 65 ft. (20 m).

8. Precautions on refrigerant piping

- Do not allow anything other than the designated refrigerant to get mixed into the refrigerant cycle, such as air, nitrogen, etc. If any refrigerant gas leaks while working on the unit, ventilate the room thoroughly right away.
- Use R410A only when adding refrigerant.
- Installation tools:
Make sure to use installation tools (gauge manifold, charge hose, etc.) that are exclusively used for R410A installations to withstand the pressure and to prevent foreign materials (e.g., mineral oils and moisture) from mixing into the system.
- Vacuum pump:
 - Use a 2-stage vacuum pump with a non-return valve.
 - Make sure the pump oil does not flow oppositely into the system while the pump is not working.
 - Use a vacuum pump which can evacuate to 500 microns.

Protection against contamination when installing pipes

Take measures to prevent foreign materials like moisture and contamination from mixing into the system.

	Installation	Protection method
	More than a month	Pinch the pipe
	Less than a month	Pinch or tape pipe
	Regardless of the period	

Block all gaps in the holes for passing out piping and wiring using sealing material (field supply) (the capacity of the unit will drop and small animals may enter the machine).

Example: passing piping out through the front.

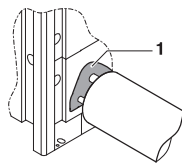

- 1 Close the areas marked with ■. (When the piping is routed from the front panel.)

- Use clean pipes only.
- Hold the pipe end downwards when removing burrs.
- Cover the pipe end when inserting it through a wall so that no dust or dirt enters the pipe.

NOTE

- After all the piping has been connected, make sure there is no gas leak. Use Dry Nitrogen to perform a gas leak detection.
- After knocking out the holes, we recommend you remove burrs in the knock holes and paint the edges and areas around the edges using the repair paint.

8.1. Caution for brazing

- Make sure to blow through with Dry Nitrogen when brazing. Blowing through with Dry Nitrogen prevents the creation of large quantities of oxidized film on the inside of the piping. An oxidized film adversely affects valves and compressors in the refrigerating system and prevents proper operation.
- The Dry Nitrogen pressure should be set to 2.9 psi (0.02 MPa (i.e., just enough so it can be felt on the skin)) with a pressure-reducing valve.

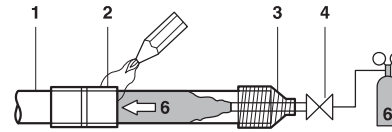

- 1 Refrigerant piping
- 2 Part to be brazed
- 3 Taping
- 4 Hands valve
- 5 Pressure-reducing valve
- 6 Dry Nitrogen

Do not use anti-oxidants when brazing the pipe joints. Residue can clog pipes and break equipment:

- Do not use flux when brazing copper-to-copper refrigerant piping. Use phosphor copper brazing filler alloy (BCuP) which does not require flux.
- Flux has an extremely harmful influence on refrigerant piping systems. For instance, if chlorine based flux is used, it will cause pipe corrosion or, in particular, if the flux contains fluorine, it will deteriorate the refrigerant oil.

8.2. Connecting the refrigerant piping

8.2.1. Decide front or side (bottom) connection

Installation of refrigerant piping is possible as front connection or side connection (when taken out from the bottom) as shown in the figure below.

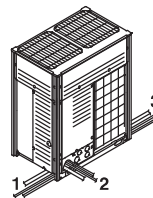

- 1 Left-side connection
- 2 Front connection
- 3 Right-side connection

- For side connections, the knockout hole on the bottom plate should be removed:

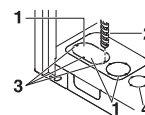

- 1 Knockout hole (Piping)
- 2 Drill
- 3 Points for drilling
- 4 Knockout hole (Power supply wiring)

NOTE

Precautions when knocking out knockout holes:

- Be sure to avoid damaging the casing.
- After knocking out the knockout holes, we recommend you remove the burrs and paint the edges and areas around the edges using repair paint to prevent rusting.
- When passing electrical wiring through the knock holes, protect the wiring with a conduit or bushings, making sure not to damage the wiring.

8.2.2. Remove the pinched pipes

WARNING

Any gas or oil remaining inside the stop valve may blow off the pinched piping.

Failure to observe the instructions in procedure below properly may result in property damage or personal injury, which may be serious depending on the circumstances.

Use the following procedure to remove the pinched piping:

- 1 Remove the valve cover and make sure that the stop valves are fully closed.

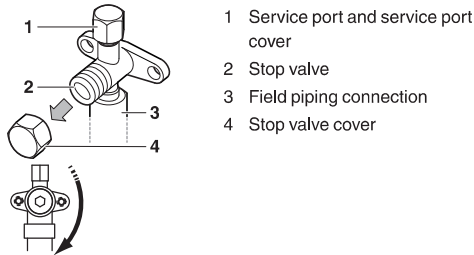

- 2 Connect the vacuuming/recovery unit to service ports of all stop valves.

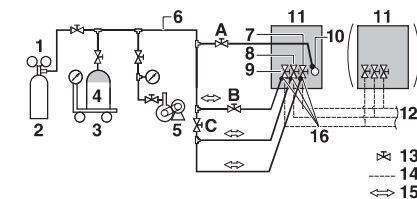

- 1 Gauge manifold
- 2 Nitrogen
- 3 Measuring instrument
- 4 Refrigerant R410A tank (siphon system)
- 5 Vacuum pump
- 6 Charge hose
- 7 High/low pressure gas pipe stop valve
- 8 Suction gas pipe stop valve
- 9 Liquid pipe stop valve
- 10 Refrigerant charge port
- 11 Outdoor unit
- 12 To Branch Selector unit (indoor unit)
- 13 Stop valve
- 14 Field piping
- 15 Gas flow
- 16 Stop valve service port
- A Valve A
- B Valve B
- C Valve C

- 3 Recover gas and oil from the pinched piping by using a recovery unit.

CAUTION

Do not vent gases into the atmosphere.

- 4 When all gas and oil is recovered from the pinched piping, disconnect the charge hose and close the service ports.

WARNING

When brazing at the proximity of the stop valves, be sure to protect the stop valves mounting plate with a protective plate to prevent from contacting with the burner flame.

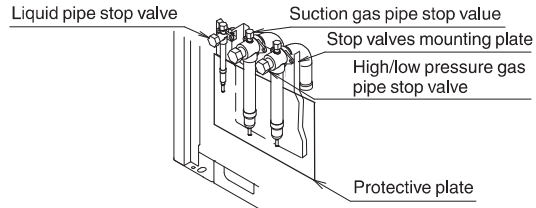

- 5 Cut off the lower part of the smaller pinched piping with an appropriate tool such as pipe cutters. Let the remaining oil drip out in case the recovery was not complete.

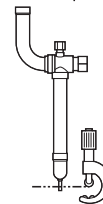

Wait until all oil is dripped out.

- 6 Cut the pinched piping off with a pipe cutter just above the brazing point or marking if there is no brazing point.

WARNING

Never remove the pinched piping by brazing. Any gas or oil remaining inside the stop valve may blow off the pinched piping. Failure to observe the instructions in procedure below properly may result in property damage or personal injury, which may be serious depending on the circumstances.

- 7 Wait until all oil is dripped out before continuing with the connection of the field piping in case the recovery was not complete.

8.2.3. Connecting refrigerant piping to the outdoor unit

- All pipings for gas and liquid over from the field connection piping kit are field supplied.

Front connection

Remove the knockout hole of the piping intake and connect piping to the piping intake.

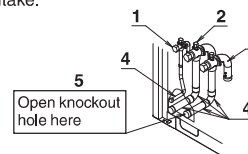

- 1 Liquid pipe stop valve
- 2 Suction gas pipe stop valve
- 3 High/low pressure gas pipe stop valve
- 4 Filed connection piping kit (accessory)
- 5 Knockout hole

Side (bottom) connection

Remove the knockout hole on the bottom frame and lead out the piping from the bottom frame.

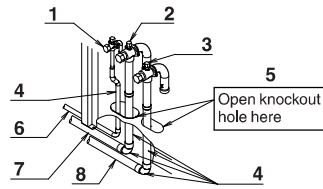

- 1 Liquid pipe stop valve
- 2 Suction gas pipe stop valve
- 3 High/low pressure gas pipe stop valve
- 4 Filed connection piping kit (accessory)
- 5 Knockout hole
- 6 Liquid side piping (field supply)
- 7 Suction gas side piping (field supply)
- 8 High/low pressure gas side piping (field supply)

INFORMATION

All local inter unit piping are field supplied except the accessory pipes.

NOTE

Precautions when connecting field piping. Add brazing material as shown in the figure.

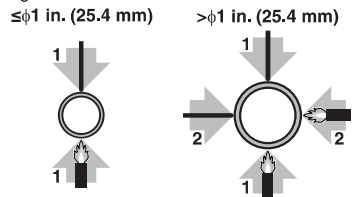

NOTE

- Be sure to use the supplied accessory pipes when carrying out piping work in the field.
- Be sure that the field installed piping does not touch other pipes, the bottom panel or side panel. Especially for the bottom and side connection, be sure to protect the piping with suitable insulation, to prevent it from coming into contact with the casing generated.

Connection from the stop valves to the field piping can be done by using accessory pipes supplied as accessory.

NOTE

Make sure that the onsite piping does not come in contact with other piping, the bottom frame or side panels of the unit.

The connections to the branch kits are the responsibility of the installer (field piping).

8.2.4. Precautions when connecting piping between outdoor units (multiple outdoor units system)

- To connect the piping between outdoor units, an optional multi connection piping kit BHFP26P100U/151U is always required. When installing the piping, follow the instructions in the installation manual that comes with the kit.

- Only proceed with piping work after considering the limitations on installing listed here and in the chapter 8.2. Connecting the refrigerant piping on page 14 always referring to the installation manual delivered with the kit.

8.2.5. Possible installation patterns and configurations

- The piping between the outdoor units must be routed level or slightly upward to avoid the risk of oil retention into the piping.

Pattern 1

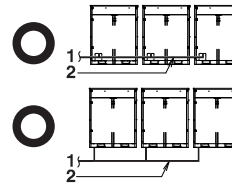

- 1 To indoor units
- 2 Piping between outdoor units

Pattern 2

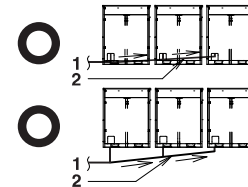

Prohibited patterns: change to pattern 1 or 2

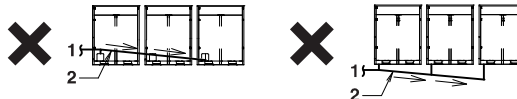

- 1 To indoor units
- 2 Piping between outdoor units

- To avoid the risk of oil retention to the outmost outdoor unit, always connect the stop valve and the piping between outdoor units as shown in the 4 correct possibilities of the figure below.

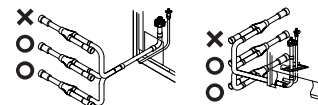

Prohibited patterns: change to pattern 1 or 2

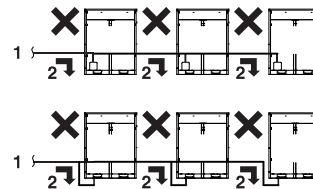

- 1 To indoor units
- 2 Oil collects to the outmost outdoor units

Change to configuration as in figure below

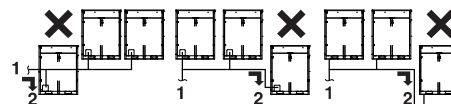

- 1 To indoor units
- 2 Oil collects to the outmost outdoor units

Correct configuration

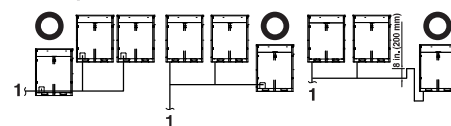

- 1 To indoor units

- If the piping length between the outdoor units exceeds 6.5 ft. (2 m), create a rise of 8 in. (200 mm) or more in the suction gas and high/low pressure gas line within a length of 6.5 ft. (2 m) from the kit.

If \leq 6.5 ft. (2 m)

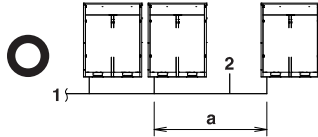

If $>$ 6.5 ft. (2 m)

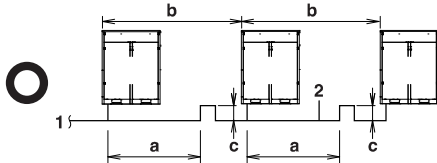

- 1 To indoor units
- 2 Piping between outdoor units
- a \leq 6.5 ft. (2 m)
- b \geq 8 in. (200 mm)
- c $>$ 6.5 ft. (2 m)

NOTE

There are restrictions on the refrigerant pipe connection order between outdoor units during installation in case of a multiple outdoor unit system. Install according to following restrictions. The capacities of outdoor units A, B and C must fulfill the following restriction conditions: $A \geq B \geq C$.

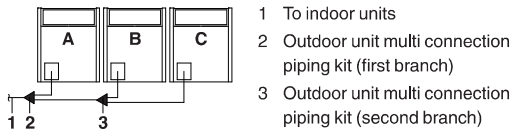

- 1 To indoor units
- 2 Outdoor unit multi connection piping kit (first branch)
- 3 Outdoor unit multi connection piping kit (second branch)

8.2.6. Branching the refrigerant piping

- 1 For installation of the refrigerant branch kit, refer to the installation manual delivered with the kit.

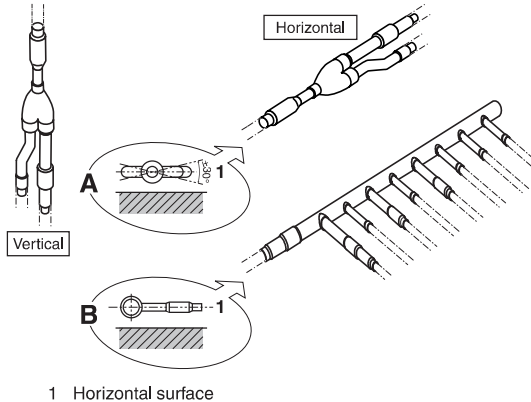

- Mount the REFNET joint so that it branches either horizontally or vertically.
- Mount the REFNET header so that it branches horizontally.

2 Installation of the multi connection piping kit.

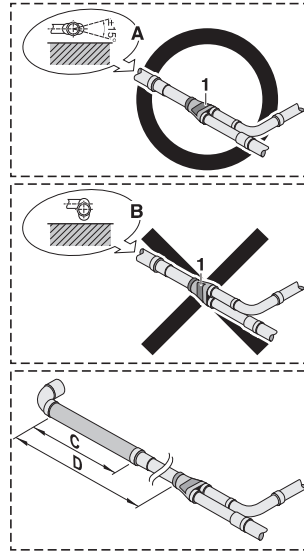

- C $>$ 4-3/4 in. (120 mm)
- D $>$ 19-11/16 in. (500 mm)

- Install the joints horizontally, so that the caution label (1) attached to the joint comes to the top.
 - Do not tilt the joint more than 15° (see view A).
 - Do not install the joint vertically (see view B).
- Make sure that the total length of the piping connected to the joint is absolute straight for more than 19-11/16 in. (500 mm). Only if a straight field piping of more than 4-3/4 in. (120 mm) is connected, more than 19-11/16 in. (500 mm) of straight section can be ensured.
- Improper installation may lead to malfunction of the outdoor unit.

8.3. Guidelines for handling stop valve

8.3.1. Cautions on handling the stop valve

- Make sure to keep all stop valves open during operation.
- The figure below shows the name of each part required in handling the stop valve.
- The stop valves are factory closed.
- When handle the stop valves, be careful not to damage the port pipes around (refer to P22).

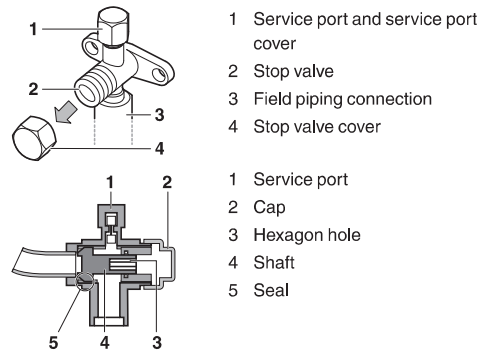

8.3.2. How to use the stop valve

Tightening torques

Stop valve size	Tightening torque (Turn clockwise to close)			Service port
	Shaft (valve body)		Cap (valve cover)	
φ3/8	3.98-4.87 ft·lbf (5.4-6.6 N·m)	Hexagonal wrench 4 mm	9.95-12.17 ft·lbf (13.5-16.5 N·m)	8.48-10.3 ft·lbf (11.5-13.9 N·m)
φ1/2	5.97-7.30 ft·lbf (8.1-9.9 N·m)		13.3-16.2 ft·lbf (18.0-22.0 N·m)	
φ3/4	19.9-24.3 ft·lbf (27.0-33.0 N·m)	Hexagonal wrench 8 mm	16.6-20.3 ft·lbf (22.5-27.5 N·m)	
φ1		Hexagonal wrench 10 mm		
φ1-1/8				

Opening the stop valve

- 1 Remove the stop valve cover.
- 2 Insert a hexagon wrench into the stop valve and turn the stop valve counterclockwise.
- 3 When the stop valve cannot be turned any further, stop turning. The valve is now open.
 - Turn the stop valve (φ3/8, φ1/2) until the shaft stops. (Opening the valve with excessive force may damage it.)
 - Turn the stop valve (φ3/4-φ1-1/8) until the shaft stops and the designated torque is achieved.
- 4 Tighten the stop valve cover securely by applying the designated torque.

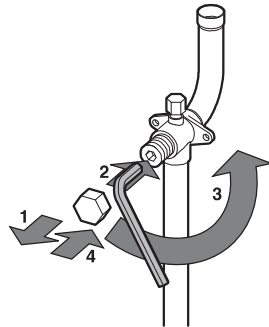

Closing the stop valve

- 1 Remove the stop valve cover.
- 2 Insert a hexagon wrench into the stop valve and turn the stop valve clockwise.
- 3 Turn until the shaft stops by applying the designated torque. The valve is now closed.
- 4 Tighten the stop valve cover securely by applying the designated torque.

Closing direction

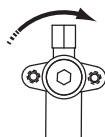

8.3.3. Cautions on handling the stop valve cover

- The stop valve cover is sealed where indicated by the arrow. Take care not to damage it.

- After handling the stop valve, make sure to tighten the stop valve cover securely. For the tightening torque, refer to 8.3.2. How to use the stop valve.
- Check for refrigerant leaks after tightening the stop valve cover.

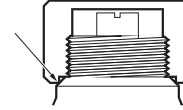

8.3.4. Cautions on handling the service port

- Always use a charge hose equipped with a valve depressor pin, since the service port is a Schrader type valve.
- After handling the service port, make sure to tighten the service port cover securely. For the tightening torque, refer to 8.3.2. How to use the stop valve.
- Check for refrigerant leaks after tightening the service port cover.

9. Field wiring

NOTE

- All field wiring and components must be installed by a licensed electrician and must comply with relevant local and national regulations.
- Be sure to use a dedicated power circuit. Never use a power supply shared by another appliance.
- Never install a phase-advancing capacitor. As this unit is equipped with an inverter, installing a phase-advancing capacitor will not only deteriorate power factor improvement effect, but also may cause capacitor abnormal heating accident due to high-frequency waves.
- Only proceed with wiring work after blocking off all power.
- Always ground wires in accordance with relevant local and national regulations.
- This machine includes an inverter device. Connect ground and leave charge to eliminate the impact on other devices by reducing noise generated from the inverter device and to prevent leaked current from being charged in the outer shell of the product.
- Do not connect the ground wire to gas pipes, sewage pipes, lightning rods, or telephone ground wires.
 - Gas pipes** can explode or catch fire if there is a gas leak.
 - Sewage pipes:** no grounding effect is possible if hard plastic piping is used.
 - Telephone ground wires and lightning rods** are dangerous when struck by lightning due to abnormal rise in electrical potential in the grounding.
- This equipment can be installed with a Ground-Fault Circuit Interrupter (GFCI). Although this is a recognized measure for additional protection, with the grounding system in North America, a dedicated GFCI is not necessary.
- Electrical wiring must be done in accordance with the wiring diagrams and the description herein.
- Do not operate until refrigerant piping work is completed. Operating the unit before completing piping work could cause the compressor to break.
- Never remove a thermistor, sensor or similar parts when connecting power wiring and transmission wiring. (If operated with a thermistor, sensor or similar parts removed, the compressor may be broken down.)
- Never connect the power supply in reverse-phase. The unit cannot operate normally in reverse-phase. If you connect in reverse-phase, replace 2 of the 3 phases.
- Make sure the electrical imbalance ratio is no greater than 2%. If it is larger than this, the unit's lifespan will be reduced. If the ratio exceeds 4%, the unit will shut down and an malfunction code will be displayed on the indoor remote controller.

- Connect the wire securely using designated wire and fix it with attached clamp without applying external pressure on the terminal parts (terminal for power wiring, terminal for transmission wiring and ground terminal).
- If there exists the possibility of reverse-phase, lose phase, momentary blackout or the power goes on and off while the product is operating, attach a reverse-phase protection circuit locally. Running the product in reverse-phase may break the compressor and other parts.

9.1. Power circuit, safety device and cable requirements

- A power circuit (see the following table) must be provided for connection of the unit. This circuit must be protected with the required safety devices, i.e. a main switch, a slow blow fuse on each phase.
- When using residual current operated circuit breakers, be sure to use a high-speed type (0.1 seconds or less) 200 mA rated residual operating current.
- Use copper conductors only.
- Use insulated wire for the power cord.
- Select the power supply cable type and size in accordance with relevant local and national regulations.

REYQ	Phase and frequency	Voltage	Minimum circuit amp.	Maximum overcurrent protective device	Transmission line selection
72TTJU	φ3, 60Hz	208/230V	30.2A	35A	AWG18-16
96TTJU	φ3, 60Hz	208/230V	38.0A	45A	AWG18-16
120TTJU	φ3, 60Hz	208/230V	43.0A	50A	AWG18-16
144TTJU	φ3, 60Hz	208/230V	55.0A	70A	AWG18-16
168TTJU	φ3, 60Hz	208/230V	61.9A	70A	AWG18-16
192TTJU	φ3, 60Hz	208/230V	30.2A+43.0A	35A+50A	AWG18-16
216TTJU	φ3, 60Hz	208/230V	38.0A+43.0A	45A+50A	AWG18-16
240TTJU	φ3, 60Hz	208/230V	38.0A+55.0A	45A+70A	AWG18-16
264TTJU	φ3, 60Hz	208/230V	43.0A+55.0A	50A+70A	AWG18-16
288TTJU	φ3, 60Hz	208/230V	55.0A+55.0A	70A+70A	AWG18-16
312TTJU	φ3, 60Hz	208/230V	55.0A+61.9A	70A+70A	AWG18-16
336TTJU	φ3, 60Hz	208/230V	61.9A+61.9A	70A+70A	AWG18-16
360TTJU	φ3, 60Hz	208/230V	43.0A+43.0A+43.0A	50A+50A+50A	AWG18-16
384TTJU	φ3, 60Hz	208/230V	38.0A+43.0A+61.9A	45A+50A+70A	AWG18-16
408TTJU	φ3, 60Hz	208/230V	38.0A+55.0A+61.9A	45A+70A+70A	AWG18-16
432TTJU	φ3, 60Hz	208/230V	55.0A+55.0A+55.0A	70A+70A+70A	AWG18-16
456TTJU	φ3, 60Hz	208/230V	55.0A+55.0A+61.9A	70A+70A+70A	AWG18-16
72TYDN	φ3, 60Hz	460V	15.2A	20A	AWG18-16
96TYDN	φ3, 60Hz	460V	21.1A	25A	AWG18-16
120TYDN	φ3, 60Hz	460V	21.1A	25A	AWG18-16
144TYDN	φ3, 60Hz	460V	31.9A	40A	AWG18-16
168TYDN	φ3, 60Hz	460V	36.1A	40A	AWG18-16
192TYDN	φ3, 60Hz	460V	15.2A+21.1A	20A+25A	AWG18-16
216TYDN	φ3, 60Hz	460V	21.1A+21.1A	25A+25A	AWG18-16
240TYDN	φ3, 60Hz	460V	21.1A+31.9A	25A+40A	AWG18-16
264TYDN	φ3, 60Hz	460V	21.1A+31.9A	25A+40A	AWG18-16
288TYDN	φ3, 60Hz	460V	31.9A+31.9A	40A+40A	AWG18-16
312TYDN	φ3, 60Hz	460V	31.9A+36.1A	40A+40A	AWG18-16
336TYDN	φ3, 60Hz	460V	36.1A+36.1A	40A+40A	AWG18-16
360TYDN	φ3, 60Hz	460V	21.1A+21.1A+21.1A	25A+25A+25A	AWG18-16
384TYDN	φ3, 60Hz	460V	21.1A+21.1A+36.1A	25A+25A+40A	AWG18-16
408TYDN	φ3, 60Hz	460V	21.1A+31.9A+36.1A	25A+40A+40A	AWG18-16
432TYDN	φ3, 60Hz	460V	31.9A+31.9A+31.9A	40A+40A+40A	AWG18-16
456TYDN	φ3, 60Hz	460V	31.9A+31.9A+36.1A	40A+40A+40A	AWG18-16

9.2. Wiring connection example for whole system

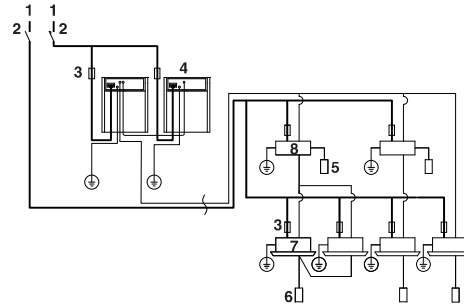

- 1 Power supply
- 2 Main switch
- 3 Fuse or circuit breaker
- 4 Outdoor unit
- 5 COOL/HEAT selector
- 6 Remote controller
- 7 Indoor unit
- 8 Branch Selector unit

This image is intended as an example only. Please follow local and national electrical code.

NOTE

- Make sure the low voltage wiring (i.e. for the remote controller, between units) and the power wiring do not pass near each other, keeping them at least 2 in. (51 mm) apart. Proximity may cause electrical interference, malfunctions, and breakage.
- Be sure to connect the power wiring to the power wiring terminal block and secure it as described in 9.5. Power wiring connection procedure.
- Transmission wiring should be secured as described in 9.4. Transmission wiring connection procedure.
- Secure wiring with clamp such as insulation lock ties to avoid contact with piping.
- Shape the wires to prevent the structure such as the control box cover deforming. And close the cover firmly.
- All field wiring is to be procured on site.

9.3. Leading wire procedure

- The power wiring and ground wiring are passed out from the power wiring hole on the front (knock hole).
- The transmission wiring is passed out from the wiring hole (knock hole) on the front of the unit.

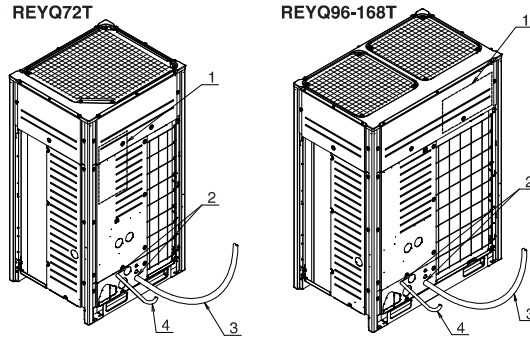

- 1 Wiring diagram printed on the back of the control box cover.
- 2 Knockout hole
- 3 Power line
- 4 Transmission line

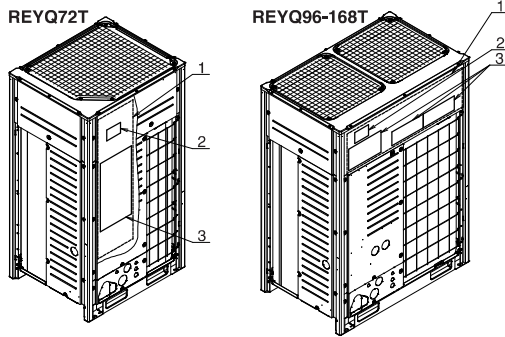

- 1 Control box cover
- 2 Inspection door
- 3 [Service precautions] Label location

NOTE

- Open the knock holes with a hammer or similar tool.
- After knocking out the holes, we recommend you remove any burrs and paint the holes with repair paint to prevent rusting. (Refer to the above figures.)
- When passing wiring through the knock holes, remove burrs around the knock holes and protect the wiring with protective tape. (Refer to the above figures.)
- If small animals might enter the unit, block off any gaps (hatching parts in the above figures) with material (field supply).

9.4. Transmission wiring connection procedure

- Referring to the figure below, connect the transmission wiring between outdoor unit and indoor unit, outdoor unit and outdoor unit of other system, outdoor unit and outdoor unit of same system.

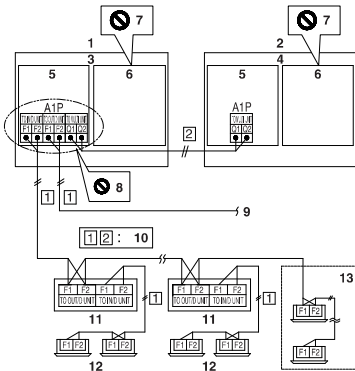

- 1 Master unit (*)
- 2 Sub unit (*)
- 3 Outdoor unit A
- 4 Outdoor unit B
- 5 Control box (1)
- 6 (Only REYQ-TYDN)
Control box (2)
- 7 (Only REYQ-TYDN)
Do not open the control box (2) cover.
(There are no work when installation.)
- 8 Never connect the power wire.
- 9 To outdoor unit of other system
- 10 Use duplex wires (No polarity)

- 11 Branch Selector unit
- 12 Indoor unit
- 13 Indoor unit (Cooling only)

(*) : The outdoor unit that connect the transmission wiring to Branch Selector unit is Master unit of the multi system. And the other units are Sub unit. (In this figure, outdoor unit A is the Master unit.)
Check operation in installation work, onsite settings and so on are done by operating the printed circuit board (A1P) of Master unit.

NOTE

- Do not connect the power wiring to terminals for the transmission wiring. Doing so would destroy the entire system.
 - When connecting wires to the terminal block on the printed circuit board, too much heat or tightening could damage the printed circuit board. Attach with care.
- See the table below for the tightening torque of the transmission wiring terminals.

Screw size	Tightening torque
M3.5 (A1P)	0.59-0.71 ft·lbf (0.8-0.97 N·m)

- Transmission wiring (about the symbol 1-2, see the foregoing figure) should be done within the following limitations. If they are exceeded, transmission problems may occur.

- 1 Between outdoor unit and Branch Selector (indoor) unit
Between outdoor unit and outdoor unit of other systems
Max. wiring length : 3280 ft. (1000 m)
Max. total wiring length : 6560 ft. (2000 m)
Max. no. of branches : 16

[Note] No branch is allowed after a branch. See the following figure.

Max. no. of outdoor units of other system that can be connected : 10

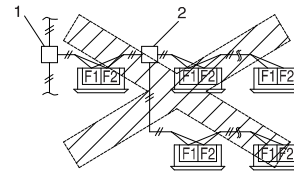

- 1 Branch
- 2 Branch after branch
- 2 Between outdoor unit and outdoor unit of same system
Max. wiring length : 98 ft. (30 m)

- The transmission wiring inside the control box should be secured using the clamp (1) as shown in the figure below.

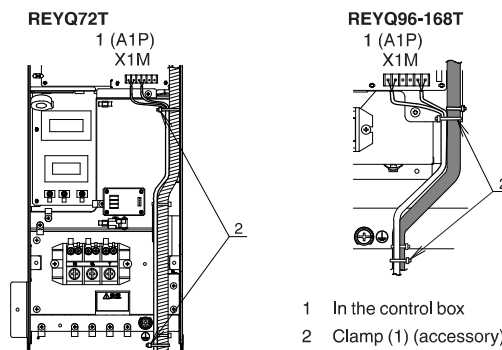

- Outside the units, the transmission wiring must be finished simultaneously with the local refrigerant piping, and wound with tape (field supply) as shown in the figure below.

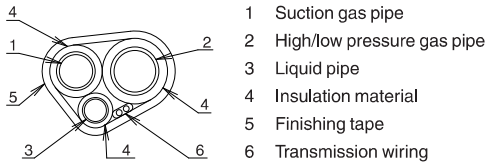

- For multi system:
 - Transmission wiring between outdoor units in the same piping system must be connected to terminals Q1 and Q2 (TO MULTI UNIT). Connecting the wires to the F1, F2 (TO OUT/D UNIT) terminals results in system malfunction.
 - Wiring to other systems should be connected to terminals F1 and F2 (TO OUT/D UNIT) on the printed circuit board of the master unit. The outdoor unit that connects transmission wiring to indoor unit is the master unit. The others are sub unit.

- Power supply (MODEL TYDN: 3 ~ 460 V 60 Hz) (MODEL TTJU: 3 ~ 208/230 V 60 Hz)
- Branch switch, Overcurrent breaker
- Ground wire
- Control box
- (Only REYQ-TYDN) Control box (2)
- (Only REYQ-TYDN) Do not open the control box (2) cover. (There are no work when installation.)
- Attach insulation sleeves
- Power supply terminal block
- Ground terminal
- Clamp (1) (accessory)
- Vinyl tube (accessory)

CAUTION

- Be sure to use crimp-style terminal with insulating sleeves for connections. (See the figure below.)

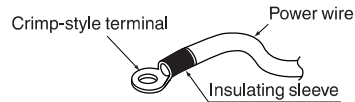

9.5. Power wiring connection procedure

- Be sure to connect the power supply wiring to the power supply terminal block and hold it in place using the included clamp as shown in the figure below.
- The L1, L2 and L3 phases of the power wiring should be secured separately to the hook using the included clamp (1).
- The ground wiring should be bound to the power wiring using the included clamp (1) to prevent outside force from being applied to the terminal area.

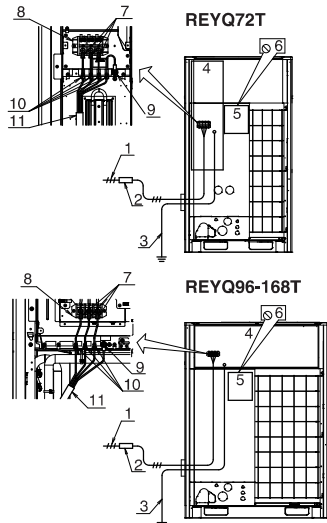

- For wiring, use the designated power wire and connect firmly, then secure to prevent outside pressure being exerted on the terminal board.
- Use an appropriate screwdriver for tightening the terminal screws. A screwdriver with a small head will strip the head and make proper tightening impossible.
- Over-tightening the terminal screws may break them. See the following table for the tightening torque of the terminal screws.

Screw size	Tightening torque
M8 Power terminal	4.20-5.09 ft-lbf (5.7-6.9 N-m)
M8 Ground terminal	7.15-8.63 ft-lbf (9.7-8.63 N-m)

- When pulling the ground wire out, wire it so that it comes through the cut out section of the cup washer. (See the figure below.) An improper ground connection may prevent a good ground from being achieved.

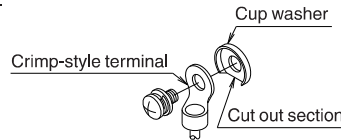

- When 2 wires are connected to a single terminal, connect them so that the rear sides of the crimp contacts face each other. Also, make sure the thinner wire is on top, securing the 2 wires simultaneously to the resin hook using the included clamp (1).

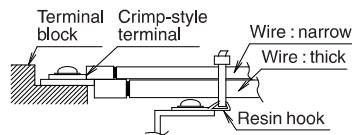

9.6. Procedure for Wiring Inside Units

- Referring to the figure below, secure and wire the power and transmission wiring using the included clamp (1), (2) and (3).
- Wire so that the ground wiring does not come into contact with the compressor lead wiring.
If they touch, this may have an adverse effect on other devices.
- The transmission wiring must be at least 2 in. (51 mm) away from the power wiring.
- Route wiring so that it does not come into contact with the high-temperature pipes (indicated by the hatching in the figure below) or the port pipes (see figure below).

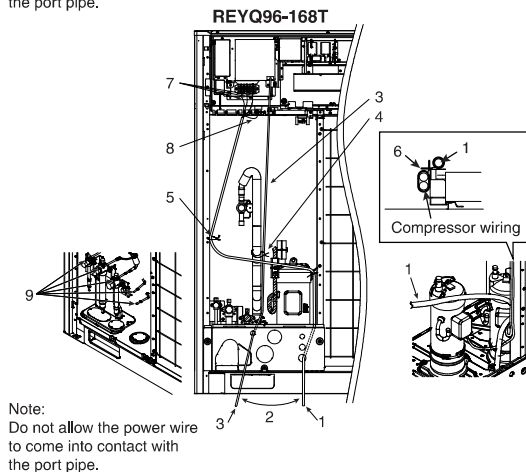
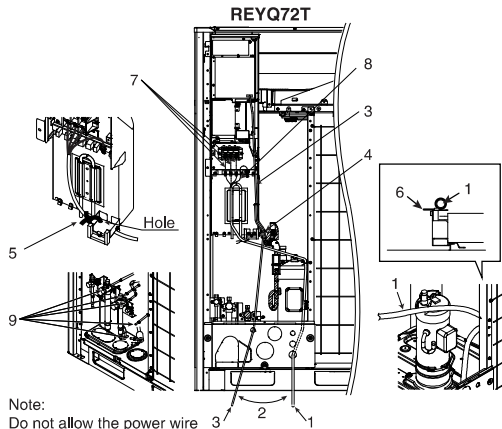

- | | |
|----------------------------|-------------------------|
| 1 Power/ground wires | 6 Clamp (3) (accessory) |
| 2 Clear over 2 in. (50 mm) | 7 Power wiring |
| 3 Transmission wiring | 8 Ground wire |
| 4 Clamp (1) (accessory) | 9 Port pipes |
| 5 Clamp (2) (accessory) | |

NOTE
Do not touch the port pipes during wiring work. Damages of pipes may cause refrigerant leak.

Precautions when knocking out knockout holes

- To punch out a knockout hole, hit it with a hammer.
- Open an appropriate hole as needed.
- After knocking out the holes, trim off the burr, then we recommend you to paint the edges and areas around the edges using the repair paint to prevent rusting.
- Power line: Open a knockout hole as shown at right and connect it using a conduit.
Choose an appropriate knockout hole for conduit size suitable for the power and ground line to be used.
- Transmission line: Connect it using a conduit in the knockout hole on the left.

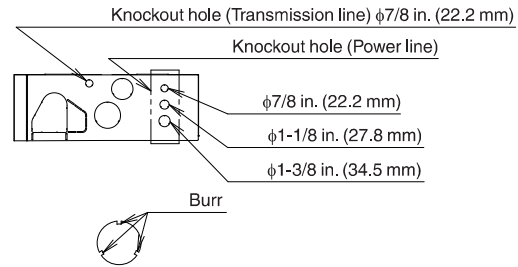

NOTE
After wiring work is completed, check to make sure there are no loose connections among the electrical parts in the control box.

10. Air tight test and vacuum drying

- After finished piping work, carry out air tight test and vacuum drying.
- NOTE**
- Always use nitrogen gas for the air tightness test.
 - Absolutely do not open the stop valve until the main power circuit insulation measurement has been completed. (Measuring after the stop valve is opened will cause the insulation value to drop.)

<Needed tools>

Gauge manifold Charge hose valve	<ul style="list-style-type: none"> • To prevent entry of any impurities and insure sufficient pressure resistance, always use the special tools dedicated for R410A. • Use charge hose that have pushing stick for connecting to service port of stop valves or refrigerant charge port.
Vacuum pump	<ul style="list-style-type: none"> • The vacuum pump for vacuum drying should be able to lower the pressure to 500 microns. • Take care the pump oil never flow backward into the refrigerant pipe during the pump stops.

<The system for airtight test and vacuum drying>

- Referring to the figure below, connect a nitrogen tank, refrigerant tank, and a vacuum pump to the outdoor unit.
The refrigerant tank and the charge hose connection to refrigerant charge port or the valve A in the figure below are needed in 14. Charging refrigerant on page 26.

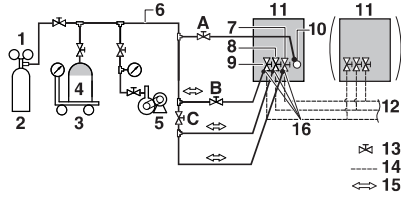

- 1 Gauge manifold
- 2 Nitrogen
- 3 Measuring instrument
- 4 Refrigerant R410A tank (siphon system)
- 5 Vacuum pump
- 6 Charge hose
- 7 High/low pressure gas pipe stop valve
- 8 Suction gas pipe stop valve
- 9 Liquid pipe stop valve
- 10 Refrigerant charge port
- 11 Outdoor unit
- 12 To Branch Selector unit (indoor unit)
- 13 Stop valve
- 14 Field piping
- 15 Gas flow
- 16 Stop valve service port
- A Valve A
- B Valve B
- C Valve C

NOTE

- The air-tightness test and vacuum drying should be done using the service ports of suction gas pipe, high/low pressure gas pipe and liquid pipe stop valve. See the [R410A] Label attached to the front panel of the outdoor unit for details on the location of the service port (see the figure below).

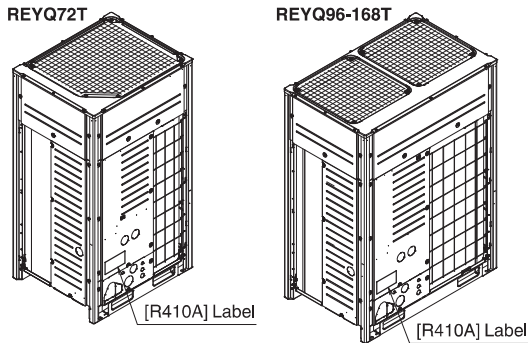

- See 14.3. Method for adding refrigerant on page 28 for details on handling the stop valve.
- The refrigerant charge port is connected to unit pipe. When shipped, the unit contains the refrigerant, so use caution when attaching the charge hose.

<Air tight test>

Pressurize the suction gas pipe, high/low pressure gas pipe and liquid pipe from the service ports of each stop valve to 550 psi (3.8 MPa) (do not pressurize more than 550 psi (3.8 MPa)). If the pressure does not drop within 24 hours, the system passes the test.

If there is a pressure drop, check for leaks, make repairs and perform the air tight test again.

<Vacuum drying>

Evacuate the system from the suction gas pipe, high/low pressure gas pipe and liquid pipe stop valve service ports by using a vacuum pump for more than 2 hours and bring the system to 500 microns or less. After keeping the system under that condition for more than 1 hour, check if the vacuum gauge rises or not. If it rises, the system may either contain moisture inside or have leaks.

NOTE

During the rainy season, moisture might enter the piping. If working during a rainy season and the work takes long enough for condensation to form inside the pipes, take the following precautions:

After evacuating the system for 2 hours, pressurize the system to 7.25 psi (0.05 MPa) (vacuum break) with nitrogen gas and evacuate the system again using the vacuum pump for 1 hour to 500 microns or less (vacuum drying).
If the system cannot be evacuated to 500 microns within 2 hours, repeat the operation of vacuum break and vacuum drying.
Then, after leaving the system in a vacuum for 1 hour, confirm that the vacuum gauge does not rise.

11. Pipe insulation

- Insulation of pipes should be done after performing 10. Air tight test and vacuum drying on page 22.
- Always insulate the suction gas pipe, high/low pressure gas pipe, liquid pipe and pipe connections.
- Failing to insulate the pipes may cause leaking or burns. Be sure to use insulation designed for HVAC equipment.
- Reinforce the insulation on the refrigerant piping according to the installation environment. Condensation might form on the surface of the insulation. Refer to the below.
 - Ambient temperature : 86°F (30°C), humidity : 75% to 80% RH : minimum thickness : 9/16 in. (15 mm).
 - If the ambient temperature exceeds 86°F (30°C) and the humidity 80% RH, then the minimum thickness is 3/4 in. (20 mm). See the Engineering Data Book for detail.
- If there is a possibility that condensation on the stop valve might drip down into the indoor unit through gaps in the insulation and piping because the outdoor unit is located higher than the indoor unit, this must be prevented by caulking the connections. (Refer to the following figure.)

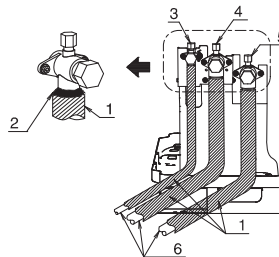

- 1 Insulation material
- 2 Caulking, etc.
- 3 Liquid pipe stop valve
- 4 Suction gas pipe stop valve
- 5 High/low pressure gas pipe stop valve
- 6 Connection pipe

12. Checking of device and installation conditions

Be sure to check the followings.

For those doing electrical work

- 1 Make sure there is no faulty transmission wiring or loosening of a nut.
See 9.4. Transmission wiring connection procedure on page 20.
- 2 Make sure there is no faulty power wiring or loosening of a nut.
See 9.5. Power wiring connection procedure on page 21.
- 3 Has the insulation of the main power circuit deteriorated?
Measure the insulation and check the insulation is above regular value in accordance with relevant local and national regulations.

For those doing pipe work

- 1 Make sure piping size is correct.
See 7.2. Selection of piping material on page 9 and 7.4. Selection of refrigerant branch kits on page 10.
- 2 Make sure insulation work is done.
See 11. Pipe insulation.
- 3 Make sure there is no faulty refrigerant piping.
See 8. Precautions on refrigerant piping on page 14.

13. Making field settings

To continue the configuration of the outdoor units, it is required to give some input to the printed circuit board of the unit. This chapter will describe how manual input is possible by operating the push buttons/DIP switches on the printed circuit board and reading the feedback from the 7 segment displays.

For VRV IV REYQ-T series it is alternatively possible to make several commissioning field settings through a personal computer interface (for this, option EKPCAB* is required). The installer can prepare the configuration (off-site) on PC and afterwards upload the configuration to the system. How to connect the cable is described in 13.3. Connecting the PC configurator to the outdoor unit on page 26.

The contents of the actual settings is discussed and explained in 15.2. Monitoring function and field settings on page 33.

13.1. Accessing the push buttons on the printed circuit board

It is not required to open the complete control box to access the push buttons on the printed circuit board and read out the 7 segment display (s).

To access you can remove the front panel (see figure). Now you can open the inspection door of the control box cover (see figure). You can see 3 push buttons and 3 seven-segment displays and DIP switches.

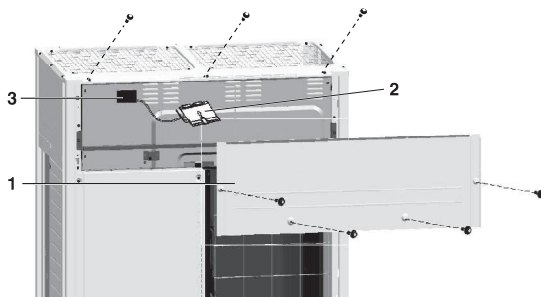

- 1 Front panel
- 2 Inspection door
- 3 Main printed circuit board with 3 seven-segment display and 3 push buttons

Operate the switches and push buttons with an insulated stick (such as a closed ballpoint pen) to avoid touching of live parts.



Location of the segment displays, buttons and DIP switches:

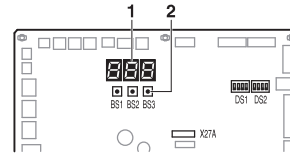

- BS1 for changing setting mode
- BS2, BS3 for changing field setting
- DS1, DS2 DIP switches
- 1 7 segment displays (3×)
- 2 Push buttons

Segment display indications:

- Off
- Blinking
- On

13.2. Operating the push buttons and DIP switches on the printed circuit board

13.2.1. Operating the push buttons

By operating the push buttons it is possible to:

- Perform special actions (automatic refrigerant charging, test run, etc).
- Perform field settings (demand operation, low noise, etc).

Below procedure explains how to operate the push buttons to reach the required mode in the menu, select the correct setting and modify the value of the setting. This procedure can be used any time special settings and regular field setting are discussed in this manual (see 15.2. Monitoring function and field settings on page 33).

Setting definition: [A-B]=C; A=mode; B=setting; C=setting value. A, B and C are numerical values for field settings. Parameter C has to be defined. It can be a chosen from a set (0, 1, 2, 3, 4, 5, ...) or regarded as an ON/OFF (1 or 0) depending on the contents. This is informed when the field setting is explained (see 15.2. Monitoring function and field settings on page 33).

INFORMATION

During special operation (e.g., automatic refrigerant charging, test run, etc.) or when an malfunction happened, information will contain letters and numerical values.

Functions of the push button switches which are located on the main printed circuit board (A1P)

Turn on the power supply of the outdoor unit and all indoor units. When the communication between indoor units and outdoor unit (s) is established and normal, the segment indication state will be as follows (default situation when shipped from factory):

When turning on the power supply, the display flashes on and off. First checks of the power supply are executed (1-2 minutes).



When no trouble occurs: lighted as indicated (8-10 minutes).



Ready for operation: blank display indication as indicated.

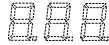

When above situation cannot be confirmed after 12 minutes, the malfunction code can be checked on the indoor unit user interface and the outdoor unit segment display. Solve the malfunction code accordingly. The communication wiring should be checked at first.

Information

Be sure to turn the power on at least 6 hours before operation in order to have power running to the crank case heater.

Accessing modes

BS1 is used to change the mode you want to access.

- Access mode 1

Push BS1 one time. Segment indication changes to:



- Access mode 2

Push BS1 for at least 5 seconds. Segment indication changes to:



Information

If you get confused in the middle of the process, push BS1. Then it returns to idle situation (no indication on segment displays: blank, refer to Functions of the push button switches which are located on the main printed circuit board (A1P) on page 24).

Mode 1

Mode 1 is used to set basic settings and to monitor the status of the unit (15.2. Monitoring function and field settings on page 33).

- Changing and access the setting in mode 1: Once mode 1 is selected (push BS1 one time), you can select the wanted setting. It is done by pushing BS2. Accessing the selected setting's value is done by pushing BS3 one time.
- To quit and return to the initial status, press BS1.

Example:

Checking the content of parameter [1-10] (to know how many indoor units are connected to the system).

[A-B]=C in this case defined as: A=1; B=10; C=the value we want to know/monitor:

- Make sure the segment indication is displayed in operational default mode as shipped from factory.
- Push BS1 one time; result segment display:



Result: mode 1 is accessed.

- Push BS2 10 times; result segment display:



Result: mode 1 setting 10 is addressed.

- Push BS3 one time; the value which is returned (depending on the actual field situation), is the amount of indoor units which are connected to the system. Result: mode 1 setting 10 is addressed and selected, return value is monitored information.
- To leave the monitoring function, push BS1 one time, you will return to the default situation when shipped from factory.

Mode 2

Mode 2 is used to set field settings of the outdoor unit and system.

- Changing and access the setting in mode 2: Once mode 2 is selected (push BS1 for more than 5 seconds), you can select the wanted setting. It is done by pushing BS2. Accessing the selected setting's value is done by pushing BS3 one time.
- To quit and return to the initial status, press BS1.
- Changing the value of the selected setting in mode 2:
 - Once mode 2 is selected (push BS1 for more than 5 seconds) you can select the wanted setting. It is done by pushing BS2.
 - Accessing the selected setting's value is done by pushing BS3 one time.
 - Now BS2 is used to select the required value of the selected setting.
 - When the required value is selected, you can define the change of value by pushing BS3 one time.
 - Press BS3 again to start operation according to the chosen value.

Example:

Checking the content of parameter [2-18] (to define the high static pressure setting of the outdoor unit's fan).

[A-B]=C in this case defined as: A=2; B=10; C=the value we want to know/change

Make sure the segment indication is as during normal operation (default situation when shipped from factory).

- Push BS1 for over 5 seconds; result segment display:



Result: mode 2 is accessed.

- Push BS2 18 times; result segment display:



Result: mode 2 setting 18 is addressed.

- Push BS3 one time; the value which is returned (depending on the actual field situation), is the status of the setting. In the case of [2-18], default value is 0, which means the function is not active. Result: mode 2 setting 18 is addressed and selected, return value is the current setting situation.
- To change the value of the setting, push BS2 till the required value appears on the segment indication. When achieved, define the setting value by pushing BS3 one time. To start operation according to the chosen setting, confirm again by pushing BS3.
- To leave the monitoring function, push BS1 two times, you will return to the default situation when shipped from factory.

13.2.2. Operating the DIP switches

By operating the DIP switches it is possible to:

What to do with DIP switch DS1	
1	Cool/Heat selector (refer to the manual of the Cool/Heat selector switch) OFF=not installed=factor setting
2-4	NOT USED DO NOT CHANGE THE FACTORY SETTING
What to do with DIP switch DS2	
1-4	NOT USED DO NOT CHANGE THE FACTORY SETTING

13.3. Connecting the PC configurator to the outdoor unit

Connection of the optional PC configurator cable to the outdoor unit has to be done on A1P. Connect the EKPCAB* cable to the 5-pin blue connector X27A.

CAUTION
Works executed on the outdoor unit are best done under dry weather conditions to avoid water ingress.

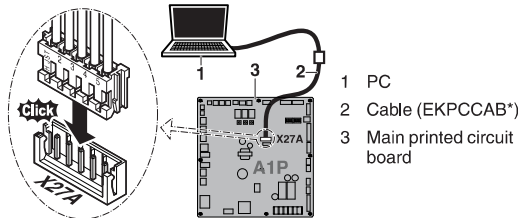

14. Charging refrigerant

14.1. Precautions

- NOTE**
- Refrigerant cannot be charged until field wiring has been completed.
 - Refrigerant may only be charged after performing the leak test and the vacuum drying.
 - When charging a system, care shall be taken that its maximum permissible charge is never exceeded, in view of the danger of liquid hammer.
 - Charging with an unsuitable substance may cause explosions and accidents, so always ensure that the appropriate refrigerant R410A is charged.
 - Refrigerant containers shall be opened slowly.
 - Always use protective gloves and protect your eyes when charging refrigerant.
 - When the refrigerant system is to be opened, refrigerant must be treated according to the applicable legislation.

DANGER
See Safety considerations on page i.

- To avoid compressor breakdown. Do not charge the refrigerant more than the specified amount.
- This outdoor unit is factory charged with refrigerant and depending on pipe sizes and pipe lengths some systems require additional charging of refrigerant. See 14.2. Calculating the additional refrigerant charge.
- In case recharge is required, refer to the nameplate of the unit. It states the type of refrigerant and necessary amount.

14.2. Calculating the additional refrigerant charge

NOTE
The refrigerant charge of the system must be less than 210 lbs. (100 kg). This means that in case the calculated total refrigerant charge is equal to or more than 209 lbs. (95 kg) you must divide your multiple outdoor system into smaller independent systems, each containing less than 209 lbs. (95 kg) refrigerant charge. For factory charge, refer to the unit nameplate.

14.2.1. How to calculate the additional refrigerant to be charged

Additional refrigerant to be charged=R (lbs.). R should be rounded off in units of 0.1 lbs.

$$R=[(X1 \times \phi 7/8) \times 0.249+(X2 \times \phi 3/4) \times 0.175+(X3 \times \phi 5/8) \times 0.121+(X4 \times \phi 1/2) \times 0.081+(X5 \times \phi 3/8) \times 0.040+(X6 \times \phi 1/4) \times 0.015] \times 1.04+[A]+[B]+[C]$$

X1...6 =Total length (ft. (m)) of liquid piping size at ϕa

* In units of 0.1 kg, additional refrigerant to be charged=R (kg).

$$R=[(X1 \times \phi 22.2) \times 0.37+(X2 \times \phi 19.1) \times 0.26+(X3 \times \phi 15.9) \times 0.18+(X4 \times \phi 12.7) \times 0.12+(X5 \times \phi 9.5) \times 0.059+(X6 \times \phi 6.4) \times 0.022] \times 1.04+[A]+[B]+[C]$$

Parameter [A] Refrigerant amount for Branch Selector units	
Branch Selector unit model	Refrigerant amount
BS4Q54T	0.7 lbs./unit (0.3 kg/unit)
BS6Q54T	0.9 lbs./unit (0.4 kg/unit)
BS8Q54T	1.1 lbs./unit (0.5 kg/unit)
BS10Q54T	1.5 lbs./unit (0.7 kg/unit)
BS12Q54T	1.8 lbs./unit (0.8 kg/unit)
BSQ36T	0.1 lbs./unit (0.05 kg/unit)
BSQ60T	0.2 lbs./unit (0.1 kg/unit)
BSQ96T	0.4 lbs./unit (0.2 kg/unit)

Parameter [B] Refrigerant amount for outdoor units	
Outdoor unit capacity type	Refrigerant amount
REYQ72T	0.0 lbs./unit (0.0 kg/unit)
REYQ96T	3.1 lbs./unit (1.4 kg/unit)
REYQ120T	3.3 lbs./unit (1.5 kg/unit)
REYQ144T	10.6 lbs./unit (4.8 kg/unit)
REYQ168T	10.8 lbs./unit (4.9 kg/unit)

Parameter [C] Refrigerant amount by field piping length and indoor units capacity				
Field piping length	Total indoor unit capacity connection ratio	Refrigerant amount		
		Total outdoor unit capacity type		
		REYQ72-144T	REYQ168-288T	REYQ312-456T
< 295.3 ft. (90 m)	≤ 85%	0.0		
	> 85%	The smaller of [D] or 5.51 lbs. (2.5 kg)	The smaller of [D] or 6.61 lbs. (3.0 kg)	The smaller of [D] or 7.50 lbs. (3.4 kg)
≥ 295.3 ft. (90 m)	≤ 85%	0.0		
	> 85%	2.20 lbs. (1.0 kg)		

Parameter [D]										
Indoor unit capacity type	FXMQ type									
	07	09	12	15	18	24	30	36	48	54
Refrigerant amount (lbs. (kg)/unit)	0.06 (0.03)	0.03 (0.014)	0.14 (0.06)	0.29 (0.13)	0.25 (0.11)	0.16 (0.07)	0.33 (0.15)	0.25 (0.11)	0.08 (0.04)	0.00 (0.00)
Indoor unit capacity type	FXFQ type									Others
	07	09	12	15	18	24	30	36	48	
Refrigerant amount (lbs. (kg)/unit)	0.36 (0.16)	0.33 (0.15)	0.30 (0.14)	0.26 (0.12)	0.61 (0.28)	0.53 (0.24)	0.61 (0.28)	0.53 (0.24)	0.36 (0.16)	0.00 (0.00)

Example for refrigerant branch using REFNET joint and REFNET header for systems and each pipe length as shown below. (Example 7.5. System piping (length) limitations on page 11.)

Outdoor system: REYQ264TTJU (REYQ144TTJU+REYQ120TTJU)

Branch Selector units

BS4Q54T × 1, BSQ60T × 1, BSQ96T × 1

Indoor units

FXMQ type: 18 × 1, 24 × 2, 36 × 1, 54 × 1

FXFQ type: 36 × 2

Other: 48 × 1

Liquid piping

a: φ3/4 × 60 ft.	e: φ1/4 × 15 ft.	i: φ3/8 × 20 ft.	m: φ3/8 × 15 ft.	r: φ1/2 × 10 ft.
b: φ5/8 × 20 ft.	f: φ3/8 × 10 ft.	j: φ3/8 × 10 ft.	n: φ3/8 × 15 ft.	t: φ1/2 × 15 ft.
c: φ1/2 × 10 ft.	g: φ3/8 × 10 ft.	k: φ3/8 × 10 ft.	o: φ3/8 × 10 ft.	
d: φ3/8 × 15 ft.	h: φ3/8 × 15 ft.	l: φ3/8 × 15 ft.	p: φ3/8 × 10 ft.	

Total length of liquid piping: 290 ft.

Total capacity of indoor unit: 104.5%

$$[D] = \overset{\uparrow}{0.25 \times 1} + \overset{\uparrow}{0.16 \times 2} + \overset{\uparrow}{0.25 \times 1} + \overset{\uparrow}{0.00 \times 1} + \overset{\uparrow}{0.53 \times 2} + \overset{\uparrow}{0.00 \times 1} = 1.88 \text{ lbs.}$$

FXMQ18x1 FXMQ24x2 FXMQ36x1 FXMQ54x1 FXFQ36x2 Other24x1

[C]: The smaller of [D] or 6.61 lbs. = 1.88 lbs.

$$R = \overset{\uparrow}{(60 \times 0.175)} + \overset{\uparrow}{20 \times 0.121} + \overset{\uparrow}{35 \times 0.081} + \overset{\uparrow}{160 \times 0.040} + \overset{\uparrow}{15 \times 0.019} \times 1.04 + \overset{\uparrow}{1.3} + \overset{\uparrow}{13.9} + \overset{\uparrow}{1.88}$$

a b c, r, t d, f, g, h, i, j, k, l, m, n, o, p e [A] [B] [C]

= 40.355 ⇒ 40.4 lbs.

Round off in units of 0.1 lbs.



INFORMATION

Piping length is considered the distance from the outdoor unit to the farthest indoor unit.

14.3. Method for adding refrigerant

14.3.1. Flow chart

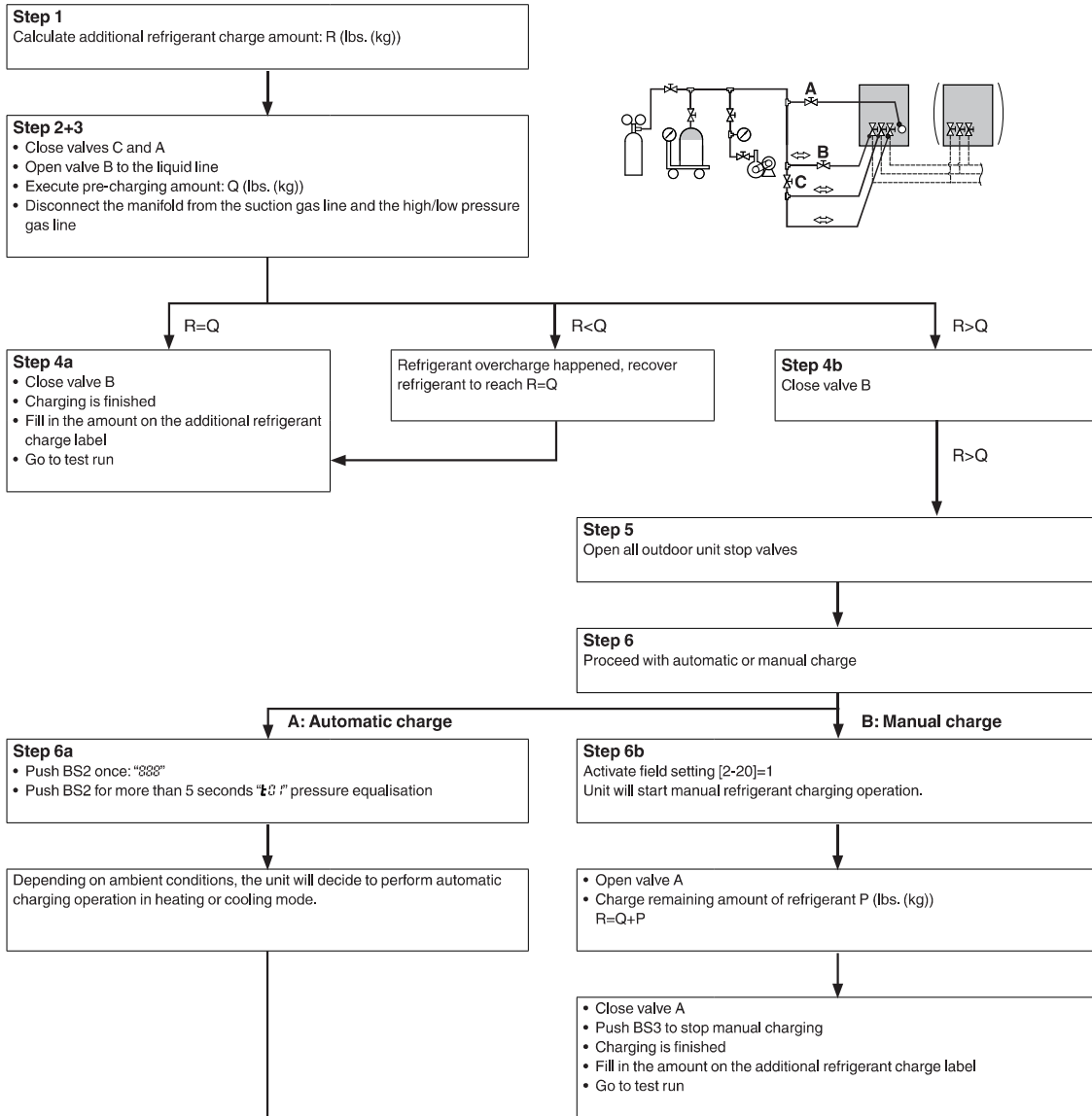

Continued on next page >>

<< Continuation of previous page

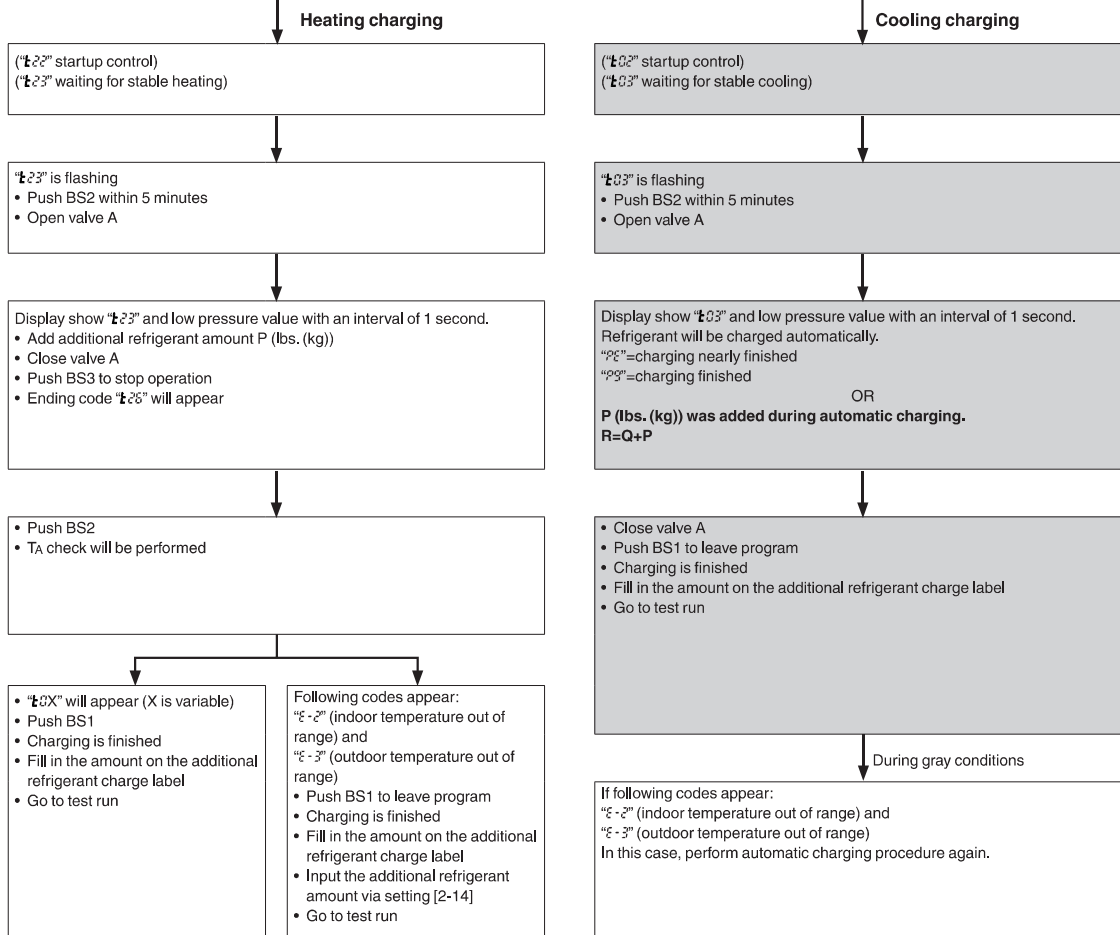

See figure location of valves next page for more information refer to the text in this chapter.

Be sure to charge the specified amount of refrigerant in liquid state. Since this refrigerant is a mixed refrigerant, adding it in gas form may cause the refrigerant composition to change, preventing normal operation.

- Before charging, check whether the refrigerant cylinder is equipped with a siphon tube or not.

Charge the liquid refrigerant with the cylinder in upright position.

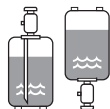

Charge the liquid refrigerant with the cylinder in upside-down position.

- Be sure to use tools exclusively for R410A to ensure required pressure resistance and to prevent foreign materials from mixing into the system.

NOTE
Charging with an unsuitable substance may cause explosions and accidents, so always make sure that the appropriate refrigerant (R410A) is charged. Refrigerant containers must be opened slowly.

CAUTION

- When charging a system, charging over the permissible quantity can cause liquid hammer.
- Always use protective gloves and protect your eyes when charging refrigerant.
- When the refrigerant charging procedure is done or when pausing, close the valve of the refrigerant tank immediately. If the tank is left with the valve open, the amount of refrigerant which is properly charged may get off point. More refrigerant may be charged by any remaining pressure after the unit has stopped.

NOTE

- If the power of some units is turned off, the charging procedure cannot be finished properly.
- In case of a multiple outdoor system, turn on the power of all outdoor units.
- Make sure to turn ON the power 6 hours before starting the operation. This is necessary to warm the crankcase by the electric heater.
- If operation is performed within 12 minutes after the indoor and outdoor units are turned on, the compressor will not operate before the communication is established in a correct way between outdoor unit(s) and indoor units.
- Before starting charging procedures, check if the segment display indication of the main printed circuit board (A1P) is as normal (see functions of the push button switches which are located on the main printed circuit board (A1P) on page 24). If a malfunction code is present, see 15.5. Malfunction code list on page 40.
- Make sure all connected indoor units are recognized (see 15.2. Monitoring function and field settings on page 33).
- Close the front panel before any refrigerant charge operation is executed. Without the front panel attached the unit cannot judge correctly whether it is operating properly or not.

NOTE

In case of maintenance and the system (outdoor unit+field piping+indoor units) does not contain any refrigerant any more (e.g., after refrigerant reclaim operation), the unit has to be charged with its original amount of refrigerant (refer to the nameplate on the unit) by pre-charging before the automatic charging function can be started.

14.3.2. Charging method

As explained during vacuum drying method, once vacuum drying is finished, additional refrigerant charging can start.

There are two methods to charge additional refrigerant. Use the selected method following the described procedure below.

- Adding refrigerant by using the automatic refrigerant charging function. See A: Adding refrigerant by using the automatic charging function on page 31. This method uses an automated method for charging refrigerant.
- Adding refrigerant by using the manual refrigerant charging function. See B: Adding refrigerant by using the manual charging function on page 31. This method uses a manual method for charging refrigerant.

A flow chart is available which gives an overview of the possibilities and actions to be taken (see 14.3.1. Flow chart on page 28).

To speed up the process of pre-charging refrigerant for large systems, it is recommended to first charge a portion of the refrigerant before performing automatic or manual charging. This step is included in below procedure. This step can be skipped, charging will take longer in such a case.

Follow the steps as described below and take into account whether you want to use the automatic charge function or not.

- 1 Calculate the additional amount of refrigerant to be added using the formula mentioned in 14.2. Calculating the additional refrigerant charge on page 26.
- 2 The first 22 lbs. (10 kg) of additional refrigerant can be charged without outdoor unit operation.

If the additional refrigerant amount is smaller than 22 lbs. (10 kg), perform the pre-charging procedure as explained in step 3 and 4a below.

If the additional refrigerant charge is larger than 22 lbs. (10 kg), perform step 3 till the end of the procedure.

- 3 Pre-charging can be done without compressor running by connecting the refrigerant tank only to the liquid stop valve service port (open valve C). Make sure that all outdoor unit stop valves, as well as valves A and C are closed.

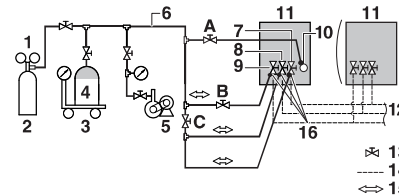

- 1 Gauge manifold
- 2 Nitrogen
- 3 Measuring instrument
- 4 Refrigerant R410A tank (siphon system)
- 5 Vacuum pump
- 6 Charge hose
- 7 High/low pressure gas pipe stop valve
- 8 Suction gas pipe stop valve
- 9 Liquid pipe stop valve
- 10 Refrigerant charge port
- 11 Outdoor unit
- 12 To Branch Selector unit (indoor unit)
- 13 Stop valve
- 14 Field piping
- 15 Gas flow
- 16 Stop valve service port
- A Valve A
- B Valve B
- C Valve C

- 4 a) If the calculated additional refrigerant amount is reached by above pre-charging procedure, close valve B.
b) If the total amount of refrigerant could not be charged by precharging, then close valve B and go to step 5. Follow step 6 depending on the chosen charging method.

INFORMATION

If the total additional refrigerant amount was reached in step 4 (by pre-charging only), record the amount of refrigerant that was added on the additional refrigerant charge label provided with the unit and attach it on the back side of the front panel. Perform the test procedure as described in 15.4. Test operation on page 39.

- 5 After pre-charging, perform the refrigerant charge operation as shown below and charge the remaining refrigerant of the additional charging amount through valve A. Open all outdoor units stop valves. Valves A, B and C must remain closed!

NOTE

- The refrigerant charging port is connected to the piping inside the unit. The unit's internal piping is already factory charged with refrigerant, so be careful when connecting the charge hose.
- After adding the refrigerant, do not forget to close the cover of the refrigerant charging port. The tightening torque for the cover is 8.48 to 10.3 ft·lb (11.5 to 13.9 N·m).
- In order to ensure uniform refrigerant distribution, it may take the compressor ±10 minutes to start up after the unit has started operation. This is not a malfunction.

A: Adding refrigerant by using the automatic charging function

INFORMATION

The automatic refrigerant charging has limits as described below. Out of these limits, the system cannot operate the automatic refrigerant charging:

- Outdoor temperature: 32°F (0°C) DB-109°F (43°C) DB.
- Indoor temperature: 50°F (10°C) DB-89°F (32°C) DB.
- Total indoor unit capacity: ≥ 80%

6a The remaining additional refrigerant charge can be charged by operating the outdoor unit by means of the automatic refrigerant charging operation mode. Depending on the ambient limitation conditions (see above), the unit will automatically decide which operation mode will be used to fulfill the automatic refrigerant charging: cooling or heating. If above conditions are fulfilled, cooling operation will be selected. If not, heating mode will start.

Procedure

- Idle (default) screen is shown.
- Push BS2 once, indication **888**.
- Push BS2 for more than 5 seconds, wait while the unit is preparing for operation. Segment display indication: **101** (pressure control is executed):
 - In case heating operation is started: indication **122** till **123** will be displayed (start up control; waiting stable heating operation).
 - In case cooling operation is started: indication **102** till **103** will be displayed (start up control; waiting stable cooling operation).
- When **123** or **103** starts flashing (ready for charging), push BS2 within 5 minutes. Open valve A. If BS2 is not pushed within 5 minutes, a malfunction code will appear:
 - Heating operation: **125** will be flashing. Push BS2 to restart the procedure.
 - Cooling operation: malfunction code **P22** will appear. Push BS1 to abort and restart the procedure.

Heating (middle segment indicates 2)

Charging will continue, the segment indication intermittently shows the current low pressure value and the status indication **123**.

When the remaining additional refrigerant amount is charged, close valve A immediately and push BS3 to stop charging operation.

After BS3 is pushed, the ending code **125** will appear. When BS2 is pushed, the unit will check whether the ambient conditions are favorable to execute the test run.

- If **101**, **102**, or **103** appears, push BS1 to finish the automatic charging function procedure. The ambient conditions are favorable to execute the test run.

- If the unit indicates **E-2**, or **E-3**, the ambient conditions are NOT favorable to execute the test run. Push BS1 to finish the automatic charging procedure.

INFORMATION

In case a malfunction code occurred during this automatic charging procedure, the unit will stop and indicate **125** flashing. Push BS2 to restart the procedure.

Cooling (middle segment indicates 0)

Automatic charging will continue, the segment indication shows the current low pressure value and the status indication **103** intermittent.

If the segment indication/user interface of indoor unit shows **P22** code, charging is almost finished. When the unit stops operating, close valve A immediately and check whether the segment indication/user interface of indoor unit shows **P23**. This indicates the automatic charging in cooling program was finished successfully.

INFORMATION

When the charging amount is little, the **P22** code may not be displayed, but instead the **P23** code will be displayed immediately.

When the required (calculated) additional refrigerant amount is already charged before **P22** or **P23** indication appears, close valve A and wait till **P23** is displayed.

If during the cooling operation for the automatic refrigerant charging the ambient conditions go beyond the allowable for this operation mode, the unit will indicate on the segment display the code **E-2** in case indoor temperature is out of range or **E-3** in case the outdoor temperature is out of range. In this case, when the additional refrigerant charging was not finished, step 6a has to be repeated.

INFORMATION

- When a malfunction is detected during the procedure (e.g. in case of closed stop valve), a malfunction code will be displayed. In that case, refer to 15.5. Malfunction code list on page 40 and solve the malfunction accordingly. Resetting the malfunction can be done by pushing BS1. The procedure can be restarted from 6a.
- Aborting the automatic refrigerant charging is possible by pushing BS1. The unit will stop and return to idle condition.

Perform the test procedure as described in 15.4.2. Test operation on page 39.

B: Adding refrigerant by using the manual charging function

6b The remaining additional refrigerant charge can be charged by operating the outdoor unit by means of the manual refrigerant charge operation mode:

- Turn on the power of the indoor units and outdoor unit.
 - Take all the precautions mentioned in **start-up and configuration** into account.
 - Activate outdoor unit setting [2-20]=1 to start manual refrigerant charge mode. Refer to page 34 for details.
- Result:** The unit will start operation. Valve A can be opened. Charging of remaining additional refrigerant can be done. When the remaining calculated additional refrigerant amount is added, close valve A and push BS3 to stop the manual refrigerant charging procedure.

INFORMATION

The manual refrigerant charge operation will automatically stop within 30 minutes. If charging is not completed after 30 minutes, perform the additional refrigerant charging operation again.

Perform the test procedure as described in 15.4.2. Test operation on page 39.

i INFORMATION

- When a malfunction is detected during the procedure (e.g., in case of closed stop valve), a malfunction code will be displayed. In that case, refer to 15.5. Malfunction code list on page 40 and solve the malfunction accordingly. Resetting the malfunction can be done by pushing BS3. The procedure can be restarted from 6b).
- Aborting the manual refrigerant charge is possible by pushing BS3. The unit will stop and return to idle condition.

Information which may occur during additional refrigerant charging procedures:

P8: Indoor unit freeze up prevention.

Action: Close valve A immediately. Push BS1 to reset. Retry automatic charging procedure.

P2: Unusual low pressure on suction line.

Action: Close valve A immediately. Push BS1 to reset. Check following items before retrying automatic charging procedures:

- Check if gas pipe stop valves are opened correctly.
- Check if the valve of the refrigerant cylinder is opened.
- Check if air inlet and outlet of indoor units are not obstructed.

ℰ - 2: Indoor temperature is out of range.

ℰ - 3: Outdoor temperature is out of range.

ℰ - 5: An indoor unit which is not compatible with automatic refrigerant charging functionality is installed (e.g., Mini-split indoor unit, etc.)

Other malfunction code: close valve A immediately. Confirm the malfunction code and take corresponding action, 15.5. Malfunction code list on page 40.

14.3.3. Final charge adjustment

It is not necessary to do this final adjustment normally, but perform the following operation only when if the most adequate refrigerant for the best performance is required.

The outdoor temperature must be between 60°F (16°C) and 97°F (36 °C).

Purge gauge lines. Connect service gauge manifold to the service port between the compressor and the reversing valve in each outdoor unit. Run the system for 30 minutes in cooling by the forced operation using the field setting mode [2-6] (value 0: OFF, 1:ON) (Refer to 15.2. Monitoring function and field settings.) to allow pressures to stabilize, then check subcooling as detailed in the following sections.

Subcooling = Sat. Liquid Temp. – Liquid Line Temp.

- 1 Temporarily install a thermometer on the liquid line between the coil and the EV in each outdoor unit. Ensure the thermometer makes adequate contact and is insulated for best possible readings. Use liquid line temperature to determine sub cooling.
- 2 Check subcooling for each outdoor unit and calculate the average subcooling of the outdoor unit. Systems should have a subcooling of 11±3°F (6±2°C).
 - a. If average subcooling is low, add charge to raise subcooling to 11±3°F (6±2°C) (The maximum additional charge is 4.4 lbs. (2kg))
 - b. If average subcooling is high, remove charge to lower the subcooling to 11±3°F (6±2°C)

14.3.4. Checks after adding refrigerant

- Are all stop valves open?
- Is the amount of refrigerant, that has been added, recorded on the refrigerant charge label?

! NOTE

Make sure to open all stop valves after (pre-) charging the refrigerant. Operating with the stop valves closed will damage the compressor.

15. Start-up and configuration

i INFORMATION

It is important that all information in this chapter is read sequentially by the installer and that the system is configured as applicable.

! DANGER: ELECTRICAL SHOCK

See Safety considerations on page i.

15.1. Checks before initial start up

After the installation of the unit, first check the following items. Once all below checks are fulfilled, the unit must be closed, only then can the unit be powered up.

- 1 Installation

Check that the unit is properly installed, to avoid abnormal noises and vibrations when starting up the unit.
- 2 Field wiring

Be sure that the field wiring has been carried out according to the instructions described in 9. Field wiring on page 18, according to the wiring diagrams and according to the applicable legislation.
- 3 Power supply voltage

Check the power supply voltage on the local supply panel. The voltage must correspond to the voltage on the identification label of the unit.
- 4 Ground wiring

Be sure that the ground wires have been connected properly and that the ground terminals are tightened.
- 5 Insulation test of the main power circuit

Using a megatester for 500 V, check that the insulation resistance of 1 MΩ or more is attained by applying a voltage of 500 V DC between power terminals and ground. Never use the megatester for the transmission wiring.
- 6 Fuses, circuit breakers, or protection devices

Check that the fuses, circuit breakers, or the locally installed protection devices are of the size and type specified in 9. Field wiring on page 18. Be sure that neither a fuse nor a protection device has been bypassed.
- 7 Internal wiring

Visually check the control box and the inside of the unit on loose connections or damaged electrical components.
- 8 Pipe size and pipe insulation

Be sure that correct pipe sizes are installed and that the insulation work is properly executed.
- 9 Stop valves

Be sure that all stop valves are open.
- 10 Damaged equipment

Check the inside of the unit on damaged components or squeezed pipes.

- 11 Refrigerant leak**
Check the inside of the unit on refrigerant leakage. If there is a refrigerant leak, try to repair the leak. If the repair is unsuccessful, call your local dealer. Do not touch any refrigerant which has leaked out from refrigerant piping connections. This may result in frostbite.
- 12 Oil leak**
Check the compressor for oil leakage. If there is an oil leak, try to repair the leak. If the repairing is unsuccessful, call your local dealer.
- 13 Air inlet/outlet**
Check that the air inlet and outlet of the unit is not obstructed by paper sheets, cardboard, or any other material.
- 14 Record the contents of field setting.**
Record them on the accessory **REQUEST FOR THE INDICATION** label.
And attach the label on the back side of the front panel.
- 15 Record the installation date.**
Record the installation date on the accessory **REQUEST FOR THE INDICATION** label.
And attach the label on the back side of the front panel.

15.2. Monitoring function and field settings

The operation of the outdoor unit can further be defined by changing some field settings. Next to making field settings it is also possible to confirm the current operation parameters of the unit. The setting can also be performed via the PC configuration software.

Below relevant Monitoring mode (mode 1) and Field setting mode (mode 2) settings are explained in detail. How to access them, how to change the value of the settings and how to confirm them is explained in 13. Making field settings on page 24. In that chapter, an example is given on how to make a setting. It is advised to check this procedure before accessing, checking and changing below settings.

Once the default situation of the segment indication is confirmed (see 13. Making field settings on page 24), the mode 1 and mode 2 can be accessed.
Making settings is done via the master outdoor unit.

15.2.1. Mode 1

Mode 1 can be used to monitor the current situation of the outdoor unit. Some field setting contents can be monitored as well. Below the settings in mode 1 are explained.

- [1-0]= shows whether the unit you check is a master, sub 1 or sub 2 unit
 - No indication=undefined situation
 - 0=outdoor unit is master unit
 - 1=outdoor unit is sub 1 unit
 - 2=outdoor unit is sub 2 unit
 Master, sub 1 and sub 2 indications are relevant in multiple outdoor unit system configurations. The allocation of which outdoor unit is master, sub 1 or sub 2 are decided by the unit's logic.
The master unit should be used to input field settings in mode 2.
- [1-1]= shows the status of low noise operation.
 - 1=unit is currently operating under low noise restrictions
 - 0=unit is currently not operating under low noise restrictions
 Low noise operation reduces the sound generated by the unit compared to nominal operating conditions.

Low noise operation can be set in mode 2. There are two methods to activate low noise operation of the outdoor unit system.
The first method is to enable an automatic low noise operation during night time by field setting. The unit will operate at the selected low noise level during the selected time frames. The second method is to enable low noise operation based on an external input. For this operation an optional accessory is required.

- [1-2]= shows the status of power consumption limitation operation.
 - 1=unit is currently operating under power consumption limitation
 - 0=unit is currently not operating under power consumption limitations
 Power consumption limitation reduces the power consumption of the unit compared to nominal operating conditions. Power consumption limitation can be set in mode 2. There are two methods to activate power consumption limitation of the outdoor unit system.
The first method is to enable a forced power consumption limitation by field setting. The unit will always operate at the selected power consumption limitation.
The second method is to enable power consumption limitation based on an external input. For this operation an optional accessory is required.
- [1-5]= shows the current T_e target parameter position.
Refer to 15.3. Energy saving and optimum operation on page 36 for more details about the contents of this value.
- [1-6]= shows the current T_c target parameter position.
Refer to 15.3. Energy saving and optimum operation on page 36 for more details about the contents of this value.
- [1-10]= shows the total number of connected indoor units.
It can be convenient to check if the total number of indoor units which are installed match the total number of indoor units which are recognized by the system. In case there is a mismatch, it is advised to check the communication wiring path between outdoor and indoor units (F1/F2 communication line).
- [1-13]= shows the total number of connected outdoor units.
It can be convenient to check if the total number of outdoor units which are installed matches the total number of outdoor units which are recognized by the system. In case there is a mismatch, it is advised to check the communication wiring path between outdoor and outdoor units.
- [1-17]= shows the latest malfunction code.
- [1-18]= shows the 2nd last malfunction code.
- [1-19]= shows the 3rd last malfunction code.
When the latest malfunction codes were reset by accident on an indoor unit user interface, they can be checked again through this monitoring settings. For the content or reason behind the malfunction code see 15.5. Malfunction code list on page 40, where most relevant malfunction codes are explained. Detailed information about malfunction codes can be consulted in the service manual of this unit.
- [1-40]= shows the current cooling comfort setting. See 15.3. Energy saving and optimum operation on page 36 for more details about this setting.
- [1-41]= shows the current heating comfort setting. See 15.3. Energy saving and optimum operation on page 36 for more details about this setting.

15.2.2. Mode 2

Mode 2 is used to change the field settings of the system. Consulting the current field setting value and changing the current field setting value is possible.

In general, normal operation can be resumed without special intervention after changing field settings.

Some field settings are used for special operation (e.g., 1 time operation, recovery/vacuumping setting, manual adding refrigerant setting, etc.). In such a case, it is required to abort the special operation before normal operation can restart. It will be indicated in below explanations.

[2-0]= Cool/Heat selection setting

Cool/Heat selection setting is used in case the optional Cool/Heat selector (KRC19-26A) is used. Depending on the outdoor unit setup (single outdoor unit setup or multi outdoor unit setup), the correct setting should be chosen. More details on how to use the Cool/Heat selector option can be found in the manual of the Cool/Heat selector. Default value=0.

- 0=Each individual outdoor unit can select Cool/Heat operation (by Cool/Heat selector if installed).
- 1=Master unit decides Cool/Heat operation when outdoor units are connected in multiple system combination (a)
- 2=Sub unit for Cool/Heat operation when outdoor units are connected in multiple system combination (a)

Change [2-0]=0, 1 or 2 in function of required functionality.

[2-8]= T_e target temperature during cooling operation

Default value=0.

Value [2-8]	T _e target
0	Auto (default)
2	43°F (6°C)
3	45°F (7°C)
4	46°F (8°C)
5	48°F (9°C)
6	50°F (10°C)
7	52°F (11°C)

Change [2-8]=0, 2-7 in function of required operation method during cooling.

For more information and advice about the impact of these settings, see 15.3. Energy saving and optimum operation on page 36.

[2-9]= T_c target temperature during heating operation

Default value=0.

Value [2-9]	T _c target
0	Auto (default)
1	106°F (41°C)
3	109°F (43°C)
6	115°F (46°C)

Change [2-9]=0, 1, 3 or 6 in function of required operation method during heating.

For more information and advice about the impact of these settings, see 15.3. Energy saving and optimum operation on page 36.

[2-12]= Enable the low noise function and/or power consumption limitation via external control adaptor (DTA104A61/62)

If the system needs to be running under low noise operation or under power consumption limitation conditions when an external signal is sent to the unit, this setting should be changed. This setting will only be effective when the optional external control adaptor (DTA104A61/62) is installed.

Default value=0.

To activate this function change [2-12]=1.

[2-18]= Fan high static pressure setting

In order to increase the static pressure the outdoor unit fan is delivering, this setting should be activated. For details about this setting, see technical specifications.

Default value=0.

To activate this function change [2-18]=1.

[2-20]= Manual additional refrigerant charge

In order to add the additional refrigerant charge amount in a manual way (without automatic refrigerant charging functionality), following setting should be applied.

Further instructions regarding the different ways to charge additional refrigerant into your system can be found in chapter 14.3. Method for adding refrigerant on page 28.

Default value=0.

To activate this function change [2-20]=1.

To stop the manual additional refrigerant charge operation (when the required additional refrigerant amount is charged), push BS3. If this function was not aborted by pushing BS3, the unit will stop its operation after 30 minutes. If 30 minutes was not sufficient to add the needed refrigerant amount, the function can be reactivated by changing the field setting again.

[2-21]= Refrigerant recovery/vacuumping mode

In order to achieve a free pathway to reclaim refrigerant out of the system or to remove residual substances or to vacuum the system it is necessary to apply a setting which will open required valves in the refrigerant circuit so the reclaim of refrigerant or vacuumping process can be done properly.

Default value=0.

To activate function change [2-21]=1.

To stop the refrigerant recovery/vacuumping mode, push BS3. If BS3 is not pushed, the system will remain in refrigerant recovery/vacuumping mode.

[2-22]= Automatic low noise setting and level during night time

By changing this setting, you activate the automatic low noise operation function of the unit and define the level of operation. Depending on the chosen level, the noise level will be lowered (3: Level 3<2: Level 2<1: Level 1).

The start and stop moments for this function are defined under setting [2-26] and [2-27].

Default value=0.

To activate function change [2-22]=1, 2 or 3.

[2-25]= Low noise operation level via the external control adaptor

If the system needs to be running under low noise operation conditions when an external signal is sent to the unit, this setting defines the level of low noise that will be applied (3: Level 3<2: Level 2<1: Level 1).

This setting will only be effective when the optional external control adaptor (DTA104A61/62) is installed and the setting [2-12] was activated.

Default value=2.

To activate function change [2-25]=1, 2 or 3.

[2-26]= Low noise operation start time
 Change [2-26]=1, 2 or 3 in function of required timing.
 Default value=2.

Value [2-26]	Start time automatic low noise operation (approximately)
1	8:00 p.m.
2	10:00 p.m. (default)
3	12:00 a.m.

This setting is used in conjunction with setting [2-22].

[2-27]= Low noise operation stop time
 Default value=3.

Value [2-27]	Start time automatic low noise operation (approximately)
1	6:00 a.m.
2	7:00 a.m.
3	8:00 a.m. (default)

This setting is used in conjunction with setting [2-22].

[2-30]= Power consumption limitation level (step 1) via the external control adaptor (DTA104A61/62)

If the system needs to be running under power consumption limitation conditions when an external signal is sent to the unit, this setting defines the level power consumption limitation that will be applied for step 1. The level is according to the table.
 Default value=3.

Change [2-30]=1, 2, 3, 4, 5, 6, 7 or 8 in function of required limitation.

Value [2-30]	Power consumption limitation (approximately)
1	60%
2	65%
3	70% (default)
4	75%
5	80%
6	85%
7	90%
8	95%

[2-31]= Power consumption limitation level (step 2) via the external control adaptor (DTA104A61/62)

If the system needs to be running under power consumption limitation conditions when an external signal is sent to the unit, this setting defines the level power consumption limitation that will be applied for step 2. The level is according to the table.
 Default value=1.

Change [2-31]=1, 2 or 3 in function of required limitation.

Value [2-31]	Power consumption limitation (approximately)
1	40% (default)
2	50%
3	55%

[2-32]= Forced, all time, power consumption limitation operation (no external control adaptor is required to perform power consumption limitation)

If the system always needs to be running under power consumption limitation conditions, this setting activates and defines the level power consumption limitation that will be applied continuously. The level is according to the table.
 Default value=0 (OFF).

Value [2-32]	Restriction reference
0	Function not active (default)
1	Follows [2-30] setting
2	Follows [2-31] setting

Change [2-32]=0, 1 or 2 in function of required limitation.

[2-34]= Indoor unit fan tap setting

Indoor units fan speed limitation related to connection capacity and outdoor air temperature for energy saving.

Default value=0.

Value [2-34]	Indoor unit fan tap setting
0	Fan speed is limited to L tap when indoor units capacity \geq 130%.
1	In heating mode, fan speed is limited to L tap when indoor units capacity \geq 130%.
2	Fan speed follows a setting of the remote controller (not limited by indoor units connection capacity).
3	Fan speed is limited to L tap when outdoor air temperature goes down to below 85.1°F (29.5°C) and indoor air temperature is in condition A (*). It returns to remote controller setting when outdoor air temperature goes up to over 90.5°F (32.5°C) or indoor air temperature is in condition B (**).
4	Fan speed is limited to L tap when outdoor air temperature goes down to below 74.3°F (23.5°C) and indoor air temperature is in condition A (*). It returns to remote controller setting when outdoor air temperature goes up to over 79.7°F (26.5°C) or indoor air temperature is in condition B (**).
5	Fan speed is limited to L tap when outdoor air temperature goes down to below 66.7°F (19.3°C) and indoor air temperature is in condition A (*). It returns to remote controller setting when outdoor air temperature goes up to over 72.1°F (22.3°C) or indoor air temperature is in condition B (**).
6	Fan speed is limited to L tap when outdoor air temperature goes down to below 85.1°F (29.5°C). It returns to remote controller setting when outdoor air temperature goes up to over 90.5°F (32.5°C).
7	Fan speed is limited to L tap when outdoor air temperature goes down to below 74.3°F (23.5°C). It returns to remote controller setting when outdoor air temperature goes up to over 79.7°F (26.5°C).
8	Fan speed is limited to L tap when outdoor air temperature goes down to below 66.7°F (19.3°C). It returns to remote controller setting when outdoor air temperature goes up to over 72.1°F (22.3°C).

* Indoor condition A: Temperature difference (indoor air temperature – set temperature) is more than –2.7°F (–1.5°C) and less than 5.4°F (3°C).

** Indoor condition B: Temperature difference (indoor air temperature – set temperature) is –2.7°F (–1.5°C) or less, or 5.4°F (3°C) or more.

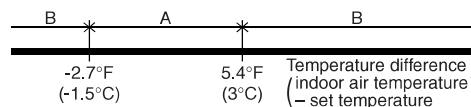

[2-35]= Height difference setting

Default value=1.
 In case the outdoor unit is installed in the lowest position (indoor units are installed on a higher position than outdoor units) and the height difference between the highest indoor unit and the outdoor unit exceeds 130 ft. (40 m), the setting [2-35] should be changed to 0.
 Other changes/limitations to the circuit apply, for more information see 7.5. System piping (length) limitations on page 11.

[2-45]= Technical cooling

Default value=0.

Value [2-45]	Description
0	No technical cooling available. (default)
1	Technical cooling available.

This setting is not applicable to multi Branch Selector unit.
 For more information about this setting, refer to the service manual.

[2-47]= T_e target temperature during heat recovery operation

Default value=0.

Value [2-47]	T _e target
0	Auto (default)
2	43°F (6°C)
3	45°F (7°C)
4	46°F (8°C)
5	48°F (9°C)
6	50°F (10°C)
7	52°F (11°C)

Change [2-47]=0, 2-7 in function of required operation method during cooling.
 For more information and advice about the impact of these settings, see 15.3. Energy saving and optimum operation.

[2-49]= Height difference setting

Default value=0.
 In case the outdoor unit is installed in the highest position (indoor units are installed on a lower position than outdoor units) and the height difference between the lowest indoor unit and the outdoor unit exceeds 164 ft. (50 m), the setting [2-49] has to be changed to 1.
 Other changes/limitations to the circuit apply, for more information see 7.5. System piping (length) limitations on page 11.

[2-81]= Cooling comfort setting

Default value=1.

Value [2-81]	Cooling comfort setting
0	Eco
1	Mild (default)
2	Quick
3	Powerful

Change [2-81]=0, 1, 2 or 3 in function of required limitation.
 This setting is used in conjunction with setting [2-8] and [2-47].
 For more information and advice about the impact of these settings, see 15.3. Energy saving and optimum operation.

[2-82]= Heating comfort setting

Default value=1.

Value [2-82]	Heating comfort setting
0	Eco
1	Mild (default)
2	Quick
3	Powerful

Change [2-82]=0, 1, 2 or 3 in function of required limitation.
 This setting is used in conjunction with setting [2-9].
 For more information and advice about the impact of these settings, see 15.3. Energy saving and optimum operation.

15.3. Energy saving and optimum operation

REYQ-T units are equipped with advanced energy saving functionality. Depending on the priority, emphasizes can be put on energy saving or comfort level. Several parameters can be selected, resulting in the optimal balance between energy consumption and comfort for the particular application.

Several patterns are available and explained below. Modify the parameters to the needs of your building and to realize the best balance between energy consumption and comfort.

15.3.1. Three main operation methods are available:

• Basic

The refrigerant temperature is fixed independent from the situation. It corresponds to the standard operation which is known and can be expected from/under previous VRV systems:

- To activate this operation method under cooling operation: change field setting [2-8]=2 and [2-47]=2.
- To activate this operation method under heating operation: change field setting [2-9]=6.

• Automatic

The refrigerant temperature is set depending on the outdoor ambient conditions. As such adjusting the refrigerant temperature to match the required load (which is also related to the outdoor ambient conditions).

E.g., when your system is operating in cooling, you do not need as much cooling under low outdoor ambient temperatures (e.g., 77°F (25°C)) as under high outdoor ambient temperatures (e.g., 95°F (35°C)).

Using this idea, the system automatically starts increasing its refrigerant temperature, automatically reducing the delivered capacity and increasing the system's efficiency.

- To activate this operation method under cooling operation: change field setting [2-8]=0 (default) and [2-47]=0 (default).

E.g., when your system is operating in heating, you do not need as much heating under high outdoor ambient temperatures (e.g., 59°F (15°C)) as under low outdoor ambient temperatures (e.g., 23°F (-5°C)).

Using this idea, the system automatically starts decreasing its refrigerant temperature, automatically reducing the delivered capacity and increasing the system's efficiency.

- To activate this operation method under heating operation: change field setting [2-9]=0 (default).

• **Hi-sensible/economic (cooling/heating)**

The refrigerant temperature is set higher/lower (cooling/heating) compared to basic operation. The focus under high sensible mode is comfort feeling for the customer.

The selection method of indoor units is important and has to be considered as the available capacity is not the same as under basic operation. For details concerning to Hi-sensible applications, please contact your dealer.

- To activate this setting under cooling operation: change field setting [2-8] and [2-47] to the appropriate value, matching the requirements of the pre-designed system containing a high sensible solution.

Value [2-8] and [2-47]	Te target
3	45°F (7°C)
4	46°F (8°C)
5	48°F (9°C)
6	50°F (10°C)
7	52°F (11°C)

- To activate this setting under heating operation: change field setting [2-9] to the appropriate value, matching the requirements of the pre-designed system containing a high sensible solution.

Value [2-9]	Tc target
1	106°F (41°C)
3	109°F (43°C)

15.3.2. Several comfort settings are available

For each of above modes a comfort level can be selected. The comfort level is related to the timing and the effort (energy consumption) which is put in achieving a certain room temperature by temporarily changing the refrigerant temperature to different values in order to achieve requested conditions more quickly.

• **Powerful**

Overshoot (during heating operation) or undershoot (during cooling operation) is allowed compared to the requested refrigerant temperature, in order to achieve the required room temperature very fast. The overshoot is allowed from the start up moment.

In case of cooling operation the evaporating temperature is allowed to go down to 37°F (3°C) on temporary base depending on the situation.

In case of heating operation the condense temperature is allowed to go up to 120°F (49°C) on temporary base depending on the situation.

When the request from the indoor units becomes more moderate, the system will eventually go to the steady state condition which is defined by the operation method above.

- To activate the powerful comfort setting under cooling operation, change field setting [2-81]=3.

This setting is used in conjunction with setting [2-8] and [2-47].

- To activate the powerful comfort setting under heating operation, change field setting [2-82]=3.

This setting is used in conjunction with setting [2-9].

• **Quick**

Overshoot (during heating operation) or undershoot (during cooling operation) is allowed compared to the requested refrigerant temperature, in order to achieve the required room temperature very fast. The overshoot is allowed from the start up moment.

In case of cooling operation the evaporating temperature is allowed to go down to 43°F (6°C) on temporary base depending on the situation.

In case of heating operation the condense temperature is allowed to go up to 115°F (46°C) on temporary base depending on the situation.

When the request from the indoor units becomes more moderate, the system will eventually go to the steady state condition which is defined by the operation method above.

- To activate the quick comfort setting under cooling operation, change field setting [2-81]=2.

This setting is used in conjunction with setting [2-8] and [2-47].

- To activate the quick comfort setting under heating operation, change field setting [2-82]=2.

This setting is used in conjunction with setting [2-9].

• **Mild**

Overshoot (during heating operation) or undershoot (during cooling operation) is allowed compared to the requested refrigerant temperature, in order to achieve the required room temperature very fast. The overshoot is not allowed from the start up moment. The start up occurs under the condition which is defined by the operation mode above.

In case of cooling operation the evaporating temperature is allowed to go down to 43°F (6°C) on temporary base depending on the situation.

In case of heating operation the condense temperature is allowed to go up to 115°F (46°C) on temporary base depending on the situation.

When the request from the indoor units becomes more moderate, the system will eventually go to the steady state condition which is defined by the operation method above.

The start up condition is different from the powerful and quick comfort setting.

- To activate the mild comfort setting under cooling operation, change field setting [2-81]=1.

This setting is used in conjunction with setting [2-8] and [2-47].

- To activate the mild comfort setting under heating operation, change field setting [2-82]=1.

This setting is used in conjunction with setting [2-9].

• **Eco**

The original refrigerant temperature target, which is defined by the operation method (see above) is kept without any correction, unless for protection control.

- To activate the mild comfort setting under cooling operation, change field setting [2-81]=0.

This setting is used in conjunction with setting [2-8] and [2-47].

- To activate the mild comfort setting under heating operation, change field setting [2-82]=0.

This setting is used in conjunction with setting [2-9].

Example: Automatic mode during cooling

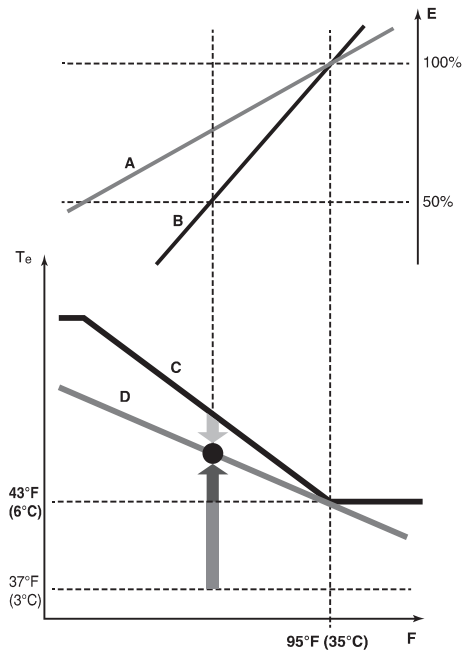

- A Actual load curve
- B Virtual load curve (initial capacity automatic mode)
- C Virtual target value (initial evaporation temperature value automatic mode)
- D Required evaporation temperature value
- E Load factor
- F Outside air temperature
- Te Evaporating temperature
- Quick
- Powerful
- Mild

Example: Automatic mode during cooling

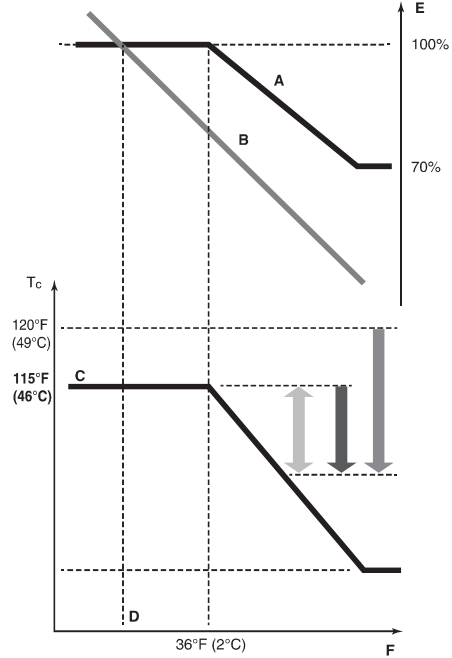

- A Virtual load curve (default automatic mode peak capacity)
- B Load curve
- C Virtual target value (initial condensation temperature value automatic mode)
- D Design temperature
- E Load factor
- F Outside air temperature
- Tc Condensing temperature
- Quick
- Powerful
- Mild

Room temperature evolution:

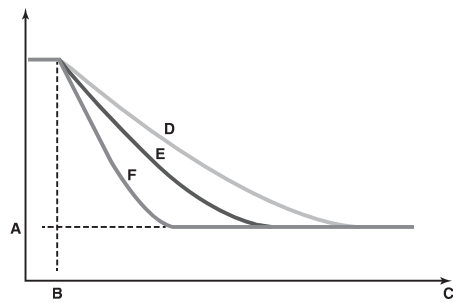

- A Indoor unit set temperature
- B Operation start
- C Operating time
- D Mild
- E Quick
- F Powerful

Room temperature evolution:

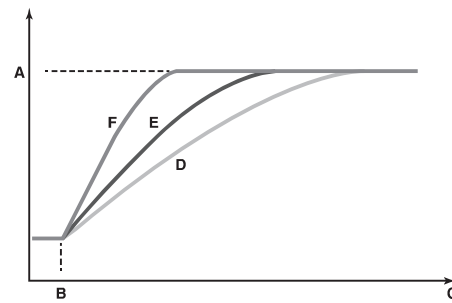

- A Indoor unit set temperature
- B Operation start
- C Operating time
- D Mild
- E Quick
- F Powerful

No matter which control is selected, variations on the behavior of the system are still possible due to protection controls to keep the unit operating under reliable conditions. The intentional target, however, is fixed and will be used to obtain the best balance between energy consumption and comfort, depending on the application type.

15.4. Test operation

After installation and once the field settings are defined, the installer is obliged to verify correct operation. Therefore a test run must be performed according to the procedures described below.

15.4.1. Precautions before starting test operation

During test operation, the outdoor units, the Branch Selector units and the indoor units will start up:

- Make sure that the preparations of all Branch Selector units and all indoor units are finished (field piping, electrical wiring, air purge, etc.). See installation manual of the Branch Selector units and the indoor units for details.

⚠ CAUTION

Do not insert fingers, rods or other objects into the air inlet or outlet. When the fan is rotating at high speed, it will cause injury.

⚠ CAUTION

Do not perform the test operation while working on the Branch Selector units and the indoor units.

When performing the test operation, not only the outdoor units, but the connected indoor units will operate as well.

Working on indoor units or Branch Selector units while performing a test operation is dangerous.

⚠ CAUTION

- During tests never pressurize the appliances with a pressure higher than the maximum allowable pressure (as indicated on the nameplate of the unit).
- If refrigerant gas leaks, ventilate the area immediately. Toxic gas may be produced if refrigerant gas comes into contact with fire.
- Never directly touch any accidental leaking refrigerant. This could result in severe wounds caused by frostbite.
- Test run is possible for ambient temperatures between -4°F and 95°F (-20°C and 35°C).

⚠ DANGER: DO NOT TOUCH PIPING AND INTERNAL PARTS

See Safety considerations on page i.

⚠ DANGER: ELECTRICAL SHOCK

See Safety considerations on page i.

- Provide a logbook and machine card.
In accordance with the applicable legislation, it may be necessary to provide a logbook with the equipment containing at least: information on maintenance, repair work, results of tests, stand-by periods, etc.

ℹ INFORMATION

Note that during the first running period of the unit, required power input may be higher. This phenomenon originates from the compressor that requires a 50 hour run elapse before reaching smooth operation and stable power consumption. Reason is that the scroll is made out of iron and that it takes some time to smooth the surfaces that make contact.

⚠ NOTE

To protect the compressor, be sure to turn on the power supply 6 hours before starting operation.

15.4.2. Test operation

The procedure below describes the test operation of the complete system. This operation checks and judges following items:

- Check of wrong wiring (communication check with indoor units).
- Check of the stop valves opening.
- Judgment of piping length.

On top of this system test operation, Branch Selector units and indoor units operation should also be checked separately.

- Make sure to carry out the system test operation after the first installation. Otherwise, the malfunction code U3 will be displayed on the user interface and normal operation or individual Branch Selector unit and indoor unit test run cannot be carried out.
- Abnormalities on Branch Selector units and indoor units cannot be checked for each unit separately. After the test operation is finished, check the Branch Selector units and the indoor units one by one by performing a normal operation using the user interface. Refer to the Branch Selector units and the indoor units installation manual for more details concerning the individual test run.

ℹ INFORMATION

- It may take 10 minutes to achieve a uniform refrigerant state before the compressor starts.
- During the test operation, the refrigerant running sound or the magnetic sound of a solenoid valve may become loud and the display indication may change.
These are not malfunctions.

Procedure

- 1 Close all front panels in order to not let it be the cause of misjudgment.
- 2 Make sure all field settings you want are set; see 15.2. Monitoring function and field settings on page 33.
- 3 Turn ON the power to the outdoor units, the connected Branch Selector units and the connected indoor units.

⚠ NOTE

Be sure to turn on the power 6 hours before operation in order to have power running to the crankcase heater and to protect the compressor.

- 4 Make sure the default (idle) situation is existing; see 13.2. Operating the push buttons and DIP switches on the printed circuit board on page 24. Push BS2 for 5 seconds or more. The unit will start test operation.

- The test operation is automatically carried out, the outdoor unit display will indicate **E3** and the indication **Test operation** and **Under centralized control** will display on the user interface of indoor units.

Steps during the automatic system test run procedure:

- **E01**: control before start up (pressure equalization)
- **E02**: cooling start up control
- **E03**: cooling stable condition
- **E04**: communication check
- **E05**: stop valve check
- **E06**: pipe length check
- **E07**: refrigerant amount check
- **E08**: detailed refrigerant situation check
- **E09**: pump down operation
- **E10**: unit stop

- During the test operation, it is not possible to stop the unit operation from a user interface. To abort the operation, press BS3. The unit will stop after ±30 seconds.

5 Check the test operation results on the outdoor unit segment display.

- Normal completion: no indication on the segment display (idle).
- Abnormal completion: indication of malfunction code on the segment display.
Refer to 15.4.3. Correcting after abnormal completion of the test operation to take actions for correcting the abnormality. When the test operation is fully completed, normal operation will be possible after 5 minutes.

15.4.3. Correcting after abnormal completion of the test operation

The test operation is only completed if there is no malfunction code displayed on the user interface or outdoor unit segment display. In case of a displayed malfunction code, perform correcting actions as explained in the malfunction code table. Carry out the test operation again and confirm that the abnormality is properly corrected.

INFORMATION

Refer to the installation manual of the indoor unit for other detailed malfunction codes related to indoor units.

15.5. Malfunction code list

In case of a displayed malfunction code, perform correcting actions as explained in the malfunction code table.

After correcting the abnormality, press BS3 to reset the malfunction code and retry operation.

The malfunction code which is displayed on the outdoor unit will indicate a main malfunction code and a sub code. The sub code indicates more detailed information about the malfunction code. The malfunction code will be displayed intermittent.

Example:

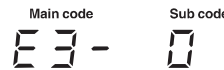

With an interval of 1 second, the display will switch between main code and sub code.

Malfunction code		Contents	Solution
Main code	Sub code Master/sub 1/sub 2		
E3	01/03/05	<ul style="list-style-type: none"> High pressure switch is activated. (S1PH, S2PH)-A1P (X2A, X3A) High pressure switch connectors are detached. -A1P (X2A, X3A, X4A) 	<ul style="list-style-type: none"> Check stop valves situation or abnormalities in (field) piping or airflow over air cooled coil. Securely connect each connector. Refer to the wiring diagram attached to the back of the control box cover.
	02/04/06	<ul style="list-style-type: none"> Stop valves are closed. Refrigerant overcharge. 	<ul style="list-style-type: none"> Open stop valves. Check refrigerant amount and recharge.
	13/14/15	Liquid pipe stop valve is closed.	Open liquid pipe stop valve.
	18	<ul style="list-style-type: none"> Stop valves are closed. Refrigerant overcharge. 	<ul style="list-style-type: none"> Open stop valves. Check refrigerant amount and recharge.
E4	01/02/03	Low pressure malfunction: <ul style="list-style-type: none"> Stop valves are closed. Refrigerant shortage. Reverse connection of high/low pressure gas pipe and suction gas pipe of Branch Selector unit. 	<ul style="list-style-type: none"> Open stop valves. Check refrigerant amount and recharge.
E9	01/05/08	Electronic expansion valve malfunction (Y1E)-A1P (X21A)	Check connection on printed circuit board or actuator.
	03/06/09	Electronic expansion valve malfunction (Y2E)-A1P (X22A)	Check connection on printed circuit board or actuator.
	04/07/10	Electronic expansion valve malfunction (Y3E)-A1P (X23A)	Check connection on printed circuit board or actuator.
	26/27/28	Electronic expansion valve malfunction (Y4E)-A1P (X25A)	Check connection on printed circuit board or actuator.
	29/34/39	Electronic expansion valve malfunction (Y5E)-A8P (X8A)	Check connection on printed circuit board or actuator.
	31/36/41	Electronic expansion valve malfunction (Y6E)-A8P (X10A)	Check connection on printed circuit board or actuator.

Malfunction code		Contents	Solution
Main code	Sub code Master/sub 1/sub 2		
F3	01/02/03	Reverse connection of high/low pressure gas pipe and suction gas pipe of Branch Selector unit.	Check connection of high/low pressure gas pipe and suction gas pipe.
	01/03/05	Discharge temperature too high (R2T/R21T/R22T): • Stop valves are closed. • Refrigerant shortage.	• Open stop valves. • Check refrigerant amount and recharge.
	20/21/22	Compressor casing temperature too high (R14T): • Stop valves are closed. • Refrigerant shortage.	• Open stop valves. • Check refrigerant amount and recharge.
F5	02	• Stop valves are closed. • Refrigerant overcharge.	• Open stop valves. • Check refrigerant amount and recharge.
F9	01	Electronic expansion valve malfunction (Branch Selector units).	Check connection on printed circuit board or actuator.
	02		
	05		
H3	01/02/03	Temperature sensor malfunction (R1T)-A1P (X18A)	Check connection on printed circuit board or actuator.
J3	16/22/28	Temperature sensor malfunction (R2T, R21T)-A1P (X19A)	Check connection on printed circuit board or actuator.
	17/23/29	Temperature sensor malfunction (R2T, R21T)-A1P (X19A)	Check connection on printed circuit board or actuator.
	18/24/30	Temperature sensor malfunction (R22T)-A1P (X19A)	Check connection on printed circuit board or actuator.
	19/25/31	Temperature sensor malfunction (R22T)-A1P (X19A)	Check connection on printed circuit board or actuator.
	47/49/51	Temperature sensor malfunction (R14T)-A1P (X19A)	Check connection on printed circuit board or actuator.
	48/50/52	Temperature sensor malfunction (R14T)-A1P (X19A)	Check connection on printed circuit board or actuator.
J5	01/03/05	Temperature sensor malfunction (R12T)-A8P (X15A)	Check connection on printed circuit board or actuator.
	18/19/20	Temperature sensor malfunction (R10T)-A1P (X29A)	Check connection on printed circuit board or actuator.
J6	01/02/03	Temperature sensor malfunction (R11T)-A8P (X15A)	Check connection on printed circuit board or actuator.
	08/09/10	Temperature sensor malfunction (R8T)-A1P (X29A)	Check connection on printed circuit board or actuator.
	11/12/13	Temperature sensor malfunction (R9T)-A1P (X29A)	Check connection on printed circuit board or actuator.
J7	01/02/03	Temperature sensor malfunction (R3T)-A1P (X30A)	Check connection on printed circuit board or actuator.
	06/07/08	Temperature sensor malfunction (R7T)-A1P (X30A)	Check connection on printed circuit board or actuator.
J8	01/02/03	Temperature sensor malfunction (R4T)-A1P (X30A)	Check connection on printed circuit board or actuator.
	08/09/10	Temperature sensor malfunction (R5T)-A1P (X30A)	Check connection on printed circuit board or actuator.
	11/12/13	Temperature sensor malfunction (R15T)-A8P (X15A)	Check connection on printed circuit board or actuator.
J9	01/02/03	Temperature sensor malfunction (R6T)-A1P (X30A)	Check connection on printed circuit board or actuator.
	11/12/13	Temperature sensor malfunction (R13T)-A8P (X17A)	Check connection on printed circuit board or actuator.
J9	06/08/10	High pressure sensor malfunction: open circuit (S1NPH)-A1P (X32A)	Check connection on printed circuit board or actuator.
	07/09/11	High pressure sensor malfunction: short circuit (S1NPH)-A1P (X32A)	Check connection on printed circuit board or actuator.

Malfunction code		Contents	Solution
Main code	Sub code Master/sub 1/sub 2		
U1	06/08/10	Low pressure sensor malfunction: open circuit (S1NPL)-A1P (X31A)	Check connection on printed circuit board or actuator.
	07/09/11	Low pressure sensor malfunction: short circuit (S1NPL)-A1P (X31A)	Check connection on printed circuit board or actuator.
U2	14/15/16	Transmission trouble. A3P (X6A)-A1P (X20A)	Check connection.
	19/20/21	Transmission trouble. A4P (X3A)-A3P (X41A) : REYQ72 A7P (X3A)-A6P (X41A) : REYQ96-168	Check connection.
	24/25/26	Transmission trouble. A4P (X3A)-A7P (X4A) : REYQ96-168	Check connection.
	30/31/32	Transmission trouble. A6P (X6A)-A3P (X41A, X61A) : REYQ96-168	Check connection.
	33/34/35	Transmission trouble. A8P (X2A)-A1P (X20A)	Check connection.
P1	01/02/03	Unbalanced power supply voltage.	Check if power supply is within the range.
	07/08/09		
U1	01/05/07	<ul style="list-style-type: none"> Reversed power supply phase. Printed circuit board malfunction. A12P-A1P (X36A) : REYQ72/144/168TYDN 	<ul style="list-style-type: none"> Correct phase order. Check connection. Check fuse.
	04/06/08	Reversed power supply phase.	Correct phase order.
U2	01/08/11	Voltage power shortage or open power supply phase.	<ul style="list-style-type: none"> Check if power supply is within the range. Correct phase order.
	22/25/28		
	02/09/12	Reversed or open power supply phase.	<ul style="list-style-type: none"> Check if power supply is within the range. Correct phase order.
	23/26/29		
U3	03	System test run not yet executed (system operation not possible).	Execute system test run.
	04	An error occurred during the test run.	Check the piping and re-execute the test run.
	05	Test run aborted.	Re-execute the test run.
	06		
	07	Test run aborted due to communication issues.	Check the communication wires and re-execute the test run.
	08		
U4	01	Faulty wiring to Q1/Q2 or indoor- outdoor.	Connect transmission wiring of Branch Selector units and indoor units to "TO IN/D UNIT (F1, F2)" and transmission wiring of other outdoor units to "TO OUT/D UNIT (F1, F2)".
	03	Malfunction of connected indoor unit.	Check the malfunction code of indoor unit and resolve it.
U7	01	Faulty wiring to Q1/Q2 or indoor- outdoor.	Connect transmission wiring of Branch Selector units and indoor units to "TO IN/D UNIT (F1, F2)" and transmission wiring of other outdoor units to "TO OUT/D UNIT (F1, F2)".
	02		
	11	<ul style="list-style-type: none"> Too many indoor units are connected to F1/F2 line. Faulty wiring between units. 	<ul style="list-style-type: none"> Check indoor unit amount and total capacity connected. Check connection.
U9	01	<ul style="list-style-type: none"> System mismatch. Wrong type of indoor units combined (R407C, Mini-split, etc). Indoor unit malfunction. 	Check if other indoor units have malfunction and confirm indoor unit mix is allowed.

Malfunction code		Contents	Solution
Main code	Sub code Master/sub 1/sub 2		
U3	03	Connection malfunction over indoor units or type mismatch (R407C, Mini-split, etc).	Check if other indoor units have malfunction and confirm indoor unit mix is allowed.
	18		
	20	Wrong combination (different series (e.g. RXYQ and REYQ), or different type (e.g. P type and T type)).	Correct the units combination.
	27	Assembly defect of indoor, Branch Selector and outdoor units (e.g. different models, number of units or part numbers, or different series are mixed).	<ul style="list-style-type: none"> Check and modify the number of indoor units that are connected. Check the type of refrigerant for indoor and outdoor units, and replace them with adaptable indoor/outdoor units in the case of inconsistency.
	28	Different type of Branch Selector units are combined in the system. Combination of T type (BSQ-TVJ, BS-Q54TVJ) and P type (BSVQ-PVJU, BSV-Q36PVJU) cause error.	Configure the system with only T type Branch Selector units.
	31	Wrong combination of outdoor units.	Correct the units combination.
	49		
53	<ul style="list-style-type: none"> Defect of Branch Selector units connecting position or abnormality due to wiring error. Abnormality of Branch Selector units DIP switches settings. 	<ul style="list-style-type: none"> Check that the wiring connection are correct, referring to the wiring diagram for Branch Selector units, and correct if there are any errors. Check that the DIP switches settings are correct, referring to the installation manual enclosed in Branch Selector units package, or to the "Service precautions" plate attached to the control box cover, and correct if there are any errors. 	
U4	01	Auto address malfunction (inconsistency)	Check if transmission wired unit amount matches with powered unit amount (by monitor mode) or wait till initialization is finished.
U5	01	Auto address malfunction (inconsistency)	Check if transmission wired unit amount matches with powered unit amount (by monitor mode) or wait till initialization is finished.
	05	Stop valves closed.	Open stop valves.

Malfunction code		Contents	Solution
Main code			
<i>Auto charging related</i>			
P2		Unusual low pressure on suction line.	Close valve A immediately. Push BS1 to reset. Check following items before retrying automatic charging procedures: <ul style="list-style-type: none"> Check if gas pipe stop valves are opened correctly. Check if the valve of the refrigerant cylinder is opened. Check if air inlet and outlet of indoor units are not obstructed.
P8		Indoor unit freeze-up prevention.	Close valve A immediately. Push BS1 to reset. Retry automatic charging procedures.
P9		Automatic charging nearly finished.	Prepare for automatic charging stopping.
P3		Automatic charging finished.	Finish automatic charging mode.

16. Operation of the unit

Once the units are installed and test operation of outdoor units, Branch Selector units and indoor units are finished, the operation of the system can start.

For operating the indoor units, the user interface of the indoor units should be switched ON. Refer to the indoor unit operation manual for more details.

17. Maintenance and service

17.1. Maintenance introduction

In order to ensure optimal operation of the unit, a number of checks and inspections should be carried out on the unit at regular intervals, preferably yearly.

This maintenance shall be carried out by the installer or service agent.

17.2. Service precautions

⚠ DANGER: DO NOT TOUCH PIPING AND INTERNAL PARTS —
See Safety considerations on page i.

⚠ CAUTION

When performing service to inverter equipment:

- 1 Do not open the control box cover for 10 minutes after the power supply is turned off.
- 2 Measure the voltage between terminals on the terminal block for power supply with a tester and confirm that the power supply is turn off. In addition, measure points as shown in the figure below, with a tester and confirm that the voltage of the capacitor in the main circuit is less than 50 V DC.

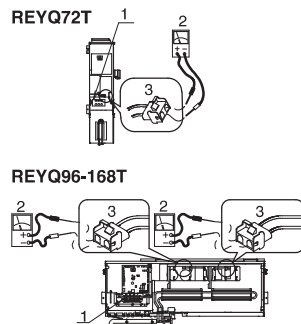

- 1 Terminal block for power supply
- 2 Tester
- 3 White connector

- 3 To prevent damaging the printed circuit board, touch a noncoated metal part to eliminate static electricity before pulling out or plugging in connectors.
- 4 Pull out junction connectors X1A, X2A (X3A, X4A) for the fan motors in the outdoor unit before starting service operation on the inverter equipment. Be careful not to touch the live parts. (If a fan rotates due to strong wind, it may store electricity in the capacitor or in the main circuit and cause electric shock.)
- 5 After the service is finished, plug the junction connector back in. Otherwise the malfunction code E7 will be displayed on the user interface or on the outdoor unit segment display and normal operation will not be performed.

For details refer to the wiring diagram labelled on the back of the control box cover.

Pay attention to the fan. It is dangerous to inspect the unit while the fan is running. Make sure to turn off the main switch and to remove the fuses from the control circuit located in the outdoor unit.

⚠ NOTE

Play it safe. For protection of the printed circuit board, touch the control box casing by hand in order to eliminate static electricity from your body before performing service.

17.3. Service mode operation

Refrigerant recovery operation/vacuumping operation is possible by applying setting [2-21]. Refer to 13.2. Operating the push buttons and DIP switches on the printed circuit board on page 24 for details how to set mode 2.

When vacuuming/recovery mode is used, check very carefully what should be vacuumed/recovered before starting. See installation manual of the indoor unit for more information about vacuuming and recovery.

17.3.1. Vacuuming method

- 1 When the unit is at standstill, set the unit in [2-21]=1.
- 2 When confirmed, the indoor units, the Branch Selector units and outdoor unit expansion valves will fully open. At that moment the segment display indication=t.01 and the user interface of all indoor units indicate TEST (test operation) and (external control) and the operation will be prohibited.
- 3 Evacuate the system with a vacuum pump.
- 4 Press BS3 to stop vacuuming mode.

17.3.2. Refrigerant recovery operation method

This should be done by a refrigerant reclaimier. Follow the same procedure as for vacuuming method.

18. Caution for refrigerant leaks

18.1. Introduction

The installer and system specialist shall secure safety against leakage according to local regulations or standards. The following standards may be applicable if local regulations are not available.

The VRV System, like other air conditioning systems, uses R410A as refrigerant. R410A itself is an entirely safe non-toxic, non-combustible refrigerant. Nevertheless care must be taken to ensure that air conditioning facilities are installed in a room that is sufficiently large. This assures that the maximum concentration level of refrigerant gas is not exceeded, in the unlikely event of major leak in the system and this in accordance to the local applicable regulations and standards.

Maximum concentration level

The maximum charge of refrigerant and the calculation of the maximum concentration of refrigerant is directly related to the humanly occupied space in to which it could leak.

The unit of measurement of the concentration is lbs./ft.³ (kg/m³) (the weight in lbs. (kg) of the refrigerant gas in 1 ft.³ (1 m³) volume of the occupied space).

Compliance to the local applicable regulations and standards for the maximum allowable concentration level is required.

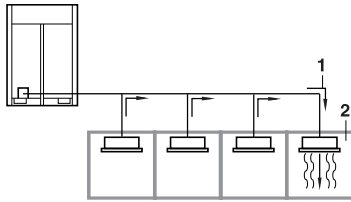

- 1 Direction of the refrigerant flow.
- 2 Room where refrigerant leak has occurred (outflow of all the refrigerant from the system).

Pay special attention to places, such as basements etc., where refrigerant can stay, since refrigerant is heavier than air.

Procedure for checking maximum concentration

Check the maximum concentration level in accordance with steps 1 to 2 below and take whatever action is necessary to comply.

- 1 Calculate the amount of refrigerant (lbs. (kg)) charged to each system separately.

<p>Amount of refrigerant in a single unit system (amount of refrigerant with which the system is charged before leav- ing the factory)</p>	+	<p>Additional charging amount (amount of re- frigerant added locally in accordance with the length or diameter of the refrigerant piping)</p>	=	<p>Total amount of refrigerant (lbs. (kg)) in the system</p>
--	---	---	---	--

NOTE
Where a single refrigerant facility is divided into 2 entirely independent refrigerant systems then use the amount of refrigerant with which each separate system is charged.

- 2 Follow local code requirements (ASHRAE-15 2007 & ASHRAE-34 2007).

19. Disposal requirements

Dismantling of the unit, treatment of the refrigerant, of oil and of other parts must be done in accordance with relevant local and national legislation.

Appendix 2 Installation Manual REYQ-PC

1. Installation Manual	i
------------------------------	---

1. Installation Manual

REYQ72-120PCYD REYQ72-144PCTJ

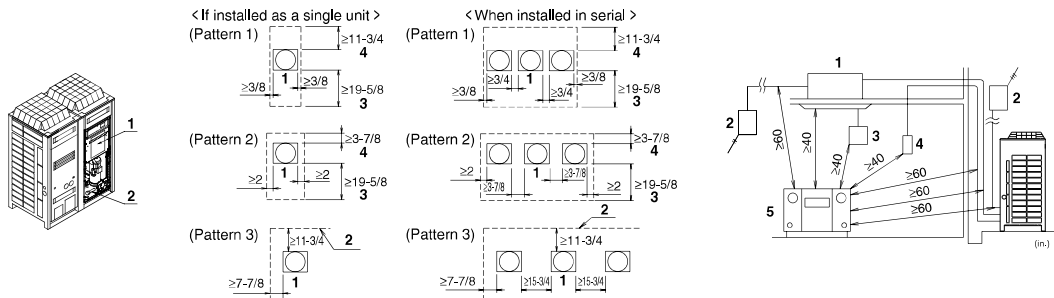

figure 1

figure 2

figure 3

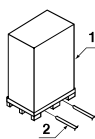

figure 4

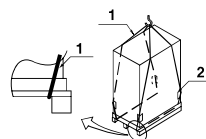

figure 5

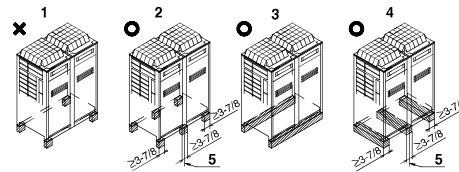

figure 6

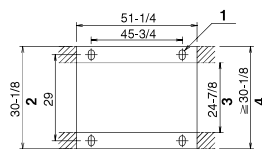

figure 7

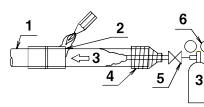

figure 8

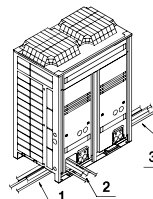

figure 9

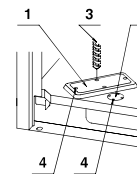

figure 10

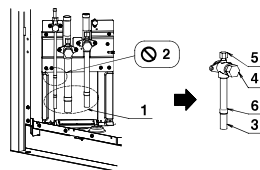

figure 11

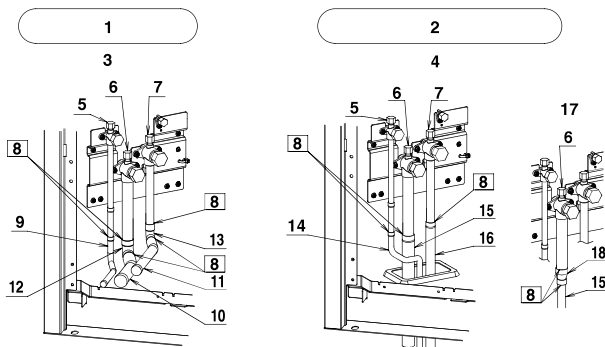

figure 12

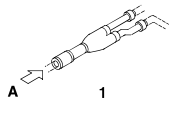

figure 13

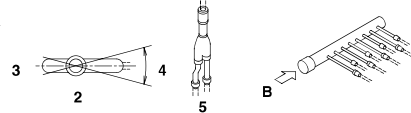

figure 14

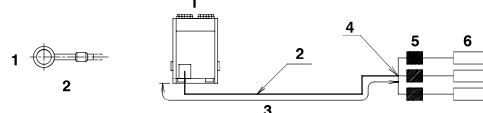

figure 15

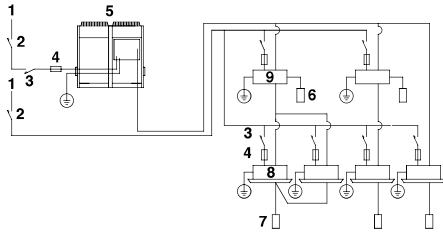

figure 16

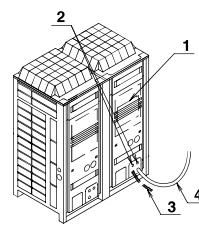

figure 17-1

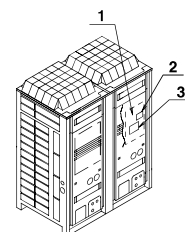

figure 17-2

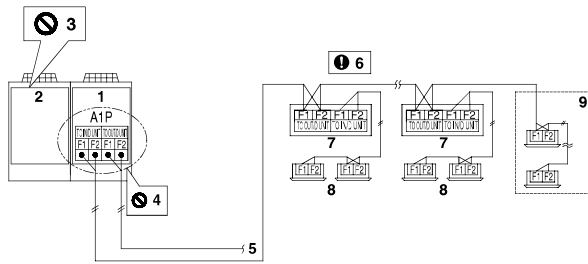

figure 18

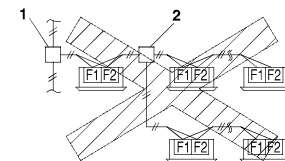

figure 19

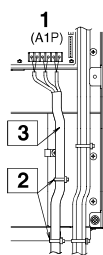

figure 20

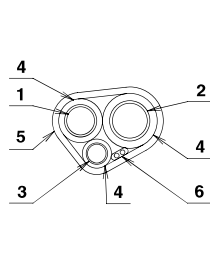

figure 21

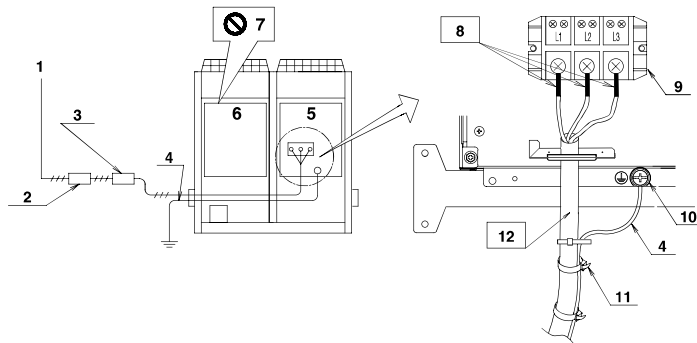

figure 22

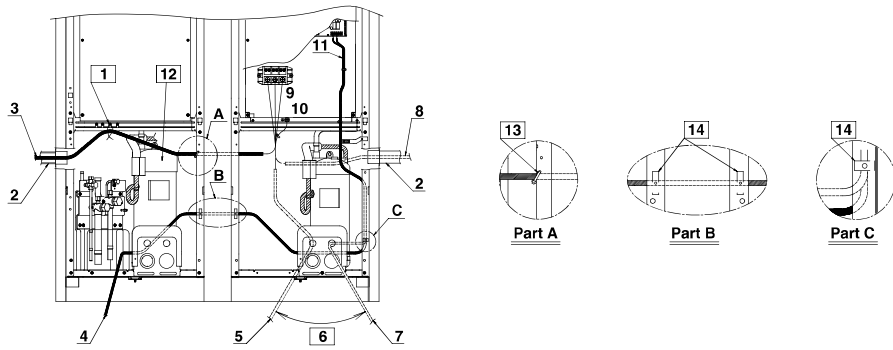

figure 23

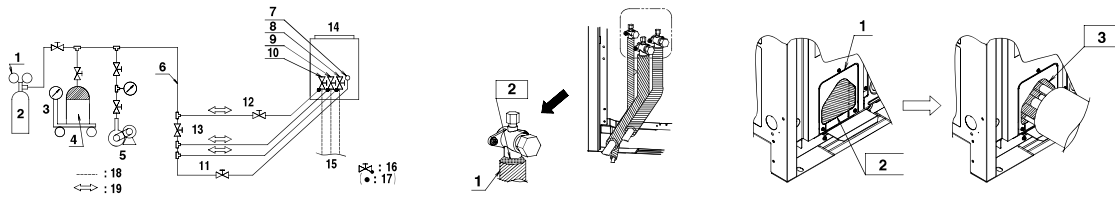

figure 24

figure 25

figure 26

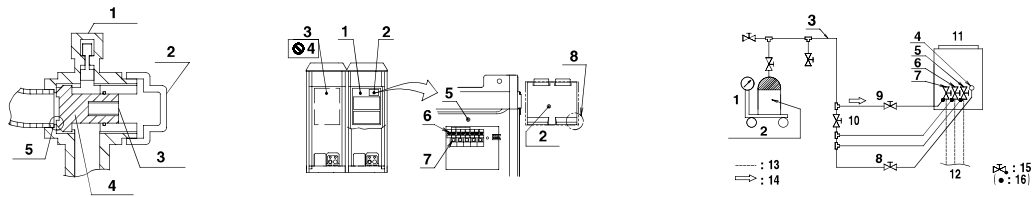

figure 27

figure 28

figure 29

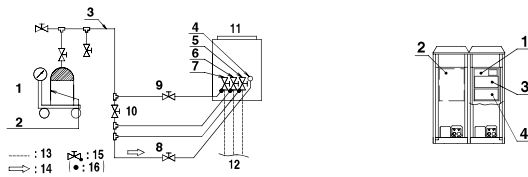

figure 30

figure 31



REYQ72PCYD REYQ72PCTJ
 REYQ96PCYD REYQ96PCTJ
 REYQ120PCYD REYQ120PCTJ
 REYQ144PCTJ

VRVIII System air conditioner

Installation manual

CONTENTS

1. FIRST OF ALL.....1
 1-1. Safety considerations.....1
 1-2. Special notice of product.....2
 1-3. Disposal requirements.....3
 2. INTRODUCTION.....3
 2-1. Combination.....3
 2-2. Standard supplied accessories.....3
 2-3. Option accessory.....3
 2-4. Technical and Electrical specifications.....3
 2-5. Main components.....3
 3. SELECTION OF LOCATION.....3
 4. INSPECTING AND HANDLING THE UNIT.....4
 5. PLACING THE UNIT.....4
 6. REFRIGERANT PIPING.....4
 6-1. Selection of piping material and Refrigerant branching kit.....4
 6-2. Protection against contamination when installing pipes.....5
 6-3. Pipe connection.....5
 6-4. Connecting the refrigerant piping.....5
 6-5. Example of connection.....6
 7. FIELD WIRING.....9
 7-1. Power circuit, safety device and cable requirements.....9
 7-2. Wiring Connection Example for Whole System.....9
 7-3. Leading wire Procedure.....9
 7-4. Transmission Wiring Connection Procedure.....10
 7-5. Power Wiring Connection Procedure.....10
 7-6. Procedure for Wiring Inside Units.....11
 8. AIR TIGHT TEST AND VACUUM DRYING.....11
 9. PIPE INSULATION.....12
 10. CHECKING OF DEVICE AND INSTALLATION CONDITIONS.....12
 11. ADDITIONAL REFRIGERANT CHARGE AND CHECK OPERATION.....12
 11-1. Before working.....12
 11-2. Procedure of Adding Refrigerant charging and check operation.....13
 12. ONSITE SETTINGS.....16
 12-1. Energy saving and optimum operation.....16
 13. TEST RUN.....19
 13-1. Before test run.....19
 13-2. Test Run.....19
 13-3. Checks After Test Run.....19
 14. CAUTION FOR REFRIGERANT LEAKS.....20

1. FIRST OF ALL

• This document is an installation manual for the Daikin REYQ-P Series VRV Inverter. Before installing the unit, read this manual thoroughly, and following the instructions contained in it. After installation, do a test run to make sure the unit runs properly, and then explain how to operate and take care of the unit to the customer, using the operation manual. Lastly, make sure the customer keeps this manual, along with the operation manual, in a safe place.

1-1 Safety considerations

Read these "SAFETY CONSIDERATIONS for Installation" carefully before installing air conditioning equipment. After completing the installation, make sure that the unit operates properly during the startup operation. Instruct the customer on how to operate and maintain the unit. Inform customers that they should store this Installation Manual with the Operation Manual for future reference. Always use a licensed installer or contractor to install this product. Improper installation can result in water or refrigerant leakage, electrical shock, fire, or explosion.

Meanings of **DANGER**, **WARNING**, **CAUTION**, and **NOTE** Symbols:

- DANGER** Indicates an imminently hazardous situation which, if not avoided, will result in death or serious injury.
- WARNING** Indicates a potentially hazardous situation which, if not avoided, could result in death or serious injury.
- CAUTION**..... Indicates a potentially hazardous situation which, if not avoided, may result in minor or moderate injury. It may also be used to alert against unsafe practices.
- NOTE**..... Indicates situations that may result in equipment or property-damage accidents only.

DANGER

- Refrigerant gas is heavier than air and replaces oxygen. A massive leak can lead to oxygen depletion, especially in basements, and an asphyxiation hazard could occur leading to serious injury or death.
- Do not ground units to water pipes, gas pipes, telephone wires, or lightning rods as incomplete grounding can cause a severe shock hazard resulting in severe injury or death. Additionally, grounding to gas pipes could cause a gas leak and potential explosion causing severe injury or death.
- If refrigerant gas leaks during installation, ventilate the area immediately. Refrigerant gas may produce toxic gas if it comes in contact with fire. Exposure to this gas could cause severe injury or death.
- After completing the installation work, check that the refrigerant gas does not leak throughout the system.
- Do not install unit in an area where flammable materials are present due to risk of explosions that can cause serious injury or death.
- Safely dispose all packing and transportation materials in accordance with federal/state/local laws or ordinances. Packing materials such as nails and other metal or wood parts, including plastic packing materials used for transportation may cause injuries or death by suffocation.

WARNING

- Only qualified personnel must carry out the installation work. Installation must be done in accordance with this installation manual. Improper installation may result in water leakage, electric shock, or fire.
- When installing the unit in a small room, take measures to keep the refrigerant concentration from exceeding allowable safety limits. Excessive refrigerant leaks, in the event of an accident in a closed ambient space, can lead to oxygen deficiency.
- Use only specified accessories and parts for installation work. Failure to use specified parts may result in water leakage, electric shocks, fire, or the unit falling.
- Install the air conditioner on a foundation strong enough that it can withstand the weight of the unit. A foundation of insufficient strength may result in the unit falling and causing injuries.
- Take into account strong winds, typhoons, or earthquakes when installing. Improper installation may result in the unit falling and causing accidents.
- Make sure that a separate power supply circuit is provided for this unit and that all electrical work is carried out by qualified personnel according to local, state, and national regulations. An insufficient power supply capacity or improper electrical construction may lead to electric shocks or fire.

- Make sure that all wiring is secured, that specified wires are used, and that no external forces act on the terminal connections or wires. Improper connections or installation may result in fire.
- When wiring, position the wires so that the electrical components box lid can be securely fastened. Improper positioning of the electrical components box lid may result in electric shocks, fire, or the terminals overheating.
- Before touching electrical parts, turn off the unit.
- Be sure to install a ground fault circuit interrupter if one is not already available. This helps prevent electrical shocks or fire.
- Securely fasten the outdoor unit terminal cover (panel). If the terminal cover/panel is not installed properly, dust or water may enter the outdoor unit causing fire or electric shock.
- When installing or relocating the system, keep the refrigerant circuit free from substances other than the specified refrigerant (R410A) such as air. Any presence of air or other foreign substance in the refrigerant circuit can cause an abnormal pressure rise or rupture, resulting in injury.
- Do not change the setting of the protection devices. If the pressure switch, thermal switch, or other protection device is shorted and operated forcibly, or parts other than those specified by Daikin are used, fire or explosion may occur.

⚠ CAUTION

- Do not touch the switch with wet fingers. Touching a switch with wet fingers can cause electric shock.
- Do not allow children to play on or around the unit to prevent injury.
- Do not touch the refrigerant pipes during and immediately after operation as the refrigerant pipes may be hot or cold, depending on the condition of the refrigerant flowing through the refrigerant piping, compressor, and other refrigerant cycle parts. Your hands may suffer burns or frostbite if you touch the refrigerant pipes. To avoid injury, give the pipes time to return to normal temperature or, if you must touch them, be sure to wear proper gloves.
- Heat exchanger fins are sharp enough to cut. To avoid injury wear glove or cover the fins when working around them.
- Install drain piping to proper drainage. Improper drain piping may result in water leakage and property damage.
- Insulate piping to prevent condensation.
- Be careful when transporting the product.
- Do not turn off the power immediately after stopping operation. Always wait for at least 5 minutes before turning off the power. Otherwise, water leakage may occur.
- Do not use a charging cylinder. Using a charging cylinder may cause the refrigerant to deteriorate.
- Refrigerant R410A in the system must be kept clean, dry, and tight.
 - (a) Clean and Dry – Foreign materials (including mineral oils such as SUNISO oil or moisture) should be prevented from getting into the system.
 - (b) Tight – R410A does not contain any chlorine, does not destroy the ozone layer, and does not reduce the earth's protection against harmful ultraviolet radiation. R410A can contribute to the greenhouse effect if it is released. Therefore take proper measures to check for the tightness of the refrigerant piping installation. Read the chapter Refrigerant Piping and follow the procedures.
- Since R410A is a blend, the required additional refrigerant must be charged in its liquid state. If the refrigerant is charged in a state of gas, its composition can change and the system will not work properly.
- The indoor unit is for R410A. See the catalog for indoor models that can be connected. Normal operation is not possible when connected to other units.
- Remote controller (wireless kit) transmitting distance can be shorter than expected in rooms with electronic fluorescent lamps (inverter or rapid start types). Install the indoor unit far away from fluorescent lamps as much as possible.

- Indoor units are for indoor installation only. Outdoor units can be installed either outdoors or indoors.
- Do not install the air conditioner in the following locations:
 - (a) Where a mineral oil mist or oil spray or vapor is produced, for example, in a kitchen. Plastic parts may deteriorate and fall off or result in water leakage.
 - (b) Where corrosive gas, such as sulfurous acid gas, is produced. Corroding copper pipes or soldered parts may result in refrigerant leakage.
 - (c) Near machinery emitting electromagnetic waves. Electromagnetic waves may disturb the operation of the control system and cause the unit to malfunction.
 - (d) Where flammable gas may leak, where there is carbon fiber, or ignitable dust suspension in the air, or where volatile flammables such as thinner or gasoline are handled. Operating the unit in such conditions can cause a fire.
- Take adequate measures to prevent the outdoor unit from being used as a shelter by small animals. Small animals making contact with electrical parts can cause malfunctions, smoke, or fire. Instruct the customer to keep the area around the unit clean.

⚠ NOTE

- Install the power supply and control wires for the indoor and outdoor units at least 3.5 feet away from televisions or radios to prevent image interference or noise. Depending on the radio waves, a distance of 3.5 feet may not be sufficient to eliminate the noise.
- Dismantling the unit, treatment of the refrigerant, oil and additional parts must be done in accordance with the relevant local, state, and national regulations.
- Do not use the following tools that are used with conventional refrigerants: gauge manifold, charge hose, gas leak detector, reverse flow check valve, refrigerant charge base, vacuum gauge, or refrigerant recovery equipment.
- If the conventional refrigerant and refrigerator oil are mixed in R410A, the refrigerant may deteriorate.
- This air conditioner is an appliance that should not be accessible to the general public.
- The wall thickness of field-installed pipes should be selected in accordance with the relevant local, state, and national regulations.

Codes and Regulations

This product is designed and manufactured to comply with national codes. Installation in accordance with such codes and/or prevailing local codes/regulations is the responsibility of the installer. The manufacturer assumes no responsibility for equipment installed in violation of any codes or regulations. Rated performance is achieved after charge adjustment (sub-cooling of 14±1°F (8±0.5°C)) and 72 hours of operation.

1-2 Special notice of product

[CLASSIFICATION]

This air conditioner comes under the term "appliances not accessible to the general public".

[REFRIGERANT]

VRVIII System use R410A refrigerant.

- The refrigerant R410A requires strict cautions for keeping the system clean, dry and tight. Read the chapter "REFRIGERANT PIPING" carefully and follow these procedures correctly.
 - A. Clean and dry
Foreign materials (including mineral oils such as SUNISO oil or moisture) should be prevented from getting mixed into the system.
 - B. Tight
Take care to keep the system tight when installing. R410A does not contain any chlorine, does not destroy the ozone layer, and does not reduce the earth's protection against harmful ultraviolet radiation. R410A can contribute slightly to the greenhouse effect if it is released.

- Since R410A is a mixed refrigerant, the required additional refrigerant must be charged in its liquid state. If the refrigerant is charged in a state of gas, its composition changes and the system will not work properly.

[DESIGN PRESSURE]

Since design pressure is 478 psi, the wall thickness of pipes should be more carefully selected in accordance with the relevant local and national regulations.

1-3 Disposal requirements

Dismantling of the unit, treatment of the refrigerant, oil and eventual other parts, should be done in accordance with the relevant local and national regulations.

2. INTRODUCTION

- REYQ-P series are designed for outdoor installation and used for cooling and heating applications.
- The BS units that combined with REYQ-P system for changing the refrigerant flow to indoor units are T type (BSQ-TVJ, BS-Q54TVJ) or P type (BSVQ-PVJU, BSV-Q36PVJU) only. Combination with T type and P type cause malfunction.
- The indoor units that combined with REYQ-P system for air conditioning are Daikin VRV series indoor units that compatible with R410A. To learn which indoor units are compatible with R410A, refer to the product catalogs. To combine with other refrigerant indoor unit will cause malfunction.

2-1 Combination

- The indoor units can be installed in the following range.
 (Outdoor unit) (Total capacity index of indoor units)
 REYQ72PCYD/PCTJ36 ~ 93
 REYQ96PCYD/PCTJ48 ~ 124
 REYQ120PCYD/PCTJ60 ~ 156
 REYQ144PCTJ72 ~ 187
- If the total capacity of the connected indoor units exceeds the capacity of the outdoor unit, cooling and heating performance may drop when running the indoor units. See the capacity table in the Engineering Data Book for details.

2-2 Standard supplied accessories

Confirm the following accessories are included. The storage location of the accessories is shown in figure 1.

! NOTE

Do not throw away any of the accessories until installation is complete. They are needed for installation work.

Name	Clamp(1)	Clamp(2)	Vinyl tube	Conduit mounting plate	Manuals, etc.
Quantity	9 pcs.	3 pcs.	4 pcs.	2 pcs.	2 pcs.
Shape					1 pc. each • Operation manual • Installation manual • "REQUEST FOR THE INDICATION" label (Installation records)

Name	Liquid side accessory pipe (1)	Liquid side accessory pipe (2)	Suction gas side accessory pipe (1)	Suction gas side accessory pipe (2)
Quantity	72P type 96P type 120P/144P type	1 pc.	1 pc.	1 pc.
Shape				
			φ7/8 φ7/8 φ1-1/8	φ3/4 φ7/8 φ1-1/8

Name	HP / LP gas side accessory pipe (1)	HP / LP gas side accessory pipe (2)	L type accessory joint (1)	L type accessory joint (2)	accessory joint (2)
Quantity	72P type 96P type 120P/144P type	1 pc.	1 pc.	1 pc.	1 pc.
Shape					
	φ5/8 φ3/4 φ7/8	φ5/8 φ3/4 φ7/8	φ1	φ3/4	

(Refer to figure 1)

1. Clamps, Manuals, etc.
2. Accessory pipes

2-3 Option accessory

To install the outdoor units, the following optional parts are also required. To select an optimum kit, refer to "6. REFRIGERANT PIPING".

• **Refrigerant branching kit**

	for 3 piping			
REFNET header	—	KHRP25M33H9	KHRP25M72H9	KHRP25M73HU9
REFNET joint	KHRP25M22T	KHRP25M33T	KHRP25M72TU9	KHRP25M73TU9

	for 2 piping		
REFNET header	KHRP26M22H9	KHRP26M33H9	KHRP26M72H9
REFNET joint	KHRP26M22T	KHRP26M33T	KHRP26M72TU9

Make sure that any separately purchased accessories are designed for use with R410A.

2-4 Technical and Electrical specifications

Refer to the Engineering Data Book for the complete list of specifications.

2-5 Main components

For main components and function of the main components, refer to the Engineering Data Book.

3. SELECTION OF LOCATION

Select a location for installation that meets the following conditions and get the customer's permission.

1. Select the location of the unit in such a way that neither the discharged air nor the sound generated by the unit disturb anyone.
2. The foundation is strong enough to support the weight of the unit and the floor is flat to prevent vibration and noise generation.
3. The piping length between the outdoor unit and the indoor unit may not exceed the allowable piping length. (Refer to "6. REFRIGERANT PIPING")
4. Locations where the unit's suction vent and outlet vent do not generally face the wind. Wind blowing directly into the suction or outlet vents will interfere with the unit's operation. If necessary, install some kind of obstruction to block the wind.
5. The space around the unit is adequate for servicing and the minimum space for air inlet and air outlet is available. (See the "Installation Space Examples" for the minimum space requirements.)

Installation Space Examples

- The installation space requirement shown in figure 2 is a reference for cooling operation when the outdoor temperature is 95°F. If the design outdoor temperature exceeds 95°F or the heat load exceeds maximum capacity in all the outdoor unit, take an even large space on the intake shown in figure 2.
- During installation, install the units using the most appropriate of the patterns shown in figure 2 for the location in question, taking into consideration human traffic and wind.
- If the number of units installed is more than that shown in the pattern in figure 2, install the units so there are no short circuits.
- As regards space in front of the unit, consider the space needed for the local refrigerant piping when installing the units.
- If the work conditions in figure 2 do not apply, contact your dealer or Daikin directly.

(Refer to figure 2)

1. Front side
2. No limit to wall height
3. Service space of front side
4. Service space of suction side

For Patterns 1 and 2 in figure 2 :

- Wall height for front side – no higher than 59 in.
- Wall height on the suction side – no higher than 19-5/8 in.
- Wall height for sides – no limit.

- If the height is exceeded the above, calculate h1 and h2 shown in the figure below, and add h2/2 to the service space of front side and h1/2 to the service space of suction side.

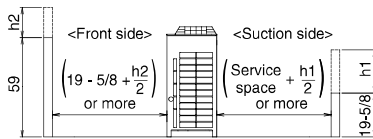

⚠ DANGER

- Do not install unit in an area where flammable materials are present due to risk of explosion resulting in serious injury or death.
- Refrigerant gas in heavier air and replaces oxygen. A massive leak could lead to oxygen depletion, especially in basements, and an asphyxiation hazard could occur leading to serious injury or death. Refer to the chapter "CAUTION FOR REFRIGERANT LEAKS".

⚠ NOTE

1. An inverter air conditioner may cause electronic noise generated from AM broadcasting. Examine where to install the main air conditioner and electric wires, keeping proper distances away from stereo equipment, personal computers, etc. Particularly for locations with weak reception, ensure there is a distance of at least 10 ft for indoor remote controllers, place power wiring and transmission wiring in conduits, and ground the conduits.

(Refer to figure 3)

1. Indoor unit
 2. Branch switch, overcurrent breaker
 3. Remote controller
 4. COOL/HEAT selector
 5. Personal computer or radio
2. When installing in locations where there is heavy snowfall, implement the following snow measures.
 - Ensure the base is high enough that intakes are not clogged by snow.
 - Remove the rear intake grille to prevent snow from accumulating on the fins.

4. INSPECTING AND HANDLING THE UNIT

- At delivery, the package should be checked and any damage should be reported immediately to the carrier claims agent.
- When handling the unit, take into account the following :

1. Fragile, handle the unit with care.
 1. Keep the unit upright in order to avoid compressor damage.
2. Decide on the transportation route.
3. If a forklift is to be used, pass the forklift arms through the large openings on the bottom of the unit. **(Refer to figure 4)**
4. If hanging the unit, use a cloth sling to prevent damaging the unit. Keeping the following points in mind, hang the unit following the procedure shown in figure 5.
 - Use a sling sufficiently strong to hold the mass of the unit.
 - Use 2 belts of at least 27 ft long.
 - Place extra cloth or boards in the locations where the casing comes in contact with the sling to prevent damage.
 - Hoist the unit making sure it is being lifted at its center of gravity.
5. After installation, remove the transportation clasp (yellow) attached to the large openings. **(Refer to figure 4)**

(Refer to figure 4)

1. Packaging material
2. Forklift

(Refer to figure 5)

1. Belt sling
2. Wear plate

5. PLACING THE UNIT

- Make sure the unit is installed level on a sufficiently strong base to prevent vibration and noise. **(Refer to figure 6)**
- The base should support the unit with the extent larger than hatched area in figure 7. If protective rubber is to be attached, attach it to the whole face of the base.
- The height of the base should be at least 5-7/8 in. from the floor.
- Secure the unit to its base using foundation bolts. (Use four commercially available M12-type foundation bolts, nuts, and washers.)
- The foundation bolts should be inserted 13/16 in.

(Refer to figure 6)

1. Independent base (four corner type)
2. Independent base (with center support type)
3. Beam base (Horizontal)
4. Beam base (Vertical)
5. Center of the product



(Refer to figure 7)

1. Foundation bolt point (ø9/16 in. dia. : 4 positions)
2. (Depth of product)
3. (Inner dimension of the base)
4. (Outer dimension of the base)

⚠ NOTE

- There are restrictions on the refrigerant pipe connecting order between outdoor unit in the case of the multi system. See "2-1 Combination" for detail.
- When installing on a roof, make sure the roof floor is strong enough and be sure to water-proof all work.
- Make sure the area around the machine drains properly by setting up drainage grooves around the foundation. Drain water is sometimes discharged from the outdoor unit when it is running.
- For anti-corrosion type, use nuts with resin washers. If the paint on nut connections comes off, the anti-corrosion effect may decrease.

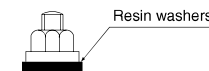

6. REFRIGERANT PIPING

⚠ NOTE

- All field piping must be installed by a licensed refrigeration technician and must comply with relevant local and national regulations.
- After piping work is complete, do not under any circumstances open the shutoff valve until "7. FIELD WIRING" and "10. CHECKING OF DEVICE AND INSTALLATION CONDITIONS" are complete.
- Do not use flux when brazing the refrigerant piping. Use the phosphor copper brazing filler metal (B-Cu93P-710/795 : ISO 3677) which does not require flux. (Flux has extremely negative effect on refrigerant piping systems. For instance, if the chlorine based flux is used, it will cause pipe corrosion or, in particular, if the flux contains fluorine, it will damage the refrigerant oil.)

6-1 Selection of piping material and Refrigerant branching kit

- Use only pipes which are clean inside and outside and which do not accumulate harmful sulfur, oxidants, dirt, cutting oils, moisture, or other contamination. (Foreign materials inside pipes including oils for fabrication must be 0.14 gr/10 ft or less.)
- Use the following items for the refrigerant piping.
 - Material** : Jointless phosphor-deoxidized copper pipe
 - Size** : See "6-5 Example of connection" to determine the correct size.
 - Thickness** : Select a thickness for the refrigerant piping which complies with national and local laws.
- For piping work, follow the maximum tolerated length, difference in height, and length after a branch indicated in the "6-5 Example of connection".

- Outdoor unit multi connection piping kit and refrigerant branching kit (sold separately) are needed for connection of piping between outdoor units (in case of multi system) and piping branches. Use only separately sold items selected specifically according to the outdoor unit multi connection piping kit, the refrigerant branching kit selection in the "6-5 Example of connection".

6-2 Protection against contamination when installing pipes

Protect the piping to prevent moisture, dirt, dust, etc. from entering the piping.

Place	Installation period	Protection method
Outdoor	More than a month	Pinch the pipe
	Less than a month	Pinch or tape the pipe
Indoor	Regardless of the period	

NOTE

Exercise special caution to prevent dirt or dust when passing piping through holes in walls and when passing pipe edges to the exterior.

6-3 Pipe connection

- Be sure to perform nitrogen permutation or nitrogen blow when brazing. (Refer to figure 8)

Brazing without performing nitrogen permutation or nitrogen blow into the piping will create large quantities of oxidized film on the inside of the pipes, adversely affecting valves and compressors in the refrigerating system and preventing normal operation.

(Refer to figure 8)

- Refrigerant pipe
 - Location to be brazed
 - Nitrogen
 - Taping
 - Handy valve
 - Regulator
- The pressure regulator for the nitrogen released when doing the brazing should be set to about 2.9 psi (Enough to feel a slight breeze on your cheek).

NOTE

Do not use anti-oxidants when brazing the pipe joints. Residue can clog pipes and break equipment.

6-4 Connecting the refrigerant piping

1. Direction to bring out the pipes

The local inter unit piping can be connected either forward or to the sides (taken out through the bottom) as shown in the figure 9.

When passing out through the bottom, use the knock hole in the bottom frame.

(Refer to figure 9)

- Left-side connection
- Front connection
- Right-side connection

Precautions when knocking out knock holes

- Open knock hole (large, small) in the base frame by drilling the 4 concave around it with a ϕ -1/4"-bit. (Refer to figure 10)

(Refer to figure 10)

- Knock hole (large : for liquid pipe, suction gas pipe and HP/LP gas pipe)
 - Knock hole (small : for equalizer pipe)
 - Drill
 - Concave section (4 points)
- Be sure to avoid damaging the casing.
 - After knocking out the holes, we recommend you remove any burrs and paint them using the repair paint to prevent rusting.
 - When passing electrical wiring through the knock holes, protect the wiring with a conduit or bushings, making sure not to damage the wiring.
- 2. Removing Pinch Piping**
- When connecting refrigerant piping to an outdoor unit, remove the pinch piping using the procedure in the figure 11. (Refer to figure 11)

- About handling of shutoff valves, refer to [Shutoff valve operation procedure] in "11-1 Before working".

CAUTION

After removing the gas, remove the pinch piping. Any gas remaining inside may blow off the pinch piping when you dissolve the brazing, causing damage.

(Refer to figure 11)

- Pinch piping (3 pieces)
 - Do not remove the relay piping.
 - Pinch piping
 - Procedure 1 : Confirm the shutoff valve is closed.
 - Procedure 2 : Connect a charge hose to the service port of shutoff valve and remove the gas in the pinch piping.
 - Procedure 3 : After removing the gas in the pinch piping, dissolve the brazing using a burner and remove the pinch piping.
- 3. Connecting refrigerant piping to outdoor units**
- Figure 12 shows the example of connecting refrigerant piping to outdoor units.
 - The local inter unit piping next accessory pipes are field supplied.

(Refer to figure 12)

- When connected to the front
- When connected at lateral side (bottom)
- Remove the shutoff valve cover to connect.
- Remove the knock hole on the bottom frame and route the piping under the bottom frame.
- Liquid pipe shutoff valve
- Suction gas pipe shutoff valve
- HP/LP gas pipe shutoff valve
- Brazing
- Liquid side accessory pipe (1)
- Suction gas side accessory pipe (1)
- HP/LP gas side accessory pipe (1)
- L type accessory joint (1)
- L type accessory joint (2)
- Liquid side accessory pipe (2)
- Suction gas side accessory pipe (2)
- HP/LP gas side accessory pipe (2)
- In case of 72P type use the Accessory joint for connecting the Suction gas side accessory pipe (2) to Suction gas side shutoff valve.
- Accessory joint

NOTE

- Make sure the onsite piping does not come into contact with other piping or the bottom frame or side panels of the unit.

4. Branching the refrigerant piping

Heed the restrictions below when installing the refrigerant branching kit and read the installation instruction manual with the kit. (Improper installation could lead to malfunctioning or breakdown of the outdoor unit.)

<REFNET joint>

Install the REFNET joint so it splits horizontally or vertically.

(Refer to figure 13)

- Horizontal
- A-arrow view
- Horizontal surface
- $\pm 30^\circ$ or less
- Vertical

<REFNET header>

Install the REFNET header so it splits horizontally.

(Refer to figure 14)

- Horizontal surface
- B-arrow view

6-5 Example of connection

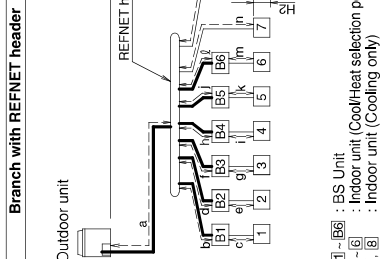
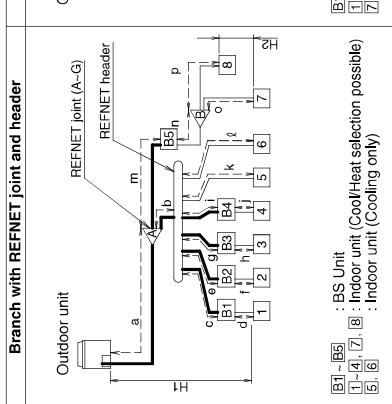
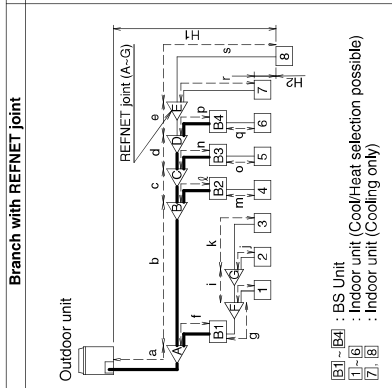
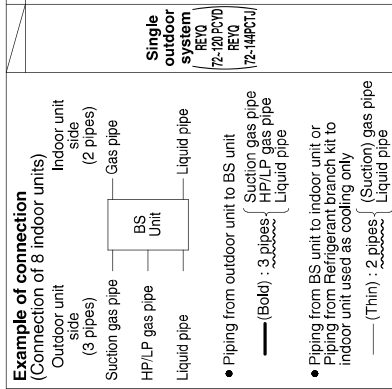
<p>Example of connection (Connection of 8 indoor units)</p> 	<p>Single outdoor system 72-120 (R/V) REVQ 72-140 (R/V) REVQ 72-140 (R/V) REVQ</p>	<p>Branch with REFNET joint</p> 	<p>Branch with REFNET joint and header</p> 	<p>Branch with REFNET header</p> 
<p>Outdoor unit side (3 pipes) Suction gas pipe HP/LP gas pipe Liquid pipe</p>	<p>BS Unit Indoor unit (Cool-Heat selection possible) Indoor unit (Cooling only)</p>	<p>BS Unit Indoor unit (Cool-Heat selection possible) Indoor unit (Cooling only)</p>	<p>BS Unit Indoor unit (Cool-Heat selection possible) Indoor unit (Cooling only)</p>	<p>BS Unit Indoor unit (Cool-Heat selection possible) Indoor unit (Cooling only)</p>
<p>Maximum allowable length</p>	<p>Actual pipe length</p>	<p>Pipe length between outdoor unit and indoor unit ≤ 540 ft Example [6]: a + b + c + d + e ≤ 540 ft</p>	<p>Pipe length between outdoor unit and indoor unit ≤ 540 ft Example [6]: a + b + l ≤ 540 ft, [8]: a + m + n + p ≤ 540 ft Example [8]: a + o ≤ 540 ft</p>	<p>Pipe length between outdoor unit and indoor unit ≤ 540 ft Example [6]: a + b + d + e ≤ 540 ft Equivalent pipe length between outdoor unit and indoor unit ≤ 620 ft (Note 1) (Assume equivalent pipe length of REFNET joint to be 1.6ft, that of REFNET header to be 3.3ft, that of BS(V)Q36,60 is 13ft and BS(V)Q96 is 19ft, that of BS(Y)4,6Q is 19ft and BS6, 10, 12Q is 33ft for calculation purposes.) Total piping length from outdoor unit to all indoor unit ≤ 3280 ft</p>
<p>Allowable height difference</p>	<p>Difference in height</p>	<p>Difference in height Difference in height between outdoor unit and indoor unit (H1) ≤ 164 ft (Max 130 ft if the outdoor unit is below)</p>	<p>Difference in height Difference in height between outdoor unit and indoor unit (H2) ≤ 49 ft</p>	<p>Difference in height Difference in height between outdoor unit and indoor unit (H1) ≤ 164 ft (Max 130 ft if the outdoor unit is below)</p>
<p>Allowable length after the branch</p>	<p>Actual pipe length</p>	<p>Actual pipe length from first refrigerant branch kit (either REFNET joint or REFNET header) to indoor unit ≤ 130 ft (Note 2) Example [6]: b + c + d + e + s ≤ 130 ft</p>	<p>Actual pipe length from first refrigerant branch kit (either REFNET joint or REFNET header) to indoor unit ≤ 130 ft (Note 2) Example [6]: b + l ≤ 130 ft, [8]: m + n + p ≤ 130 ft</p>	<p>Actual pipe length from first refrigerant branch kit (either REFNET joint or REFNET header) to indoor unit ≤ 130 ft (Note 2) Example [8]: o ≤ 130 ft</p>

For Note 1 and 2, refer to Installation Manual page 8.

Refrigerant branch kit selection

1 Refrigerant branch kits can only be used with R410A.

How to select the REFNET joint
 • When using REFNET joint at the first branch counted from the outdoor unit side, choose from the following table in accordance with the outdoor unit capacity type. (Example : REFNET joint A)

Outdoor unit capacity type	Refrigerant branch kit name
REYQ72 - 96P type	KHRP25M33T
REYQ120 - 144P type	KHRP25M72TU9

• Choose the REFNET joints other than the first branch from the following table in accordance with the total capacity index of all the indoor units connected below the REFNET joint.

Indoor unit total capacity index	Refrigerant branch kit name
x < 72	KHRP25M22T
72 ≤ x < 111	KHRP25M33T
111 ≤ x	KHRP25M72TU9

Example REFNET joint C : Indoor units [5] + [6] + [7] + [8] Example REFNET joint B : Indoor units [7] + [8]

Pipe size selection

⚠ The thickness and material shall be selected in accordance with local code.

For an outdoor unit installation, make the settings in accordance with the following figure.

Outdoor unit

How to select the REFNET header
 • Choose from the following table in accordance with the total capacity index of all the indoor units connected below the REFNET header.

Indoor unit total capacity index	Refrigerant branch kit name
x < 72	KHRP25M33H9
72 ≤ x < 111	KHRP26M33H9
111 ≤ x	KHRP25M72H9

Example REFNET header : Indoor units [1] + [2] + [3] + [4] + [5] + [6] Indoor units [1] + [2] + [3] + [4] + [5] + [6] + [7] + [8]

Piping between outdoor unit (C2 and refrigerant branch kit (part A))
 • Choose from the following table in accordance with the outdoor units system capacity type. (unit : in.)

Outdoor unit capacity type	Piping size (O. D.)	
	Suction gas pipe	Liquid pipe
REYQ72P type	ø3/4	ø5/8
REYQ96P type	ø7/8	ø3/4
REYQ120P type	ø1-1/8	ø7/8
REYQ144P type		ø1/2

Piping between indoor units connected downstream
 Example for indoor units connected downstream

Piping between refrigerant branch kits
 Piping between BS unit and refrigerant branch kit
 Piping between BS unit and refrigerant branch kit

• Choose from the following table in accordance with the total capacity type of all the indoor units connected downstream.

*1 Connection piping must not exceed the refrigerant Piping size between outdoor unit and refrigerant branch kit (part A).
 *2 When selecting 2 pipes (in gas pipe and liquid pipe), use Suction gas pipe column for gas pipe and Liquid pipe column for liquid pipe. (unit : in.)

Indoor capacity index	Piping size (O. D.)	
	Suction gas pipe	Liquid pipe
x < 54	ø5/8	ø1/2
54 ≤ x < 72	ø3/4	ø5/8
72 ≤ x < 111	ø7/8	ø3/4
111 ≤ x < 162	ø1-1/8	ø1-1/8
162 ≤ x		ø5/8

Piping between refrigerant branch kit, BS unit and indoor unit.
 • Match to the size of the connection piping on the indoor unit. (unit : in.)

Indoor unit capacity type	Piping size (O. D.)	
	gas pipe	Liquid pipe
07 - 09 - 12 - 18	ø1/2	ø1/4
24 - 30 - 36 - 48 - 54	ø5/8	
72	ø3/4	ø3/8
96	ø7/8	

How to calculate the additional refrigerant to be charged [HEAT RECOVER SYSTEM]

Additional refrigerant to be charged : R(lb)
(R should be rounded (off in units of 0.1 lb.)

$$R = \left[\left(\frac{\text{Total length (ft) of liquid piping (size at } \phi 5/8)}{\times 0.121} \right) + \left(\frac{\text{Total length (ft) of liquid piping (size at } \phi 3/8)}{\times 0.040} \right) + \left(\frac{\text{Total length (ft) of liquid piping (size at } \phi 1/2)}{\times 0.081} \right) + \left(\frac{\text{Total length (ft) of liquid piping (size at } \phi 1/4)}{\times 0.015} \right) \right] \times 1.02 + \left[\frac{\text{HEAT RECOVER SYSTEM MODEL NAME REYQ72 - 144P Type}}{\text{THE AMOUNT OF REFRIGERANT 7.9 lb}} \right] + \left[\frac{\text{REFRIGERANT AMOUNT FOR EXCEEDING CONNECTION CAPACITY OF INDOOR UNIT MODEL NAME REYQ72 - 144P Type}}{\text{CAPACITY MORE THAN 100% 1.1 lb}} \right] + \left[\frac{\text{REFRIGERANT AMOUNT FOR EXCEEDING CONNECTION CAPACITY OF INDOOR UNIT MODEL NAME REYQ72 - 144P Type}}{\text{CAPACITY MORE THAN 120% 1.1 lb}} \right] + \left[\frac{\text{REFRIGERANT AMOUNT FOR EXCEEDING CONNECTION CAPACITY OF INDOOR UNIT MODEL NAME REYQ72 - 144P Type}}{\text{CAPACITY MORE THAN 130% OR LESS 1.1 lb}} \right]$$

Example for refrigerant branch using REFNET joint and REFNET header for systems and each pipe length as shown below.

a : $\phi 3/8 \times 15\text{ft.}$	e : $\phi 3/8 \times 5\text{ft.}$	i : $\phi 3/8 \times 5\text{ft.}$	m : $\phi 1/2 \times 10\text{ft.}$
b : $\phi 3/8 \times 10\text{ft.}$	f : $\phi 3/8 \times 5\text{ft.}$	j : $\phi 3/8 \times 5\text{ft.}$	n : $\phi 3/8 \times 5\text{ft.}$
c : $\phi 3/8 \times 5\text{ft.}$	g : $\phi 3/8 \times 5\text{ft.}$	k : $\phi 3/8 \times 10\text{ft.}$	o : $\phi 1/4 \times 5\text{ft.}$
d : $\phi 3/8 \times 5\text{ft.}$	h : $\phi 3/8 \times 5\text{ft.}$	l : $\phi 3/8 \times 10\text{ft.}$	p : $\phi 1/2 \times 5\text{ft.}$

$$R = \left(\left[15 \times 0.081 \right] + \left[90 \times 0.040 \right] + \left[5 \times 0.015 \right] \right) \times 1.02 + \left[\frac{7.9}{1} \right] + \left[\frac{1.1}{1} \right] = 13.988 \rightarrow \boxed{14.0 \text{ lb}}$$

Round off in units of 0.1 lb.

Note 1. When the equivalent pipe length between outdoor and indoor units is 295 ft or more, the size of main pipes on the liquid side (refer to figure 15) must be increased according to the right table (Never increase suction gas pipe and HP/LP gas pipe.) (Refer to figure 15)

1. Outdoor unit
2. Main pipes
3. Increase only liquid pipe size
4. First refrigerant branch kit
5. BS unit
6. Indoor unit

System	Liquid pipe
REYQ72 - 96P type	$\phi 3/8 \rightarrow \phi 1/2$
REYQ120 - 144P type	$\phi 1/2 \rightarrow \phi 5/8$

Note 2. Allowable length after the first refrigerant branch kit to indoor units is 130 ft or less, however it can be extended up to 295 ft if all the following conditions are satisfied. (In case of "Branch with REFNET joint")

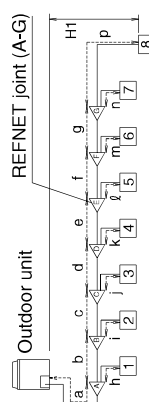
Required Conditions	Example Drawings
1. It is necessary to increase the pipe size between the first branch kit and the final branch kit. (Reducers must be procured on site) However, the pipes that are same pipe size with main pipe must not be increased	Increase the pipe size as follows $\phi 3/8 \rightarrow \phi 1/2$ $\phi 5/8 \rightarrow \phi 3/4$ $\phi 1/2 \rightarrow \phi 5/8$ $\phi 3/4 \rightarrow \phi 7/8$ $\phi 1-1/8 \rightarrow \phi 1-1/4$ $\phi 1-3/8 \rightarrow \phi 1-1/2$ *
2. For calculation of Total extension length, the actual length of above pipes must be doubled. (except main pipe and the pipes that are not increased)	Outdoor unit  REFNET joint (A-G) Indoor units (1 - 8)
3. Indoor unit to the nearest branch kit ≤ 130 ft.	$a + b \times 2 + c \times 2 + d \times 2 + e \times 2 + f \times 2 + g \times 2 + h + i + j + k + l + m + n + p \leq 3280$ ft.
4. The difference between [Outdoor unit to the farthest indoor unit] and [Outdoor unit to the nearest indoor unit] ≤ 130 ft.	$h, i, j, \dots, p \leq 130$ ft. The farthest indoor unit [8] The nearest indoor unit [1] $(a + b + c + d + e + f + g + p) - (a + h) \leq 130$ ft.

*If available on the site, use this size. Otherwise it can not be increased.

7. FIELD WIRING

NOTE

- All field wiring and components must be installed by a licensed electrician and must comply with relevant local and national regulations.
- Be sure to use a dedicated power circuit. Never use a power supply shared by another appliance.
- Never install a phase advancing capacitor. As this unit is equipped with an inverter, installing a phase advancing capacitor will not only deteriorate power factor improvement effect, but also may cause capacitor abnormal heating accident due to high-frequency waves.
- Only proceed with wiring work after blocking off all power.
- Always ground wires in accordance with relevant local and national regulations.
- This machine includes an inverter device. Connect earth and leave charge to eliminate the impact on other devices by reducing noise generated from the inverter device and to prevent leaked current from being charged in the outer hull of the product.
- Do not connect the ground wire to gas pipes, sewage pipes, lightning rods, or telephone ground wires.
Gas pipes : can explode or catch fire if there is a gas leak.
Sewage pipes : no grounding effect is possible if hard plastic piping is used.
Telephone ground wires and lightning rods : dangerous when struck by lightning due to abnormal rise in electrical potential in the grounding.
- Be sure to install an earth leakage circuit breaker.
 This unit uses an inverter, so install the earth leakage circuit breaker that be capable of handling high harmonics in order to prevent malfunctioning of the earth leakage circuit breaker itself.
- Earth leakage circuit breaker which are especially for protecting ground-faults should be used in conjunction with main switch or fuse for use with wiring.
- Electrical wiring must be done in accordance with the wiring diagrams and the description herein.
- Do not operate until refrigerant piping work is completed.
 (If operated before complete the piping work, the compressor may be broken down.)
- Never remove thermistor, sensor or etc. when connecting power wiring and transmission wiring.
 (If operated with thermistor, sensor or etc. removed, the compressor may be broken down.)
- This product have reversed phase protection detector that only works when the power is turned on. If there exists blackout or the power goes on and off which the product is operating, attach a reversed phase protection circuit locally. Running the product in reversed phase may break the compressor and other parts.
- Attach the power wire securely. Introducing power with a missing N-phase or with a mistaken N-phase will break the unit.
- Never connect the power supply in reversed phase.
 The unit can not operate normally in reversed phase.
 If you connect in reversed phase, replace two of the three phases.
- Make sure the electrical unbalance ratio is no greater than 2%. If it is larger than this, the unit's lifespan will be reduced.
 If the ratio exceeds 4%, the unit will shut down and an malfunction code will be displayed on the indoor remote controller.
- Connect the wire securely using designated wire and fix it with attached clamp without applying external pressure on the terminal parts (terminal for power wiring, terminal for transmission wiring and earth terminal).
- If there exists the possibility of reversed phase, lose phase, momentary blackout or the power goes on and off while the product is operating, attach a reversed phase protection circuit locally.
 Running the product in reversed phase may break the compressor and other parts.

7-1 Power circuit, safety device and cable requirements

- A power circuit (see the following table) must be provided for connection of the unit. This circuit must be protected with the required safety devices, i.e. a main switch, a slow blow fuse on each phase and an earth leakage circuit breaker.
- When using residual current operated circuit breakers, be sure to use a high-speed type (0.1 second or less) 200mA rated residual operating current.
- Use copper conductors only.

- Use insulated wire for the power cord.
- Select the power supply cable type and size in accordance with relevant local and national regulations.
- Specifications for local wiring power cord and branch wiring are in compliance with local cord.

	Phase and frequency	Voltage	Minimum circuit amp.	Maximum overcurrent protective device	Transmission line selection
REYQ72PCYD	φ 3, 60Hz	460V	16.0A	20A	AWG18-16
REYQ96PCYD	φ 3, 60Hz	460V	20.4A	25A	AWG18-16
REYQ120PCYD	φ 3, 60Hz	460V	20.5A	30A	AWG18-16

	Phase and frequency	Voltage	Minimum circuit amp.	Maximum overcurrent protective device	Transmission line selection
REYQ72PCTJ	φ 3, 60Hz	208/230V	36.1A	40A	AWG18-16
REYQ96PCTJ	φ 3, 60Hz	208/230V	43.8A	45A	AWG18-16
REYQ120PCTJ	φ 3, 60Hz	208/230V	44.2A	50A	AWG18-16
REYQ144PCTJ	φ 3, 60Hz	208/230V	72.2A	80A	AWG18-16

7-2 Wiring Connection Example for Whole System

(Refer to figure 16)

1. Power supply
2. Main switch
3. Earth leakage circuit breaker
4. Fuse
5. Outdoor unit
6. COOL/HEAT selector
7. Remote controller
8. Indoor unit
9. BS unit

NOTE

- Make sure the weak electric wiring (i.e. for the remote controller, between units, etc.) and the power wiring do not pass near each other, keeping them at least 2 in. apart.
 Proximity may cause electrical interference, malfunctions, and breakage.
- Be sure to connect the power wiring to the power wiring terminal block and secure it as described in "7-5 Power Wiring Connection Procedure".
- Transmission wiring should be secured as described in "7-4 Transmission Wiring Connection Procedure".
- Secure wiring with clamp such as insulation lock ties to avoid contact with piping.
- Shape the wires to prevent the structure such as the electrical components box lid deforming. And close the cover firmly.
- All field wiring is to be procured on site.

7-3 Leading wire Procedure

- The power wiring and ground wiring are passed out from the power wiring hole on the sides, the front (knock hole) or the bottom frame (knock hole).
- The transmission wiring is passed out from the wiring hole (knock hole) on the front of the unit or from a piping hole.

(Refer to figure 17-1)

1. Electric wiring diagram
 Printed on the back of the electrical components box lid.
2. Knockout hole
3. Power line
4. Transmission line

(Refer to figure 17-2)

1. Electrical components box lid
2. Service lid
3. [Service precautions] Label location

- NOTE**
- Open the knock holes with a hammer or the like.
 - After knocking out the holes, we recommend you remove any burrs and paint them using the repair paint to prevent rusting. (Refer to figure 17-1, 2)
 - When passing wiring through the knock holes, remove burrs around the knock holes and protect the wiring with protective tape. (Refer to figure 17-1, 2)
 - If small animals might enter the unit, block off any gaps (hatching parts in figure 17-1, 2) with material (field supply).

7-4 Transmission Wiring Connection Procedure

- Referring to figure 18 connect the transmission wiring between outdoor unit and indoor unit, outdoor unit and outdoor unit of other system, outdoor unit and outdoor unit of same system.

(Refer to figure 18)

1. Electrical components box (1)
2. Electrical components box (2)
3. Do not open the electrical components box (2) lid. (There are no work when installation)
4. Never connect the power wire.
5. To outdoor unit of other system
6. Use duplex wires (No polarity)
7. BS unit
8. Indoor unit
9. Indoor unit (Cooling only)

- NOTE**
- Do not connect the power wiring to terminals for the transmission wiring. Doing so would destroy the entire system.
 - When connecting wires to the terminal block on the PC-board, too much heat or tightening could damage the PC-board. Attach with care. See the table below for the tightening torque of the transmission wiring terminals.

Screw size	Tightening torque (ft · lbf)
M3.5 (A1P)	0.59 ~ 0.71

- Transmission wiring (About the symbol ① ~ ②, see figure 18) should be done within the following limitations. If they are exceeded, transmission problems may occur.

- ① Between outdoor unit and BS (or indoor) unit
- Between BS unit and indoor unit
- Between outdoor unit and outdoor unit of other systems
- | | |
|--------------------------|-----------|
| Max. wiring length | : 3280 ft |
| Max. total wiring length | : 6560 ft |
| Max. no. of branches | : 16 |

[Note]
No branch is allowed after branch (See figure 19)

Max. no. of outdoor units of other system that can be connected : 10

(Refer to figure 19)

1. Branch
2. Branch after branch

- ② Between outdoor unit and outdoor unit of same system
- | | |
|--------------------|----------|
| Max. wiring length | : 100 ft |
|--------------------|----------|

- The transmission wiring inside the electrical components box should be secured using the clamp (1) as shown in figure 20.

(Refer to figure 20)

1. In the electrical components box
2. Retain to the electrical components box with the accessory clamp (1).
3. Vinyl tube (accessory)

- Outside the units, the transmission wiring must be finished simultaneously with the local refrigerant piping, and wound with tape (field supply) as shown in figure 21.

(Refer to figure 21)

1. Suction gas pipe
2. HP/LP gas pipe
3. Liquid pipe
4. Insulation material

5. Finishing tape
 6. Transmission wiring
- Wiring to other systems should be connected to terminals F1 and F2 (TO OUT/D UNIT) on the PC-board of the electrical components box(1).

7-5 Power Wiring Connection Procedure

- Be sure to connect the power supply wiring to the power supply terminal block and hold it in place using the included clamp as shown in the figure 22.
- The L1, L2, L3 and N phases of the power wiring should be secured separately to the hook using the included clamp (1).
- The ground wiring should be bound to the power wiring using the included clamp (1) to prevent outside force from being applied to the terminal area.

(Refer to figure 22)

1. Power supply (MODEL PCYD:3-460V 60Hz) (MODEL PCTJ:3-208/230V 60Hz)
2. Earth leakage circuit breaker
3. Branch switch, Overcurrent breaker
4. Ground wire
5. Electrical components box (1)
6. Electrical components box (2)
7. Do not open the electrical components box (2) lid. (There are no work when installation)
8. Attach insulation sleeves
9. Power supply terminal block
10. Ground terminal
11. Clamp (1) (accessory)
12. Vinyl tube (accessory)

- CAUTION**
- Be sure to use crimp-style terminal with insulating sleeves for connections. (See the figure below.)

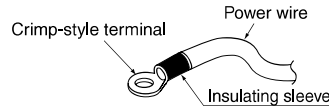

- For wiring, use the designated power wire and connect firmly, then secure to prevent outside pressure being exerted on the terminal board.
- Use an appropriate screwdriver for tightening the terminal screws. A screwdriver with a small head will strip the head and make proper tightening impossible.
- Over-tightening the terminal screws may break them. See the following table for the tightening torque of the terminal screws.

Screw size	Tightening torque (ft · lbf)
M8 Power terminal, ground terminal	4.06 ~ 5.38

- When pulling the ground wire out, wire it so that it comes through the cut section of the cup washer. (See the figure below.) An improper ground connection may prevent a good ground from being achieved.

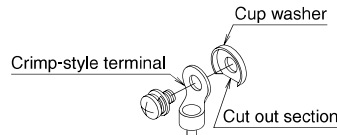

- When two wires are connected to a single terminal, connect them so that the rear sides of the crimp contacts face each other. Also, make sure the thinner wire is on top, securing the two wires simultaneously to the resin hook using the included clamp (1).

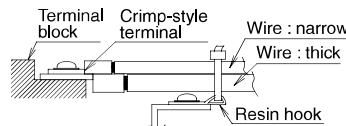

7-6 Procedure for Wiring Inside Units

- Referring to figure 23, secure and wire the power and transmission wiring using the included clamp (1), (2), and (3).
- Wire so that the ground wiring does not come into contact with the compressor lead wiring. If they touch, this may have an adverse effect on other devices.
- The transmission wiring must be at least 2 in. away from the power wiring.
- Make sure all wiring do not contact to the pipes (hatching parts in the figure 23).

(Refer to figure 23)

1. Secure to the hook of column support using the accessory clamp (1).
2. Electric conduit
3. When routing out the power/ground wires from the left side.
4. When routing out the transmission wiring from the opening for piping.
5. When routing out the power/ground wires from the front.
6. Clear over 2 in.
7. When routing out the transmission wiring from the knockout hole.
8. When routing out the power/ground wires from the right side.
9. Power wiring
10. Ground wire
11. Transmission wiring
12. When wiring, exercise sufficient caution not to detach the acoustic insulators from the compressor.
13. Secure to the back side of the support beam using the accessory clamp (1).
14. Retain to the back of the column support with the accessory clamp (2).

Precautions when knocking out knockout holes

- To punch out a knockout hole, hit it with a hammer.
- Open an appropriate hole as needed.
- After knocking out the holes trim off the burr, then we recommend you to paint the edges and areas around the edges using the repair paint to prevent rusting.
- Power line : Open a knockout hole as shown at left and connect it using a conduit.
- Transmission line : Connect it using a conduit in the knockout hole on the right.

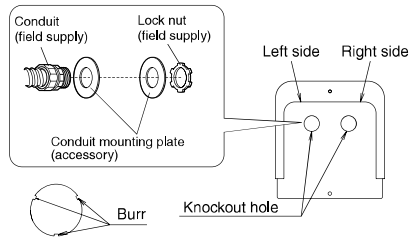

NOTE

- After wiring work is completed, check to make sure there are no loose connections among the electrical parts in the electrical components box.

8. AIR TIGHT TEST AND VACUUM DRYING

- After finished piping work, carry out air tight test and vacuum drying.

NOTE

- Always use nitrogen gas for the airtightness test.
- Absolutely do not open the shutoff valve until the main power circuit insulation measurement has been completed. (measuring after the shutoff valve is opened will cause the insulation value to drop.)

<Needed tools>

Gauge manifold Charge hose valve	<ul style="list-style-type: none"> • To prevent entry of any impurities and insure sufficient pressure resistance, always use the special tools dedicated for R410A. • Use charge hose that have pushing stick for connecting to service port of shutoff valves or refrigerant charge port.
Vacuum pump	<ul style="list-style-type: none"> • The vacuum pump for vacuum drying should be able to lower the pressure to -14.6 psi. • Take care the pump oil never flow backward into the refrigerant pipe during the pump stops.

<The system for air tight test and vacuum drying>

- Referring to figure 24, connect a nitrogen tank, refrigerant tank, and a vacuum pump to the outdoor unit. The refrigerant tank and the charge hose connection to refrigerant charge port or the valve A in figure 24 are needed in "11. ADDITIONAL REFRIGERANT CHARGE AND CHECK OPERATION".

(Refer to figure 24)

1. Gauge manifold
2. Nitrogen
3. Measuring device
4. R410A tank (with siphon)
5. Vacuum pump
6. Charge hose
7. Refrigerant charge port
8. HP/LP gas pipe shutoff valve
9. Suction gas pipe shutoff valve
10. Liquid pipe shutoff valve
11. Valve A
12. Valve B
13. Valve C
14. Outdoor unit
15. To BS (or indoor) unit
16. Shutoff valve
17. Service port
18. Field piping
19. Gas flow

NOTE

- The air-tightness test and vacuum drying should be done using the service ports of equalizer pipe, HP/LP gas pipe, suction gas pipe and liquid pipe shutoff valve. See the [R410A] Label attached to the front plate of the outdoor unit for details on the location of the service port (see figure at right)
- See [Shutoff valve operation procedure] in "11-1 Before working" for details on handling the shutoff valve.
- The refrigerant charge port is connected to unit pipe. When shipped, the unit contains the refrigerant, so use caution when attaching the charge hose.

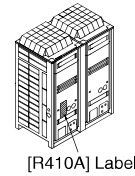

<Air tight test>

Pressurize the liquid pipe, suction gas pipe, HP/LP gas pipe and equalizer pipe from the service ports of each shutoff valve to 550 psi (do not pressurize more than 550 psi). If the pressure does not drop within 24 hours, the system passes the test. If there is a pressure drop, check for leaks, make repairs and perform the airtight test again.

<Vacuum drying>

Evacuate the system from the liquid pipe, suction gas pipe, HP/LP gas pipe and equalizer pipe shutoff valve service ports by using a vacuum pump for more than 2 hours and bring the system to -14.6 psi or less. After keeping the system under that condition for more than 1 hour, check if the vacuum gauge rises or not. If it rises, the system may either contain moisture inside or have leaks.

NOTE

If moisture might enter the piping, follow below. (I.e., if doing work during the rainy season, if the actual work takes long enough that condensation may form on the inside of the pipes, if rain might enter the pipes during work, etc.) After evacuating the system for 2 hours, pressurize the system to 7.25 psi (vacuum break) with nitrogen gas and evacuate the system again using the vacuum pump for 1 hour to -14.6 psi or less (vacuum drying). If the system cannot be evacuated to -14.6 psi within 2 hours, repeat the operation of vacuum break and vacuum drying. Then, after leaving the system in vacuum for 1 hour, confirm that the vacuum gauge does not rise.

9. PIPE INSULATION

- Insulation of pipes should be done after performing "8. AIR TIGHT TEST AND VACUUM DRYING".
- Always insulate the liquid piping, the HP/LP gas piping, the gas piping, and these pipe connections. Failing to insulate the pipes may cause leaking or burns. Especially, be sure to insulate the HP/LP gas piping as withstanding as the suction pipe because the suction gas follows in the HP/LP gas piping when the system is whole cooling mode. And be sure to use the insulation which can withstand such temperatures of 248°F or more for the HP/LP gas piping, the equalizer pipe and the gas piping because the HP/LP gas follows in these pipings.
- Reinforce the insulation on the refrigerant piping according to the installation environment. Condensation might form on the surface of the insulation. Refer to the below.
 - Ambient temperature : 86°F, humidity : 75% to 80% RH : min. thickness : 9/16 in.
 - If the ambient temperature exceeds 86°F and the humidity 80% RH, then the min. thickness is 3/4 in. See the Engineering data book for detail.
- If there is a possibility that condensation on the shutoff valve might drip down into the indoor unit through gaps in the insulation and piping because the outdoor unit is located higher than the indoor unit, etc., this must be prevented by caulking the connections, etc. (Refer to figure 25)
- The piping lead-out hole lid should be attached after opening a knock hole. (Refer to figure 26)
- If small animals and the like might enter the unit through the piping lead-out hole, close the hole with blocking material (procured on site) after completion of "11. ADDITIONAL REFRIGERANT CHARGE AND CHECK OPERATION". (Refer to figure 29)
 - (Refer to figure 25)
 1. Insulation material
 2. Caulking, etc.
 - (Refer to figure 26)
 1. Piping lead-out hole lid
 2. Open a knock hole at "▨▨▨▨".
 3. Block "▨▨▨▨".

NOTE

- After knocking out the holes, we recommend you remove burrs in the knock holes (See figure 26) and paint the edges and areas around the edges using the repair paint.

10. CHECKING OF DEVICE AND INSTALLATION CONDITIONS

Be sure to check the followings.

For those doing electrical work

1. Make sure there is no faulty transmission wiring or loosening of a nut. See "7-4 Transmission Wiring Connection Procedure".
2. Make sure there is no faulty power wiring or loosening of a nut. See "7-5 Power Wiring Connection Procedure".
3. Has the insulation of the main power circuit deteriorated? Measure the insulation and check the insulation is above regular value in accordance with relevant local and national regulations.

For those doing pipe work

1. Make sure piping size is correct. See "6-1 Selection of piping material and Refrigerant branching kit".
2. Make sure insulation work is done. See "9. PIPE INSULATION".
3. Make sure there is no faulty refrigerant piping. See "6. REFRIGERANT PIPING".



11. ADDITIONAL REFRIGERANT CHARGE AND CHECK OPERATION

The outdoor unit is charged with refrigerant when shipped from the factory, but depending on the size and length of the piping when installed, it may require additional charging. For charging the additional refrigerant, follow the procedure in this chapter. And then carry out the check operation.

11-1 Before working

[About the refrigerant tank]

Check whether the tank has a siphon pipe before charging and place the tank so that the refrigerant is charged in liquid form. (See the figure below.)

With siphon pipe		Stand the tank upright and charge. (The siphon pipe goes all the way inside, so the tank does not need to be put upside-down charge in liquid form.)
Other tanks		Stand the tank upside-down and charge.

NOTE

- Always use the proper refrigerant (R410A). If charged with the refrigerant containing an improper material, it may cause an explosion or accident.
- R410A is a mixed refrigerant, so charging it as a gas will cause the refrigerant composition to change, which may prevent normal operation.

[Shutoff valve operation procedure]

When operating the shutoff valve, follow the procedure instructed below.

NOTE

- Do not open the shutoff valve until "10. CHECKING OF DEVICE AND INSTALLATION CONDITIONS" are completed. If the shutoff valve is left open without turning on the power, it may cause refrigerant to buildup in the compressor, leading insulation degradation.
- Be sure to use the correct tools. The shutoff valve is not a back-seat type. If forced it to open, it might break the valve body.
- When using a service port, use the charge hose.
- After tightening the cap, make sure no refrigerant gas is leaking.

Tightening torque

The sizes of the shutoff valves on each model and the tightening torque for each size are listed in the table below.

<Size of Shutoff Valve>

	72P type	96P type	120P/144P type
Liquid pipe shutoff valve	φ3/8		
	The 120P/144P type corresponds to the φ1/2 - diameter onsite piping using the accessory pipe.		
Suction gas shutoff valve	φ1		
	The 72P type corresponds to the φ3/4 - diameter onsite piping using the accessory pipe. The 96P type corresponds to the φ7/8 - diameter onsite piping using the accessory pipe. The 120P/144P type corresponds to the φ1-1/8 - diameter onsite piping using the accessory pipe.		
HP/LP gas shutoff valve	φ3/4		

(Refer to figure 27)

1. Service port
2. Cap
3. Hex holes
4. Shaft (valve body)
5. Seal section

To open

1. Remove the cap and turn the shaft counterclockwise with the hexagon wrench.
2. Turn it until the shaft stops.
3. Make sure to tighten the cap securely.
(For the tightening torque, refer to the item <Tightening Torque>.)

To close

1. Remove the cap and turn the shaft clockwise with the hexagon wrench.
2. Securely tighten the valve until the shaft contacts the main body seal.
3. Make sure to tighten the cap securely.
(For the tightening torque, refer to the item <Tightening Torque>.)

<Tightening torque>

Shutoff valve size	Tightening torque ft · lbf (Turn clockwise to close)			Service port
	Shaft (valve body)		Cap (valve lid)	
φ 3/8	3.98 - 4.87	Hexagonal wrench 4mm	9.95 - 12.17	8.48 - 10.3
φ 1/2	5.97 - 7.30		13.3 - 16.2	
φ 3/4	19.9 - 24.3	Hexagonal wrench 8mm	16.6 - 20.3	
φ 1				

[How to Check How Many Units are Connected]

It is possible to find out how many indoor or outdoor unit in the system are turned on by operating the push button on the PC-board (A1P) of outdoor unit. Follow the procedure below to check how many indoor or outdoor units are turned on.

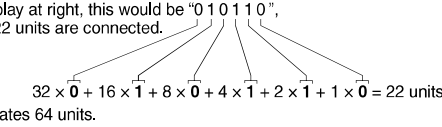
(LED display: ● ...OFF ☉ ...ON ◐ ...Blinking * ...Uncertain)	LED display						
	H1P	H2P	H3P	H4P	H5P	H6P	H7P
(1) Press the MODE button (BS1) once at Setting Mode 1 (H1P : off), and set the MONITOR MODE (H1P : Blinking).	◐	●	●	●	●	●	●
(2) Press the SET button (BS2) the number of times until the LED display matches that at right.	For checking the number of outdoor units : eight times	◐	●	●	☉	●	●
	For checking the number of indoor units : five times	◐	●	●	●	☉	☉
(3) Press the RETURN button (BS3) and read the number of units from the display of H2P through H7P. [Reading Method] The display of H2P through H7P should be read as a binary number, with ◐ standing for "1" and ● standing for "0".	◐	*	*	*	*	*	*
Ex: For the LED display at right, this would be "0 1 0 1 1 0", which would mean 22 units are connected. 	◐	●	◐	●	◐	◐	●
(4) Press the MODE button (BS1) once. This returns to Setting Mode 1 (H1P : OFF, default).	●	●	☉	●	●	●	●

NOTE

Press the "MODE button" (BS1) if you get confused while operating. This returns to **Setting Mode 1** (H1P : OFF, default).

11-2 Procedure of Adding Refrigerant charging and check operation

WARNING Electric Shock Warning

- Make sure to close the electrical components box lid before turning on the power.
- Perform the setting on the PC-board (A1P) of the outdoor unit and check the LED display after the power is on via the inspection door which is in the electrical components box lid.

(Refer to figure 28)

1. Electrical components box (1) (right)

2. Inspection door
3. Electrical components box(2) (left)
4. Do not open the electrical components box (2) (left) lid or that inspection door.
5. Electrical components box (1) (right) lid
6. LED (H1~8P)
7. Push button (BS1~5)
8. Lift the protruding part to open the inspection door.

- Use an insulated rod to operate the push buttons via the electrical components box's inspection door. There is a risk of electric shock if you touch any live parts, since this operation must be performed with the power on.

CAUTION

- Make sure to use the protect tool (protective grooves and goggles) when charging the refrigerant.
- Due to a danger of liquid hammer, the refrigerant must not be charged over the allowable maximum amount when charging the refrigerant.
- Do not perform the refrigerant charging operation under working for the BS and indoor unit.
- When opening the front panel, make sure to take caution to the fan rotation during the working.
After the outdoor unit stops operating, the fan may keep rotation for a while.

NOTE

- If operation is performed within 12 minutes after the BS, indoor and outdoor units are turned on, H2P will be lit on and the compressor will not operate.

Check the LED display indicate as shown below.

H1P	H2P	H3P	H4P	H5P	H6P	H7P
●	●	☼	●	●	●	●

- In order to ensure uniform refrigerant distribution, it may take up to around 10 minutes for the compressor to start up after the unit starting operating. This is not a malfunction.
- The refrigerant charge port is connected to the piping inside the unit. When the unit is shipped from the factory, the unit's internal piping is already charged with refrigerant, so be careful when connecting the charge hose.
- After adding the refrigerant, make sure to close the lid of the refrigerant charging port.
The tightening torque for the lid is 8.48 to 10.3 ft · lbf.
- See [Shutoff valve operation procedure] in chapter 11-1 for details on how to handle shutoff valves.
- When done or when pausing the refrigerant charging operation, close the valve of the refrigerant tank immediately.
The refrigerant charge port of this product have electric expansion valve.
The valve will be closed at end of refrigerant charging. However the valve will be opened on operation after refrigerant charging (check operation, normal operation, etc.).
If the tank is left with the valve open, the amount of refrigerant which is properly charged may be off the point.
- Make sure to perform the check operation after installation. Otherwise, the malfunction code "U3" will be displayed and normal operation cannot be performed.
And the failure of "Check of miswiring" may also cause abnormal operation. Performance may drop due to the failure of "Judgment of piping length".
- Check operation must be performed for each refrigerant piping system. Checking is impossible if plural systems are being done at once.
- The individual problems of indoor units can not be checked. About these problems check by test run after the check operation is completed. (See chapter 13)
- The check operation cannot be performed in recovery or other service modes.

11-2-1 Procedure of Adding Refrigerant charging

1. Make sure the following works are complete in accordance with the installation manual.
 - Piping work
 - Wiring work
 - Air tight test
 - Vacuum drying
 - Installation work for BS, indoor unit
2. Calculate the "additional charging amount" using "How to calculate the additional refrigerant to be charged" in "6-5 Example of connection".
3. Open the valve B (See the figure 29. The valve A,C and the liquid pipe, suction gas pipe, HP/LP gas pipe, equalizer pipe shutoff valves must be left closed), and charge the refrigerant of the "additional charging amount" from the liquid side shutout valve service port.

(Refer to figure 29)

1. Measuring device
2. R410A tank (with siphon)

3. Charge hose
4. Refrigerant charge port
5. HP/LP gas pipe shutoff valve
6. Suction gas shutoff valve
7. Liquid pipe shutoff valve
8. Valve A
9. Valve B
10. Valve C
11. Outdoor unit
12. To BS, indoor unit
13. Field pipings
14. Refrigerant flow
15. Shutoff valve
16. Service port

4. If the "additional charging amount" was charged fully, close the valve B and go to step 6.
If the "additional charging amount" was not charged fully, close the valve B and go to step 5.
5. Perform the refrigerant charging following [Automatic refrigerant charging operation procedure] as shown below. And charge the remaining refrigerant of the "additional charging amount".

NOTE

- For performing the automatic refrigerant charging operation, the push button on the PC-board (A1) of outdoor unit are used. (See figure 28.) And the refrigerant are charged from the refrigerant charge port via the valve A. (See figure 30.) For operating the push button and opening or closing the valves, follow the procedure.
- During Automatic refrigerant charging operation, the system will select charging mode (cooling mode or heating mode) by the temperature condition as follows.

Outdoor temp. : 32°F DB ~ 109°F DB] → Cooling mode
 Indoor temp. : 50°F DB ~ 90°F DB] → Heating mode
 Less than above range → Heating mode

- When charging in cooling mode, the system will stop operation when the required amount of refrigerant is charged.
 During charging in heating mode, a person must manually close valve A and stop operation.
 Beforehand, check the remaining refrigerant that is needed to charge based on the "additional charging amount" in step 2 and the charged amount in step 3.
- The refrigerant will be charged about 66 lb in one hour at outdoor temp. 86°F DB (about 26 lb at outdoor temp. 32°F DB).
 - During Automatic refrigerant charging operation, you can stop the operation forcedly by pushing MODE button (BS1).

(Refer to figure 30)

1. Measuring device
2. R410A tank (with siphon)
3. Charge hose
4. Refrigerant charge port
5. HP/LP gas pipe shutoff valve
6. Suction pipe shutoff valve
7. Liquid pipe shutoff valve
8. Valve A
9. Valve B
10. Valve C
11. Outdoor unit
12. To BS, indoor unit
13. Field pipings
14. Refrigerant flow when charging
15. Shutoff valve
16. Service port

[Automatic refrigerant charging operation procedure]

NOTE

- The marks of LED mean as follows.
● : OFF ☼ : ON ⚡ : Blinking * : OFF, ON or Blinking

- (1) Open the liquid pipe, suction gas pipe and HP/LP gas pipe shutoff valves. (The valve A~C must be closed. See figure 30.)
- (2) Close the electrical components box (1) lid and all front panel except on the electrical components box (1) side. (*1) And turn the power to the outdoor unit and all connected BS, indoor units. (*2)

- After H2P stop blinking (about 12 minutes after turning on the power), check H2P is OFF.
If H2P is ON, check the malfunction code in the remote controller of indoor unit and correct the malfunction in accordance with [Remote controller display malfunction code] in chapter 11-2-2.
- (3) Check the LED. And push the MODE button (BS1) once if the LED displays is not as below.

H1P	H2P	H3P	H4P	H5P	H6P	H7P
●	●	○	●	●	●	●

- (4) Push the TEST button (BS4) once. (The LED displays will change as below.)

H1P	H2P	H3P	H4P	H5P	H6P	H7P
○	○	○	○	○	○	○

- (5) Hold the TEST button (BS4) down for 5 seconds or more. (The LED displays will change as below and fan of outdoor unit will start rotation.)

H1P	H2P	H3P	H4P	H5P	H6P	H7P
●	↻	●	●	●	*	*

- (6) When the compressor start working and the LED displays change any state in below (*3), go to "In case of cooling mode" or "In case of heating mode" in accordance with the LED displays.

H1P	H2P	H3P	H4P	H5P	H6P	H7P
↻	↻	↻	●	○	●	○
↻	↻	●	●	○	●	○

→ Go to "In case of cooling mode"
→ Go to "In case of heating mode"

—In case of cooling mode

- (7) Push the TEST button (BS4) once within 5 minutes after procedure (5) (*4) and close the all front panels (*5).
After that, open the valve A immediately (See figure 30) (*6) and watch the remote controller display of indoor unit.
- (8) If the remote controller display shows "PE" code (*7), ready to close the valve A.
And go to procedure (9).
If the remote controller display shows other code, close the valve A immediately and refer to [Remote controller cooling mode malfunction code]

⚠ Beware the fan running when open the front panel.
The fan may continue rotation after the system stop the operation.

- (9) When the compressor stop working (the fan may continue rotation), close the valve A immediately (*8).
And check the LED displays are as below and the remote controller display shows "P9" code.

H1P	H2P	H3P	H4P	H5P	H6P	H7P
○	↻	↻	○	○	○	○

After checking, push the MODE button (BS1) once and the charging is complete.

—In case of heating mode

- (7) Push the TEST button (BS4) once within 5 minutes after procedure (5) (*4) and close the all front panels.
After that, open the valve A immediately (See figure 30) (*6) and check the charged amount by measuring device.
During operation, if the remote controller display shows "P2" or "P8" code, close the valve A immediately and refer to [Remote controller heating mode malfunction code].

⚠ Beware the fan running when open the front panel.
The fan may continue rotation after the system stop the operation.

- (8) When the required amount of refrigerant is charged, close the valve A (See figure 30) (*8) and push the RETURN button (BS3) once. And then go to procedure (9).
(9) Push the MODE button (BS1) once, and the charging is complete.

Notes (*1)-(*8)

- (*1) Lead the refrigerant charge hose etc. from the pipe intake.
All front panels must be closed at the procedure (7).
(*2) • If you perform the refrigerant charging operation within the refrigerant system that have the power off unit, the operation cannot finish properly.
Check the number of outdoor and indoor units that is powered.
For checking, see [How to check how many units are connected] in chapter 11-1.

- To energize the crankcase heater, make sure to turn on for 6 hours before starting operation.
- (*3) It takes about 2-10 minutes for getting stability of refrigerant state. If the additional refrigerant is little and operation is started before getting stability, the system can not judge the charging amount precisely and it cause over charge.
- (*4) If the TEST button (BS4) is not pushed within 5 minutes, "P2" code will displayed in the remote controller. In this case, refer [Remote controller cooling (or heating) mode malfunction code].
- (*5) If the front panel is opened during the operation, the system cannot operate properly.
- (*6) If you leave the system without connecting the refrigerant tank or opening the valve A for 30 minutes or more, the system stop operation and "P2" code are displayed in remote controller. In this case, refer [Remote controller cooling (or heating) mode malfunction code].
- (*7) Depending on the situation of operation such as the charging amount is little, the "PE" code may not be displayed and the "P9" code may be displayed.
- (*8) Always close the valve A and take the tank off.
The refrigerant charge port of this unit have electric expansion valve and the valve are closed when charging is finished. However, the valve will opened when other operation (Check operation, normal operation, etc.). If you leave the tank connected, the refrigerant will charged and it cause over charge.

[Remote controller cooling mode malfunction code]

Code	The work contents	
PE	Charging is almost finished. Ready to close the valve A.	
PA PH	The refrigerant tank is empty. Close the valve A and replace empty tank to the new tank. After changing the tank, open the valve A again. ⚠ Beware the fan running. The outdoor unit does not stop operation.	
P8	Close the valve A immediately, and restart the operation from procedure (3).	
P2	Operation is interrupted. Close the valve A immediately and check the below items. <ul style="list-style-type: none"> • Check if HP/LP gas pipe, suction gas pipe or liquid pipe shutoff valve is opened. • Check the refrigerant tank is connected and the valve A was opened. • Check if the air inlet and outlet of the indoor unit are not closed by an obstruction. 	After correcting the abnormality, restart the operation from procedure (3).
*	Operation is stopped abnormally. Close the valve A immediately. Confirm the malfunction code and correct the abnormality following the [Remote controller displays malfunction code] in chapter 11-2-2.	
P9	Charging is finished. Close the valve A and take the refrigerant tank off.	

[Remote controller heating mode malfunction code]

Code	The work contents	
P8	Close the valve A immediately and push the TEST button (BS4) once. And restart from procedure (7) of "In case of heating mode".	
P2	Operation is interrupted. Close the valve A immediately and check the below items. <ul style="list-style-type: none"> • Check if HP/LP gas pipe, suction gas pipe or liquid pipe shutoff valve is opened. • Check the refrigerant tank is connected and the valve A was opened. • Check if the air inlet and outlet of the indoor unit are not closed by an obstruction. 	

6. After completing the additional refrigerant charging, record the charging amount on the accessory "REQUEST FOR THE INDICATOR" label (Installation records) and adhere it to the back side of the front panel.

11-2-2 Procedure of check operation

- Check operation perform the following work. Do the check operation following below.
Otherwise, malfunction code "U3" will be displayed in the remote controller and normal operation can not be carried out.
 - Check of shutoff valve opening
 - Check of miswiring
 - Judgment of piping length
 - Check of refrigerant overcharge

NOTE

- Check operation can not carried out at outdoor temp. less than 23°F. Perform the check operation at day or time that outdoor temp. is 23°F or more.

[Check Operation Procedure]

- (1) Close the electrical components box lid and all front panels except as the side of the electrical components box and turn on the power to the outdoor unit and all connected BS, indoor units. (Be sure to turn the power on at least 6 hours before operation in order to have power running to the crank case heater.)
- (2) Make the onsite settings as needed using the push button (BS1-BS5) on the outdoor unit PC-board (A1P) with the power on. (See "12. ONSITE SETTINGS")
- (3) Perform the check operation following the Check Operation Method of the [Service Precautions] label (lower) on the electrical components box lid. (See figure 31) The system operation for about 40-60 minutes and automatically stops the check operation.
If the malfunction code is not displayed in the remote controller after the system stop, check operation is completed. Normal operation will be possible after 5 minutes. If the malfunction code is displayed in the remote controller, correct the malfunction following [Remote controller displays malfunction code] and perform the check operation again.

(Refer to figure 31)

1. Electrical components box(1) lid
2. Electrical components box(2) lid
3. [Service Precaution] label (upper)
4. [Service Precaution] label (lower)

NOTE

For interrupting the check operation, push RETURN button (BS3).

[Remote controller displays malfunction code]

Malfunction code	Installation error	Remedial action
E3, E4 F3, F6 UF	The shutoff valve of the outdoor unit is left closed.	Open the shutoff valve.
U1	The phases of the power to the outdoor unit is reversed.	Exchange two of the three phases (L1, L2, L3) to make a proper connection.
U1 U4 LC	No power is supplied to an outdoor, BS or indoor unit (including phase interruption).	Make sure the power source wire is properly connected to the outdoor, BS or indoor unit and revise if necessary.
U7 UA	<ul style="list-style-type: none"> • A model which cannot be connected in a multi-outdoor-unit system has been connected in a multi-outdoor-unit system. • DIP switch setting of BS unit is incorrect. • Combination with T type (BSQ-TVJ, BS-Q54TVJ) and P type(BSVQ-PVJU, BSV-Q36PVJU) cause error. 	<ul style="list-style-type: none"> • Change to individual piping, and disconnect the wiring from the multi-outdoor-unit terminals (Q1, Q2). • Set up a DIP switch referring to service precaution of BS unit. • Configure the system with only T type, or only P type.
UF	There is conflict on the connection of transmission wiring in the system.	Check if the refrigerant piping line and the transmission wiring are consistent with each other.

E3 F6 UF	Refrigerant overcharge.	Recalculate the additional amount refrigerant from the piping length and correct the refrigerant charge level by recovering any excessive refrigerant with a refrigerant recovery machine.
E4 F3	Insufficient refrigerant.	<ul style="list-style-type: none"> • Check if the additional refrigerant charge has been finished correctly. • Recalculate the additional amount refrigerant from the piping length and add the adequate amount.
U7, U4 UF, UH	Field wiring is connected to "TO MULTI UNIT (Q1,Q2)" terminal on the outdoor unit PC-board (A1P) when the system is one outdoor system.	Remove the line from the "TO MULTI UNIT (Q1, Q2)" terminal.

NOTE

If any malfunction codes other than the above are displayed, check the service manual for how to respond.

12. ONSITE SETTINGS

Use the push button switches (BS1 through BS5) on the outdoor unit PC-board (A1P) to make the necessary onsite settings. See the "Service Precautions" label (upper) on the electrical components box lid for details on the positions and operating method of the push button switches and on the onsite setting. Make sure to record the setting on the accessory "REQUEST FOR THE INDICATION" label.

12-1 Energy saving and optimum operation

This VRV pump system is equipped with advanced energy saving functionality. Depending on the priority, emphasizes can be put on energy saving or comfort level. Several parameters can be selected, resulting in the optimal balance between energy consumption and comfort for the particular application.

[2-8]= Te target temperature during cooling operation

Default value=0

Te setting (cooling operation)										
○	●	○	○	○	○	○	○	○	○	Auto (default) ○ ● ● ● ● ● ● ● *
										37°F (3°C) ○ ● ● ● ● ● ● ● ○
										43°F (6°C) ○ ● ● ● ● ● ● ○ ●
										45°F (7°C) ○ ● ● ● ● ● ○ ○
										46°F (8°C) ○ ● ● ● ● ○ ● ●
										48°F (9°C) ○ ● ● ● ● ○ ● ○
										50°F (10°C) ○ ● ● ● ● ○ ● ●
										52°F (11°C) ○ ● ● ● ● ○ ○ ○

Change [2-8]=0, 2-7 in function of required operation method during cooling.

[2-9]= Tc target temperature during heating operation

Default value=0

Tc setting (heating operation)										
○	●	○	○	○	○	○	○	○	○	Auto (default) ○ ● ● ● ● ● ● ● *
										106°F (41°C) ○ ● ● ● ● ● ● ○
										108°F (42°C) ○ ● ● ● ● ● ○ ○
										109°F (43°C) ○ ● ● ● ● ● ○ ○
										111°F (44°C) ○ ● ● ● ● ○ ● ●
										113°F (45°C) ○ ● ● ● ● ○ ● ○
										115°F (46°C) ○ ● ● ● ● ○ ○ ●
										118°F (48°C) ○ ● ● ● ● ○ ○ ○

Change [2-9]=0, 1, 3 or 6 in function of required operation method during heating.

[2-49]= Te target temperature during simultaneous operation
Default value=0

Te setting (simultaneous operation)										
<input type="radio"/>	<input type="radio"/>	<input type="radio"/>	<input type="radio"/>	<input type="radio"/>	<input type="radio"/>	<input type="radio"/>	<input type="radio"/>	<input type="radio"/>	<input type="radio"/>	Auto (default) <input type="radio"/> ● ● ● ● ● ● ● ● *
										37°F (3°C) <input type="radio"/> ● ● ● ● ● ● ● ●
										43°F (6°C) <input type="radio"/> ● ● ● ● ● ● ● ●
										45°F (7°C) <input type="radio"/> ● ● ● ● ● ● ● ●
										46°F (8°C) <input type="radio"/> ● ● ● ● ● ● ● ●
										48°F (9°C) <input type="radio"/> ● ● ● ● ● ● ● ●
										50°F (10°C) <input type="radio"/> ● ● ● ● ● ● ● ●
										52°F (11°C) <input type="radio"/> ● ● ● ● ● ● ● ●

Change [2-49]=0, 2-7 in function of required operation method during simultaneous operation.

[2-33]= Cooling comfort setting
Default value=1

Cooling comfort setting										
<input type="radio"/>	<input type="radio"/>	<input type="radio"/>	<input type="radio"/>	<input type="radio"/>	<input type="radio"/>	<input type="radio"/>	<input type="radio"/>	<input type="radio"/>	<input type="radio"/>	Eco <input type="radio"/> ● ● ● ● ● ● ● ●
										Mild (default) <input type="radio"/> ● ● ● ● ● ● ● ● *
										Quick <input type="radio"/> ● ● ● ● ● ● ● ●
										Powerful <input type="radio"/> ● ● ● ● ● ● ● ●

Change [2-33]=0, 1, 2 or 3 in function of required limitation. This setting is used in conjunction with setting [2-8].

[2-34]= Heating comfort setting
Default value=1

Heating comfort setting										
<input type="radio"/>	<input type="radio"/>	<input type="radio"/>	<input type="radio"/>	<input type="radio"/>	<input type="radio"/>	<input type="radio"/>	<input type="radio"/>	<input type="radio"/>	<input type="radio"/>	Eco <input type="radio"/> ● ● ● ● ● ● ● ●
										Mild (default) <input type="radio"/> ● ● ● ● ● ● ● ● *
										Quick <input type="radio"/> ● ● ● ● ● ● ● ●
										Powerful <input type="radio"/> ● ● ● ● ● ● ● ●

Change [2-34]=0, 1, 2 or 3 in function of required limitation. This setting is used in conjunction with setting [2-9].

Several patterns are available and explained below. Modify the parameters to the needs of your building and to realize the best balance between energy consumption and comfort.

12-1-1 Three main operation methods are available:

- Basic**
The refrigerant temperature is fixed independent from the situation. It corresponds to the standard operation which is known and can be expected from/under previous VRV systems:
 - To activate this operation method under cooling operation, change field setting [2-8]=2.
 - To activate this operation method under heating operation, change field setting [2-9]=6.
- Automatic**
The refrigerant temperature is set depending on the outdoor ambient conditions. As such adjusting the refrigerant temperature to match the required load (which is also related to the outdoor ambient conditions).
E.g., when your system is operating in cooling, you do not need as much cooling under low outdoor ambient temperatures (e.g., 77°F (25°C)) as under high outdoor ambient temperatures (e.g., 95°F (35°C)).
Using this idea, the system automatically starts increasing its refrigerant temperature, automatically reducing the delivered capacity and increasing the system's efficiency.
 - To activate this operation method under cooling operation, change field setting [2-8]=0 (default).
 E.g., when your system is operating in heating, you do not need as much heating under high outdoor ambient temperatures (e.g., 59°F (15°C)) as under low outdoor ambient temperatures (e.g., 23°F (-5°C)).
Using this idea, the system automatically starts decreasing its refrigerant temperature, automatically reducing the delivered capacity and increasing the system's efficiency.
 - To activate this operation method under heating operation, change field setting [2-9]=0 (default).

- Hi-sensible/economic (cooling/heating)**
The refrigerant temperature is set higher/lower (cooling/heating) compared to basic operation. The focus under high sensible mode is comfort feeling for the customer.
The selection method of indoor units is important and has to be considered as the available capacity is not the same as under basic operation. For details concerning to Hi-sensible applications, please contact your dealer.
- To activate this setting under cooling operation, change field setting [2-8] to the appropriate value, matching the requirements of the pre-designed system containing a high sensible solution.

Value [2-8]	Te target
3	45°F (7°C)
4	46°F (8°C)
5	48°F (9°C)
6	50°F (10°C)
7	52°F (11°C)

- To activate this setting under heating operation, change field setting [2-9] to the appropriate value, matching the requirements of the pre-designed system containing a high sensible solution.

Value [2-9]	Tc target
1	106°F (41°C)
3	109°F (43°C)

12-1-2 Several comfort settings are available

For each of above modes a comfort level can be selected. The comfort level is related to the timing and the effort (energy consumption) which is put in achieving a certain room temperature by temporarily changing the refrigerant temperature to different values in order to achieve requested conditions more quickly.

- Powerful**
Overshoot (during heating operation) or undershoot (during cooling operation) is allowed compared to the requested refrigerant temperature, in order to achieve the required room temperature very fast. The overshoot is allowed from the start up moment.
In case of cooling operation the evaporating temperature is allowed to go down to 37°F (3°C) on temporary base depending on the situation.
In case of heating operation the condense temperature is allowed to go up to 120°F (49°C) on temporary base depending on the situation.
When the request from the indoor units becomes more moderate, the system will eventually go to the steady state condition which is defined by the operation method above.
 - To activate the powerful comfort setting under cooling operation, change field setting [2-33]=3.
 This setting is used in conjunction with setting [2-8].
 - To activate the powerful comfort setting under heating operation, change field setting [2-34]=3.
 This setting is used in conjunction with setting [2-9].
- Quick**
Overshoot (during heating operation) or undershoot (during cooling operation) is allowed compared to the requested refrigerant temperature, in order to achieve the required room temperature very fast. The overshoot is allowed from the start up moment.
In case of cooling operation the evaporating temperature is allowed to go down to 43°F (6°C) on temporary base depending on the situation.
In case of heating operation the condense temperature is allowed to go up to 115°F (46°C) on temporary base depending on the situation.
When the request from the indoor units becomes more moderate, the system will eventually go to the steady state condition which is defined by the operation method above.
 - To activate the quick comfort setting under cooling operation, change field setting [2-33]=2.
 This setting is used in conjunction with setting [2-8].
 - To activate the quick comfort setting under heating operation, change field setting [2-34]=2.
 This setting is used in conjunction with setting [2-9].

Mild

Overshoot (during heating operation) or undershoot (during cooling operation) is allowed compared to the requested refrigerant temperature, in order to achieve the required room temperature very fast. The overshoot is not allowed from the start up moment. The start up occurs under the condition which is defined by the operation mode above.

In case of cooling operation the evaporating temperature is allowed to go down to 43°F (6°C) on temporary base depending on the situation.

In case of heating operation the condense temperature is allowed to go up to 115°F (46°C) on temporary base depending on the situation.

When the request from the indoor units becomes more moderate, the system will eventually go to the steady state condition which is defined by the operation method above.

The start up condition is different from the powerful and quick comfort setting.

- To activate the mild comfort setting under cooling operation, change field setting [2-33]=1.

This setting is used in conjunction with setting [2-8].

- To activate the mild comfort setting under heating operation, change field setting [2-34]=1.

This setting is used in conjunction with setting [2-9].

Eco

The original refrigerant temperature target, which is defined by the operation method (see above) is kept without any correction, unless for protection control.

- To activate the mild comfort setting under cooling operation, change field setting [2-33]=0.

This setting is used in conjunction with setting [2-8].

- To activate the mild comfort setting under heating operation, change field setting [2-34]=0.

This setting is used in conjunction with setting [2-9].

Example: Automatic mode during cooling

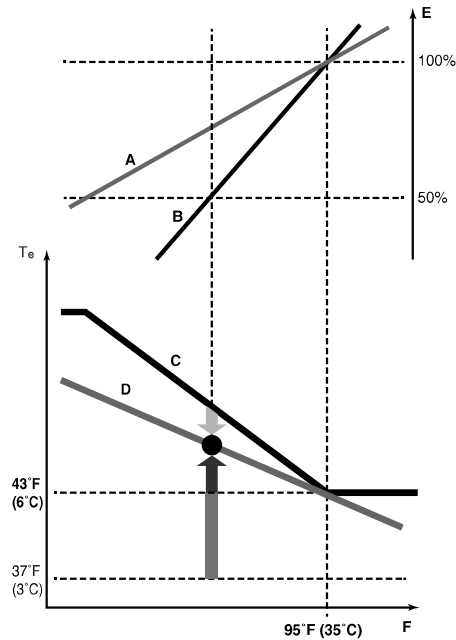

- A Actual load curve
- B Virtual load curve (initial capacity automatic mode)
- C Virtual target value (initial evaporation temperature value automatic mode)
- D Required evaporation temperature value
- E Load factor
- F Outside air temperature
- Te Evaporating temperature
- Quick
- Powerful
- Mild

Room temperature evolution:

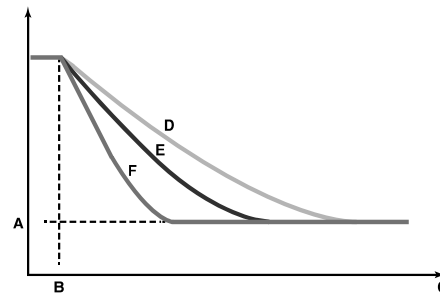

- A Indoor unit set temperature
- B Operation start
- C Operating time
- D Mild
- E Quick
- F Powerful

Example: Automatic mode during cooling

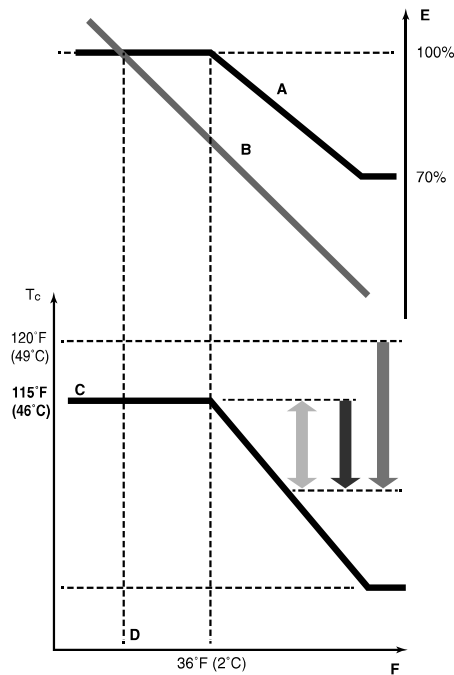

- A Virtual load curve (default automatic mode peak capacity)
- B Load curve
- C Virtual target value (initial condensation temperature value automatic mode)
- D Design temperature
- E Load factor
- F Outside air temperature
- T_c Condensing temperature
- Quick
- Powerful
- Mild

Room temperature evolution:

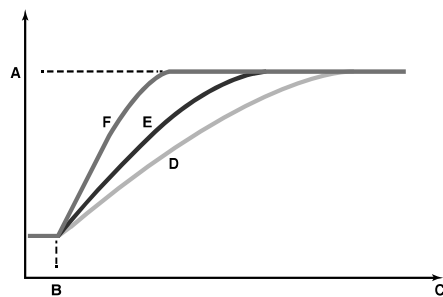

- A Indoor unit set temperature
- B Operation start
- C Operating time
- D Mild
- E Quick
- F Powerful

No matter which control is selected, variations on the behavior of the system are still possible due to protection controls to keep the unit operating under reliable conditions. The intentional target, however, is fixed and will be used to obtain the best balance between energy consumption and comfort, depending on the application type.

⚠ WARNING ⚡ Electric Shock Warning

Use an insulated rod to operate the push buttons via the inspection door of electrical components box lid. There is a risk of electric shock if you touch any live parts, since this operation must be performed with the power on.

13. TEST RUN

13-1 Before test run

- Make sure the following works are completed in accordance with the installation manual.
 - Piping work
 - Wiring work
 - Air tight test
 - Vacuum drying
 - Additional refrigerant charge
 - Check operation
- Check that all work for the BS, indoor unit are finished and there are no danger to operate.

13-2 Test Run

After all works are completed, operate the unit normally and check the following.

- (1) Make sure the indoor and outdoor units are operating normally.
- (2) Operate each indoor unit one by one and make sure the corresponding outdoor unit is also operating.
- (3) Check to see if cold (or hot) air is coming out from the indoor unit.
- (4) Push the fan direction and strength buttons on the remote controller to see if they operate properly.

⚠ NOTE

- Heating is not possible if the outdoor temperature is 75°F or higher. Refer to the Operation manual.
- If a knocking sound can be heard in the liquid compression of the compressor, stop the unit immediately and then energize the crank case heater for a sufficient length of time before restarting the operation.
- Once stopping, the compressor will not restart in about 5 minutes even if the On/Off button of the remote controller is pushed.
- When the system operation is stopped by the remote controller, the outdoor units may continue operating for further 5 minutes at maximum.
- The outdoor unit fan may rotate at low speeds if the Night-time low noise setting or the External low noise level setting is made, but this is not a malfunction.
- If the check operation was not performed at first installation, the malfunction code "U3" will be displayed in the remote controller. Perform the check operation following "11-2-2 Procedure of Check Operation".

13-3 Checks After Test Run

Perform the following checks after the test run is complete.

- Record the contents of field setting.
 - Record them on the accessory "REQUEST FOR THE INDICATION" label. And attach the label on the back side of the front panel.
- Record the installation date.
 - Record the installation date on the accessory "REQUEST FOR THE INDICATION" label in accordance with the IEC60335-2-40. And attach the label on the back side of the front panel.

⚠ NOTE

After the test run, when handing the unit over to the customer, make sure the electrical components box lid, the inspection door, and the unit casing are all attached.

14. CAUTION FOR REFRIGERANT LEAKS

(Points to note in connection with refrigerant leaks)

Introduction

The installer and system specialist shall secure safety against leakage according to local regulations or standards. The following standards may be applicable if local regulations are not available. The VRV System, like other air conditioning systems, uses R410A as refrigerant. R410A itself is an entirely safe non-toxic, non-combustible refrigerant. Nevertheless care must be taken to ensure that air conditioning facilities are installed in a room which is sufficiently large. This assures that the maximum concentration level of refrigerant gas is not exceeded, in the unlikely event of major leak in the system and this in accordance to the local applicable regulations and standards.

Maximum concentration level

The maximum charge of refrigerant and the calculation of the maximum concentration of refrigerant is directly related to the humanly occupied space in to which it could leak.

The unit of measurement of the concentration is lb/ft³ (the weight in lb of the refrigerant gas in 1 ft³ volume of the occupied space).

Compliance to the local applicable regulations and standards for the maximum allowable concentration level is required.

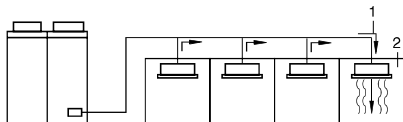

1. direction of the refrigerant flow
2. room where refrigerant leak has occurred (outflow of all the refrigerant from the system)

Pay a special attention to the place, such as a basement, etc. where refrigerant can stay, since refrigerant is heavier than air.

Procedure for checking maximum concentration

Check the maximum concentration level in accordance with steps 1 to 4 below and take whatever action is necessary to comply.

1. Calculate the amount of refrigerant (lb) charged to each system separately.

amount of refrigerant in a single unit system (amount of refrigerant with which the system is charged before leaving the factory)	+	additional charging amount (amount of refrigerant added locally in accordance with the length or diameter of the refrigerant piping)	=	total amount of refrigerant (lb) in the system
---	---	--	---	--

NOTE

- Where a single refrigerant facility is divided into 2 entirely independent refrigerant systems then use the amount of refrigerant with which each separate system is charged.

2. Calculate the smallest room volume (ft³)

In case like the following, calculate the volume of (A), (B) as a single room or as the smallest room.

- A.** Where there are no smaller room divisions

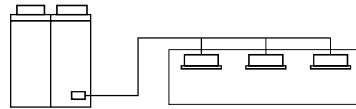

- B.** Where there is a room division but there is an opening between the rooms sufficiently large to permit a free flow of air back and forth.

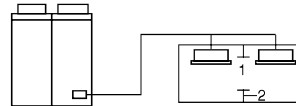

1. opening between rooms
2. partition

(Where there is an opening without a door or where there are openings above and below the door which are each equivalent in size to 0.15% or more of the floor area.)

3. Calculating the refrigerant density using the results of the calculations in steps 1 and 2 above.

$$\frac{\text{total volume of refrigerant in the refrigerant system}}{\text{size (ft}^3\text{) of smallest room in which there is an indoor unit installed}} \leq \text{maximum concentration level (lb/ft}^3\text{)}$$

If the result of the above calculation exceeds the maximum concentration level then make similar calculations for the second then third smallest room and so until the result falls short of the maximum concentration.

4. Dealing with the situations where the result exceeds the maximum concentration level.

Where the installation of a facility results in a concentration in excess of the maximum concentration level then it will be necessary to revise the system. Please consult your Daikin supplier.