



Shaping air to your needs



- Daikin products are manufactured for export to numerous countries throughout the world. Prior to purchase, please confirm with your local authorised importer, distributor and/or retailer whether this product conforms to the applicable standards, and is suitable for use, in the region where the product will be used. This statement does not purport to exclude, restrict or modify the application of any local legislation.
 - Ask a qualified installer or contractor to install this product. Do not try to install the product yourself. Improper installation can result in water or refrigerant leakage, electrical shock, fire or explosion.
 - Use only those parts and accessories supplied or specified by Daikin. Ask a qualified installer or contractor to install those parts and accessories. Use of unauthorised parts and accessories or improper installation of parts and accessories can result in water or refrigerant leakage, electrical shock, fire or explosion.
 - Read the User's Manual carefully before using this product. The User's Manual provides important safety instructions and warnings. Be sure to follow these instructions and warnings.
- If you have any enquiries, please contact your local importer, distributor and/or retailer.

VRF-WIII

THE INTELLIGENT AIR CONDITIONING SYSTEM



Cautions on product corrosion

1. Air conditioners should not be installed in areas where corrosive gases, such as acid gas or alkaline gas, are produced.
2. If the outdoor unit is to be installed close to the sea shore, direct exposure to the sea breeze should be avoided. If you need to install the outdoor unit close to the sea shore, contact your local distributor.



Organization:
DAIKIN INDUSTRIES, LTD.
AIR CONDITIONING MANUFACTURING DIVISION

Scope of Registration:
THE DESIGN/DEVELOPMENT AND MANUFACTURE OF COMMERCIAL AIR CONDITIONING, HEATING, COOLING, REFRIGERATING EQUIPMENT, HEATING EQUIPMENT, RESIDENTIAL AIR CONDITIONING EQUIPMENT, HEAT RECLAIM VENTILATION, AIR CLEANING EQUIPMENT, COMPRESSORS AND VALVES.

JMI-0107



Organization:
DAIKIN INDUSTRIES (THAILAND) LTD.

Scope of Registration:
THE DESIGN/DEVELOPMENT AND MANUFACTURE OF AIR CONDITIONERS AND THE COMPONENTS INCLUDING COMPRESSORS USED FOR THEM

JQA-1452



Organization:
All of the Daikin Group's business facilities and subsidiaries in Japan are certified under the ISO 14001 international standard for environment management.

EC99J2044

Dealer

DAIKIN INDUSTRIES, LTD.
Head Office:
Umeda Center Bldg., 2-4-12, Nakazaki-Nishi, Kita-ku, Osaka, 530-8323 Japan
Tokyo Office:
JR Shinagawa East Bldg., 2-18-1, Konan, Minato-ku, Tokyo, 108-0075 Japan
http://www.daikin.com/global_ac/

©All rights reserved 08/12 Y.K.

● Specifications, designs and other content appearing in this brochure are current as of August 2012 but subject to change without notice.

WATER COOLED INVERTER SERIES

HEAT PUMP 50 Hz/60 Hz
HEAT RECOVERY 50 Hz/60 Hz

R-410A

A water cooled intelligent individual air conditioning system suitable for tall multi-storeyed buildings.

This unique system can perform as heat pump or heat recovery to any suitable application.



What is water cooled VRVIII?

Water cooled VRVIII is an individual air conditioning system that utilises water as a heat source. In this unique system, water is piped from a cooling tower or boiler to the VRV-WIII (which is the equivalent of the outdoor unit of an air cooled conditioning system) and after heat exchange, refrigerant is piped from the VRV-WIII to each indoor unit.

What are its advantages?

Design flexibility	page 3
Easy installation	page 5
Energy saving	page 6
Enhanced usability	page 7

VRV-WIII

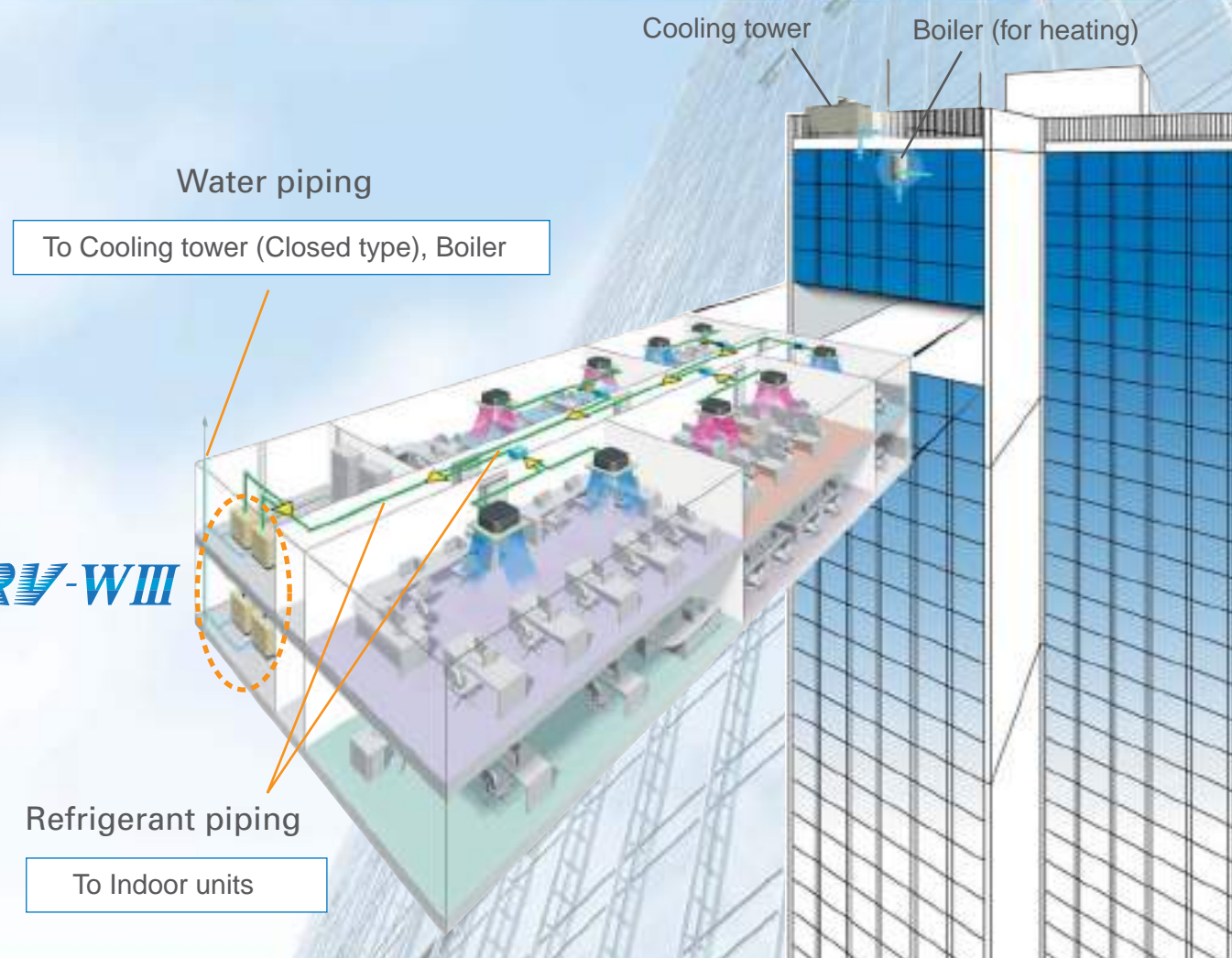

Cutting-edge technologies

The compact unit is packed with the latest technologies.

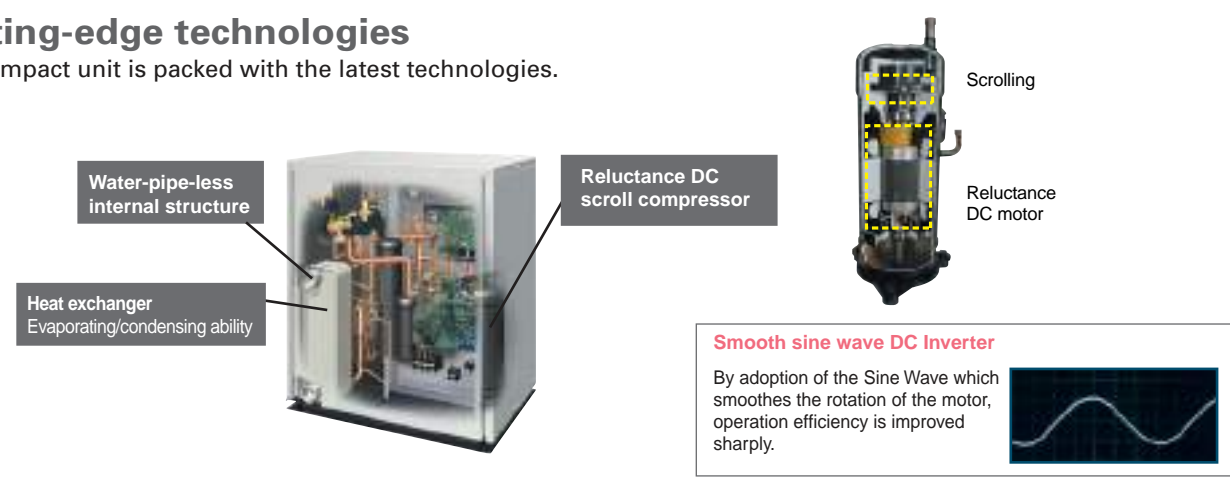

features

Design flexibility

Enhanced design flexibility

Water cooled VRV8 uses water as its heat source, so it is optimal for large buildings, including tall, multi-storey buildings, because the system can tolerate water pressure of up to 1.96 MPa. Furthermore, if the currently installed heat source's water temperature is between 10°C and 45°C, it may be possible to use the existing water pipe work and heat source. This alone makes it an ideal system solution for building refurbishment projects. Because the system is water cooled, outdoor air temperature does not affect its heating capacity. In addition, water cooling means no defrost operation is required, and the resultant rapid start-up time assures quick and comfortable heating, even in cold environments.

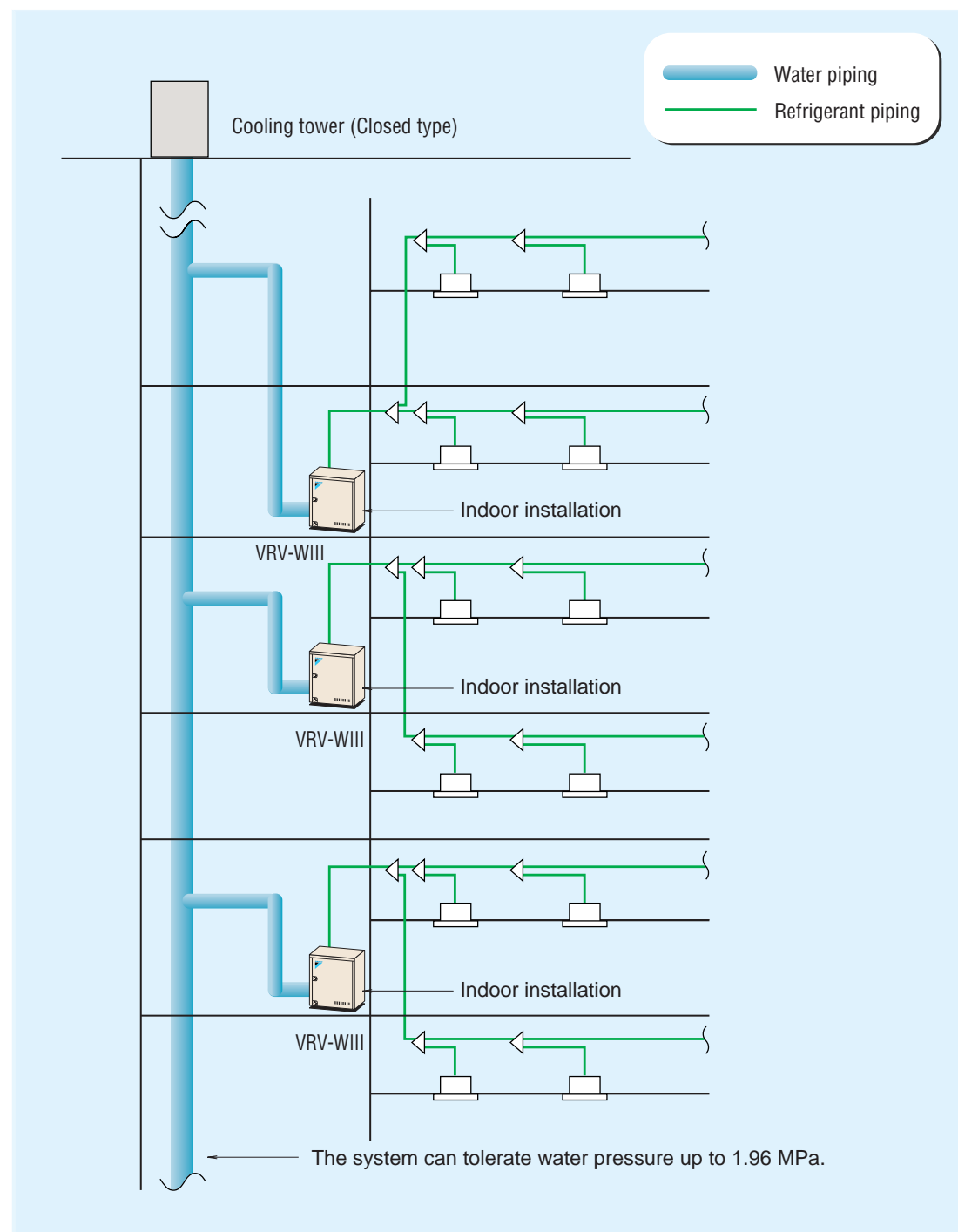

Long refrigerant piping length

Within the refrigerant piping system, a maximum of 120 m of actual piping length and 50 m of level difference between the VRV-WIII and indoor units are possible. Water piping does not enter occupied spaces, so there is little chance of water leaking.

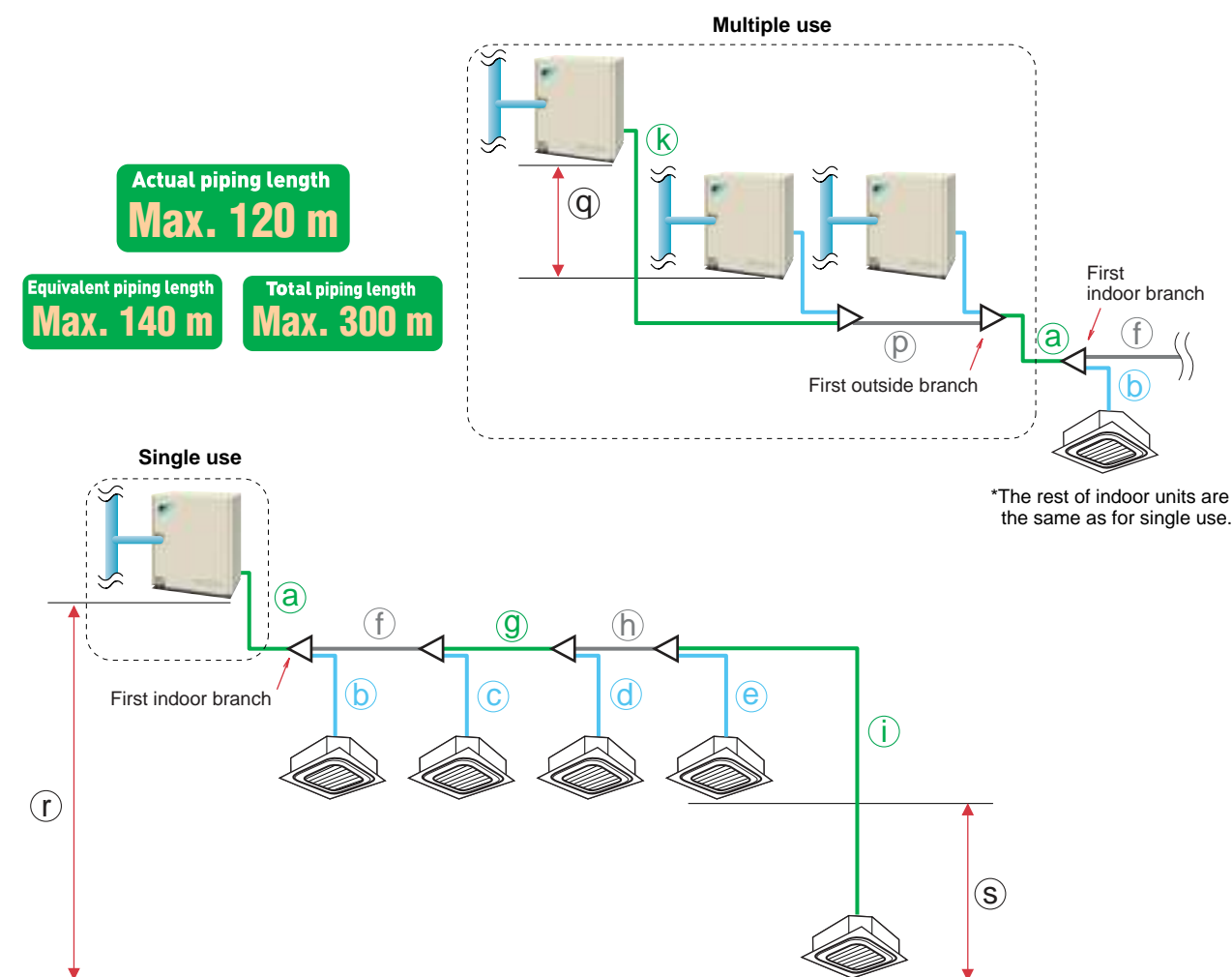

*The rest of indoor units are the same as for single use.

* Colours in the diagram above are merely for identifying pipes referenced with symbols such as @.

		Actual piping length	Example	Equivalent piping length
Maximum allowable piping length	Refrigerant piping length	120 m	a+f+g+h+i	140 m
	Total piping length	300 m	a+b+c+d+e+f+g+h+i	—
	Between the first indoor branch and the farthest indoor unit	90 m ^{*1}	f+g+h+i	—
	Between the first outside branch and the last outside unit	10 m	k+p	13 m
Maximum allowable level difference	Between the outside units (multiple use)	2 m	q	—
	Between the indoor units	15 m	s	—
	Between the outside units and the indoor units	If the outside unit is above. 50 m If the outside unit is below. 40 m	r	—

*1 No special requirements up to 40 m. The maximum actual piping length can be 90 m, depending on conditions. Various conditions and requirements have to be met to allow utilisation of 90 m piping length. Be sure to refer to the Engineering Data Book for details of these conditions and requirements.

features

Easy installation

Compact and lightweight

Adoption of a water heat exchanger and optimisation of the refrigerant control circuit has resulted compact and lightweight equipment. A weight of 149 kg and height of 1,000 mm make installation possible in buildings with limited space, or where no space is available for outdoor units. This makes the system ideal for places that have no area outside—such as underground malls. Stacked configuration is also possible, further contributing to space savings.

* The unit is designed for indoor installation only.

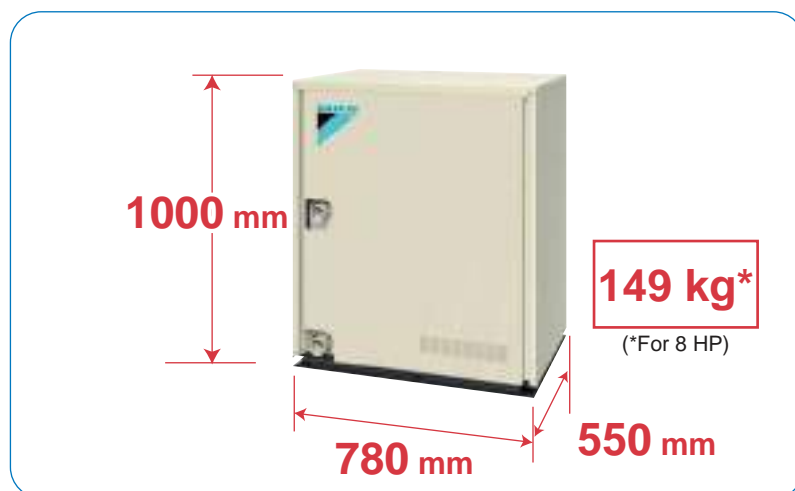

Stacked-configuration in indoor installation is possible.

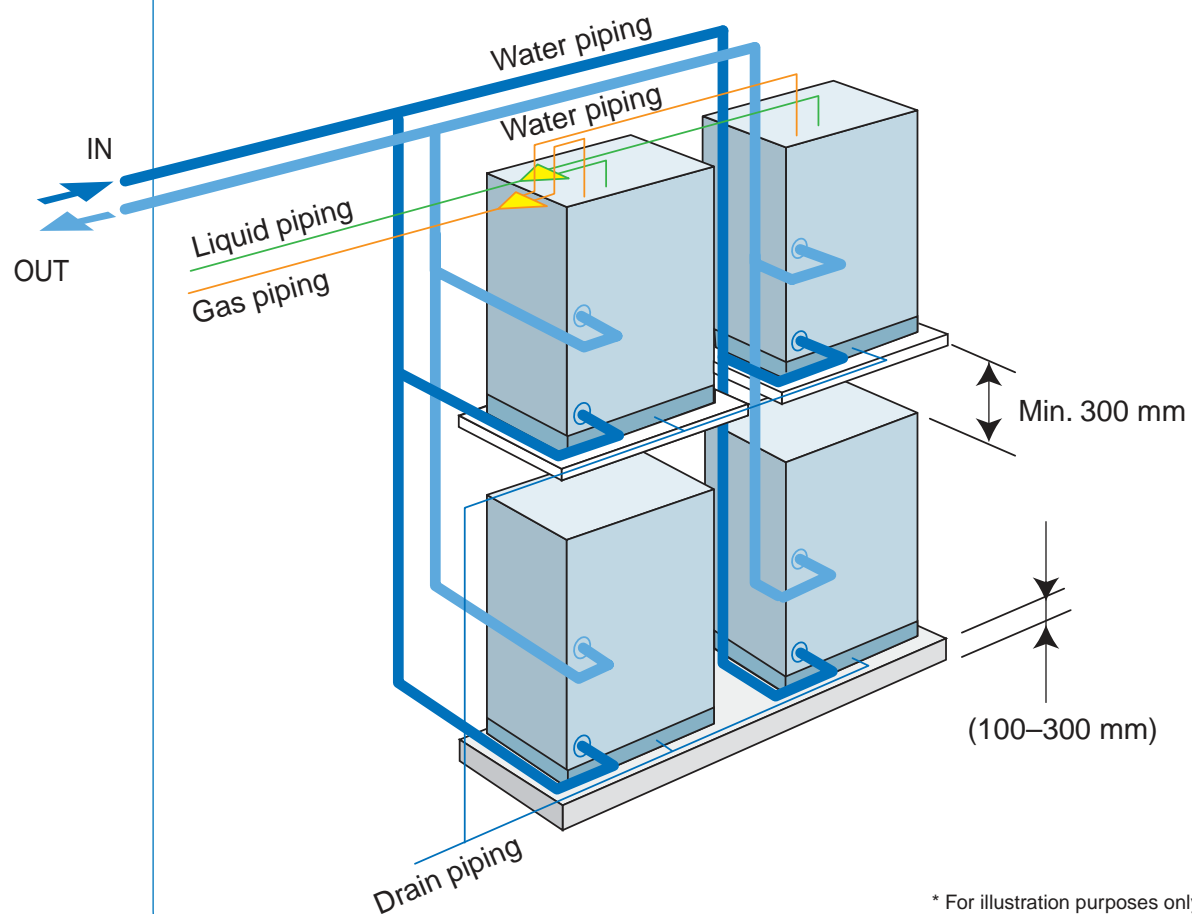

* For illustration purposes only.

features

Energy saving

Heat recovery

Daikin offers 2-stage heat recovery operation. The first stage of heat recovery operation is within the refrigerant system. By controlling the BS unit that switches cooling and heating, simultaneous cooling and heating operation is made possible, with heat recovery performed between indoor units. The second stage of heat recovery operation is within the water loop, where heat recovery is performed between the VRV-WIII systems. This 2-stage heat recovery operation substantially improves energy efficiency and makes the system the ideal solution to the requirements of modern office buildings, where some areas may require cooling even in winter, depending on the amount of sunshine received and the number of people in the room.

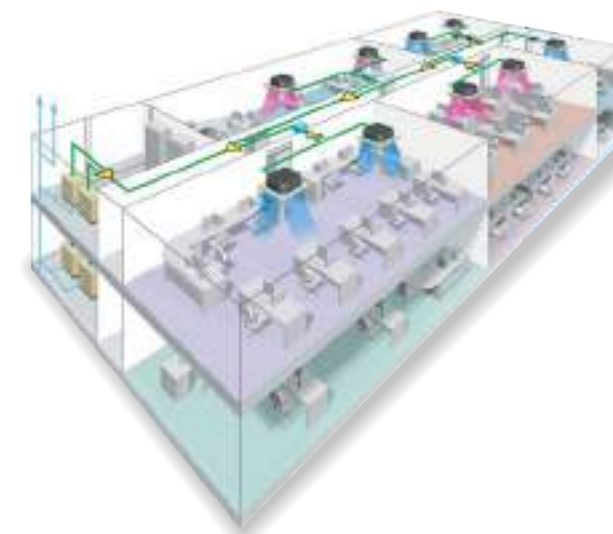

Stage 1

Simultaneous heating and cooling operation within the refrigerant system.

In mainly cooling, partly heating mode, the system recycles heat exhausted from the cooling operation to use for heating. In mainly heating, partly cooling mode, the system uses cooled post-heating operation refrigerant for cooling. Efficiency improves the more simultaneous operation is performed.

The first stage: Between indoor units

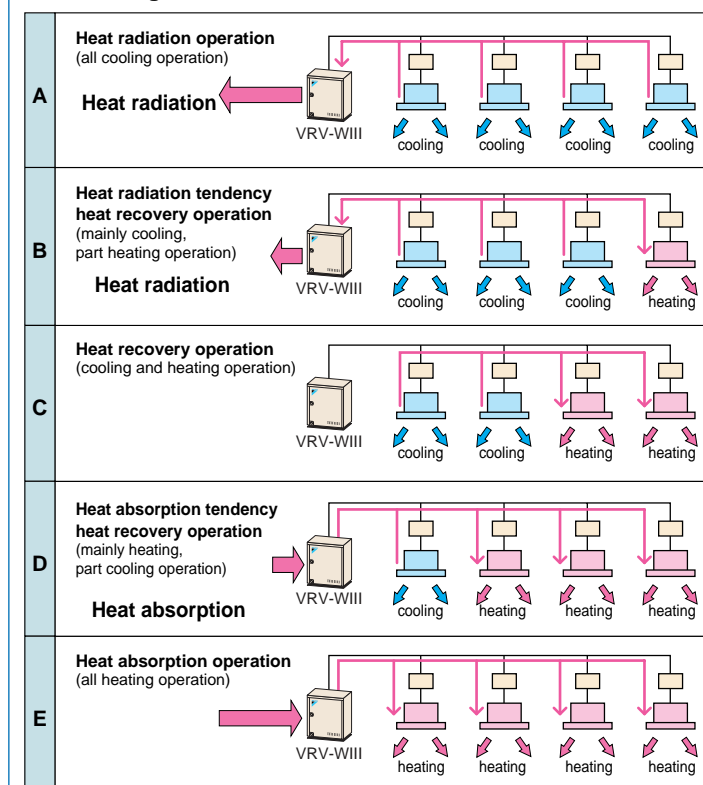

Note: * Above system configurations are for illustration purposes only.

Stage 2

Heat recovery operation between the VRV-WIII systems.

Heat recovery operation is also available between systems connected to the same water loop, with systems exchanging heat via water. This increases energy efficiency.

The second stage: Between VRV-WIII systems

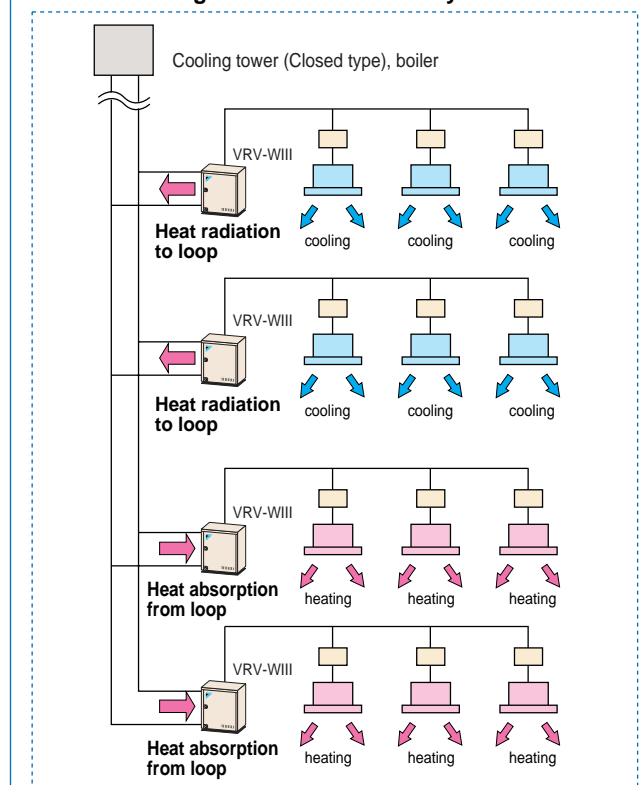

Enhanced usability

A variety of functions that realise easy installation and improve reliability

- Features a pump interlock function that controls the pump of the heat source simultaneously with the starting of the VRV-WIII unit. This significantly simplifies operation and management.
- Employs DIII-NET to enable the shared use of the wiring between the indoor units, the VRV-WIII unit and the central control wiring.
- Provides an auto address setting function and check function that detects connection errors in wiring and piping for easier installation.
- Water piping goes only to the VRV-WIII unit, with refrigerant piping run in occupied spaces, so there is little chance of water leakage or corrosion.

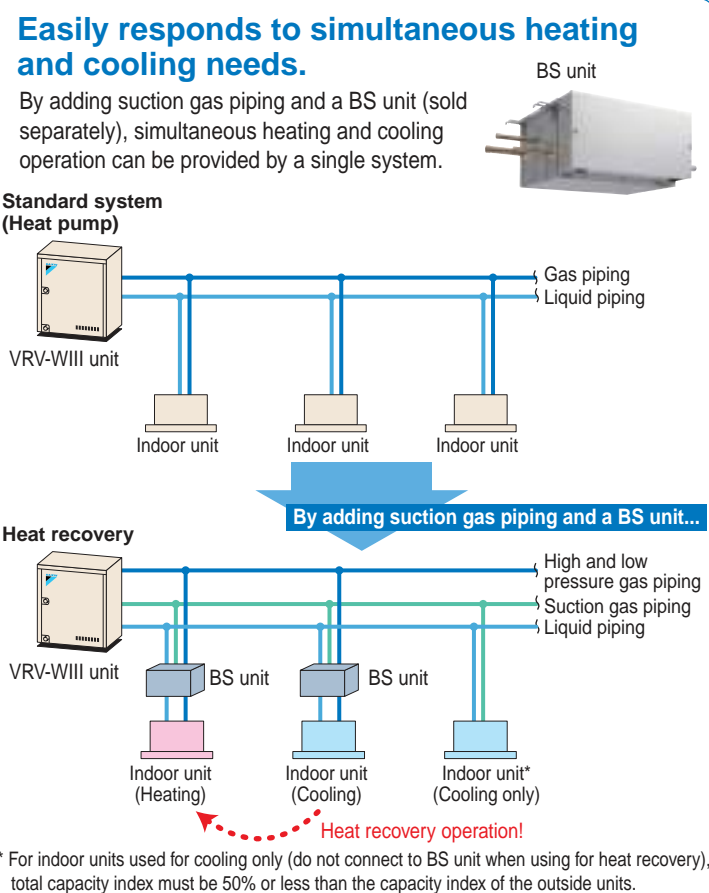

Centralised interlocking function

Centralised interlocking input is possible using an external control adaptor (DTA104A62).

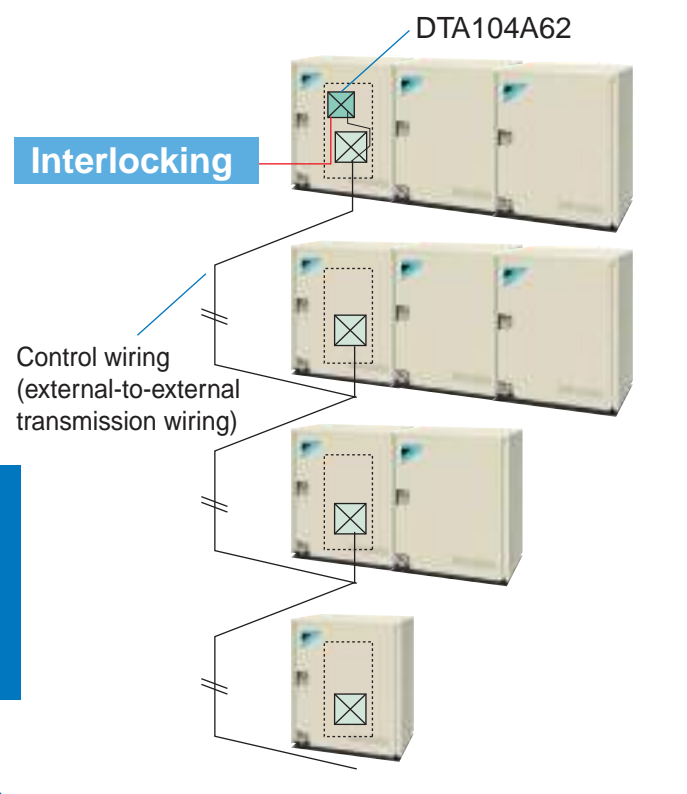

2 types of BS units for heat recovery can improve design flexibility.

A BS unit can switch between cooling and heating operations itself, successfully reducing the effect on other indoor units (compared to the VRV-WII system).

BS unit



Centralised BS unit (50 Hz only)



- BS unit for heat recovery can improve comfortability by switching between cooling and heating operations independently.

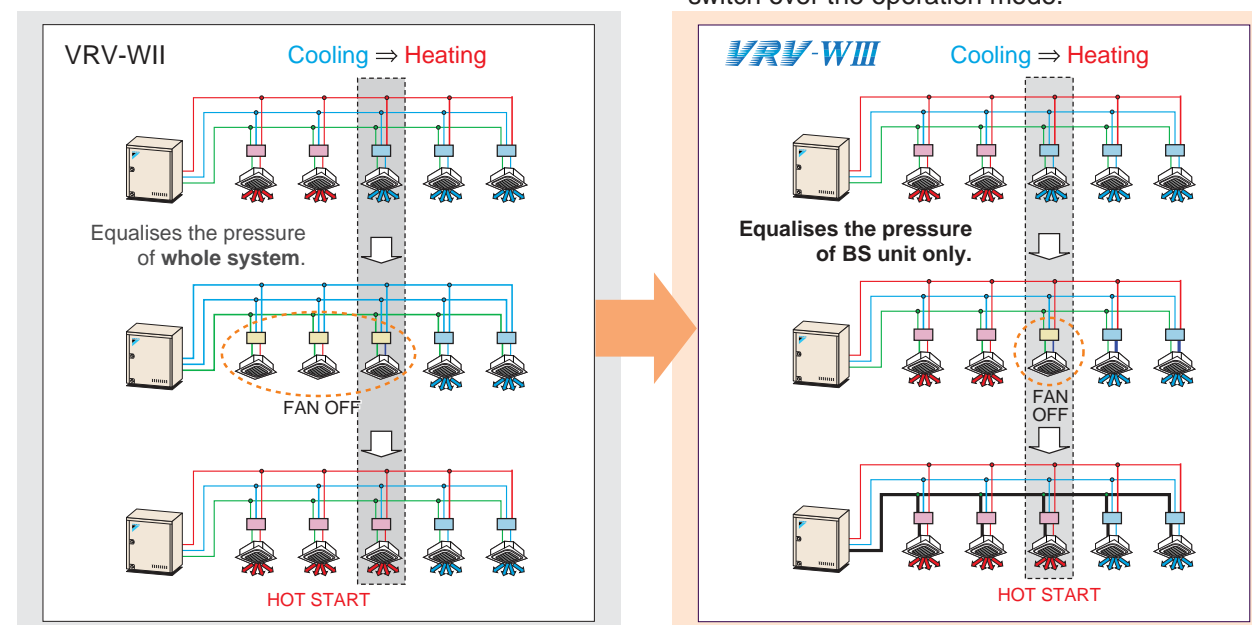

- Installation and maintenance work have been made easier through the integration of multiple BS units.

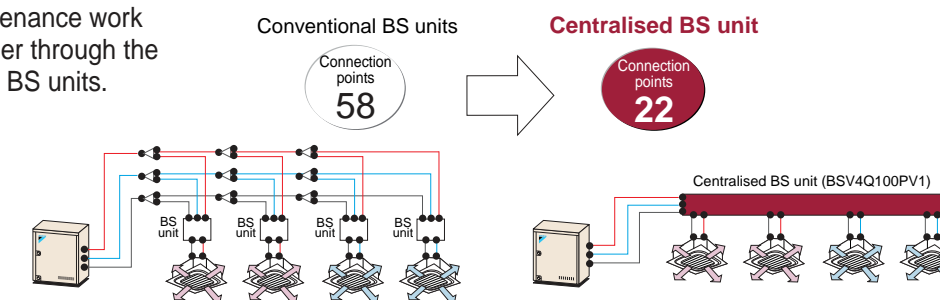

- Combined use of a new centralised BS unit and conventional BS units meets the needs of many design plans.

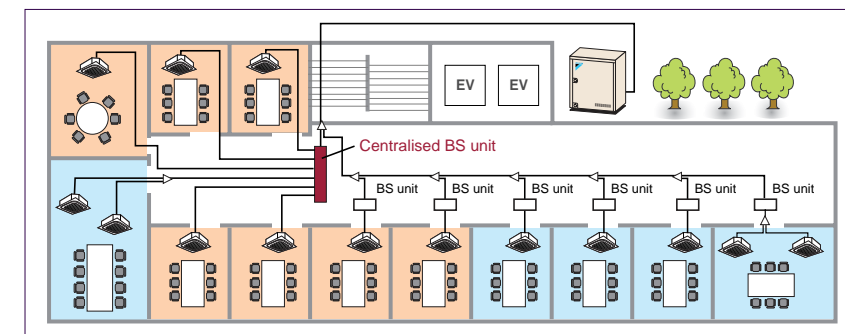

Outside unit lineup

A lineup of 8 to 30 HP models meets wide-ranging office space requirements. The modular design imparts a simple and smart appearance and makes units easy to install.

Series Lineup

Series	Capacity range										
	8 HP	10 HP	16 HP	18 HP	20 HP	24 HP	26 HP	28 HP	30 HP		
Heat pump	50 Hz	●	●	●	●	●	●	●	●	●	
	60 Hz	—	●	—	—	●	—	—	—	●	
Heat recovery	50 Hz	●	●	●	●	●	●	●	●	●	
	60 Hz	—	●	—	—	●	—	—	—	●	

HP	Capacity index	Model	Combination	Total capacity index of connectable indoor units*2	Maximum number of connectable indoor units
8	200	RWEYQ8P	RWEYQ8P × 1	100 to 260	13
10	250	RWEYQ10P	RWEYQ10P × 1	125 to 325	16
16	400	RWEYQ16P*1	RWEYQ8P × 2	200 to 520	26
18	450	RWEYQ18P*1	RWEYQ8P + RWEYQ10P	225 to 585	29
20	500	RWEYQ20P*1	RWEYQ10P × 2	250 to 650	32
24	600	RWEYQ24P*1	RWEYQ8P × 3	300 to 780	36
26	650	RWEYQ26P*1	RWEYQ8P × 2 + RWEYQ10P	325 to 845	
28	700	RWEYQ28P*1	RWEYQ8P + RWEYQ10P × 2	350 to 910	
30	750	RWEYQ30P*1	RWEYQ10P × 3	375 to 975	

Outside unit combinations

*1 An outside unit multi connection piping kit (option) is necessary for multiple connections of 16 HP systems and above.
 *2 Total capacity index of connectable indoor units must be 50%–130% of the capacity index of the outside units. For indoor units used for cooling only (do not connect to BS unit when using for heat recovery), total capacity index must be 50% or less than the capacity index of the outside units.

Example piping layout (Heat pump system)

24–30 HP

* For illustration purposes only.



* Strainer kit is equipped as a standard accessory with 60Hz models.

Indoor unit lineup

Type	Model Name	Capacity Range Capacity Index	20	25	32	40	50	63	80	100	125	140	200	250
			0.8 HP	1 HP	1.25 HP	1.6 HP	2 HP	2.5 HP	3.2 HP	4 HP	5 HP	6 HP	8 HP	10 HP
Ceiling Mounted Cassette (Round Flow)	FXFQ-PVE		●	●	●	●	●	●	●	●	●			
Ceiling Mounted Cassette (Compact Multi Flow)	FXZQ-MVE		●	●	●	●	●							
Ceiling Mounted Cassette (Double Flow)	FXCQ-MVE		●	●	●	●	●	●	●		●			
Ceiling Mounted Cassette Corner	FXKQ-MAVE			●	●	●		●						
Slim Ceiling Mounted Duct	FXDQ-PBVE (with drain pump)		●	●	●									
	FXDQ-PBVET (without drain pump) (700 mm width type)		●	●	●									
	FXDQ-NBVE (with drain pump)					●	●	●						
	FXDQ-NBVET (without drain pump) (900/1,100 mm width type)					●	●	●						
Ceiling Mounted Duct	FXMQ-PVE		●	●	●	●	●	●	●	●	●	●	●	
	FXMQ-MAVE												●	●
Ceiling Suspended	FXHQ-MAVE				●			●		●				
Wall Mounted	New FXAQ-PVE		New	New	New	New	New	New						
Floor Standing	FXLQ-MAVE		●	●	●	●	●	●						
Concealed Floor Standing	FXNQ-MAVE		●	●	●	●	●	●						

Note: R-410A VRV system indoor units are not compatible with the R-22 VRV system.

Connection unit series indoor units (50 Hz only)

Type	Model Name	Capacity Range Capacity Index	20	25	32	40	50	71	100	125	
			0.8 HP	1 HP	1.25 HP	1.6 HP	2 HP	3 HP	4 HP	5 HP	
Ceiling Suspended Cassette	FXUQ-MAV1								●	●	●

Note: BEV units are necessary for Connection unit series indoor units. Refer to the Engineering Data Book for details.

Indoor unit lineup

Ceiling Mounted Cassette (Round Flow) Type

FXFQ25P/FXFQ32P/FXFQ40P
FXFQ50P/FXFQ63P/FXFQ80P
FXFQ100P/FXFQ125P



360° airflow improves temperature distribution and offers a comfortable living environment.

- The industry's first* Round Flow Ceiling Mounted Cassette type offers 360° airflow with improved temperature distribution.

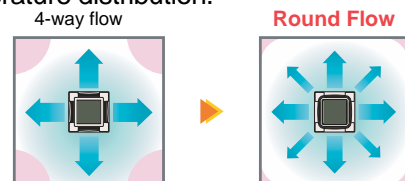

There are areas of uneven temperature.

There are much fewer areas of uneven temperature.

*As of April 2004, the release date for Japan.

- All models are lighter than the conventional ones. Ex: Models FXFQ25P-50P are 4.5 kg lighter (reduced from 24 kg to 19.5 kg).

- Drain pump is equipped as standard accessory, and the lift height has been improved from 750 mm to 850 mm.

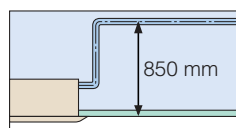

- A modern sophisticated decoration panel has been applied, with a panel surface that has been treated with a dirt-repellant coating.



- Control of the airflow rate has been improved from 2-step to 3-step control.

- Low operation sound level

FXFQ-P	25/32	40	50	63	80	100	125
Sound level (HH/H/L)	30/28.5/27	31/29/27	32/29.5/27	34/31/28	36/33.5/31	43/37.5/32	44/39/34

- Example of airflow patterns: 360° airflow is available, as well as 2- to 4-way flows, so you can choose the most suitable airflow pattern depending on location or room layout.

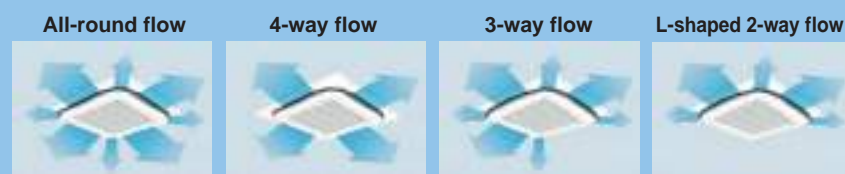

- An antibacterial treatment that uses silver ions has been applied to the drain pan, preventing the growth of slime, mould and bacteria that cause blockages and odours.

- The horizontal louvres prevent dew condensation. Their non-flocking surfaces, which repel dirt, are easy to clean.

- The air filter has an anti-mould and antibacterial treatment that prevents the growth of mould generated from dust or moisture that may adhere to the filter.

Note: Whatever the discharge direction, the same type of panel is used. If installing for other than all-round flow, an air discharge outlet sealing member (option) must be used to close each unused outlet.

Ceiling Mounted Cassette (Compact Multi Flow) Type

FXZQ20M/FXZQ25M
FXZQ32M/FXZQ40M
FXZQ50M



Quiet, compact, and designed for user comfort

- Dimensions correspond with 600 mm × 600 mm architectural module ceiling design specifications.

- Low operation sound level

FXZQ-M		20/25	32	40	50
Sound level (H/L)	230 V	30/25	32/26	36/28	41/33
	240 V	32/26	34/28	37/29	42/35

- Comfortable airflow

- Wide discharge angle: 0° to 60°

- Auto swing

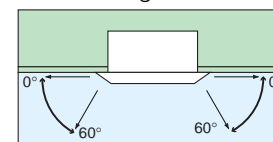

- Fixed angles: 5 levels

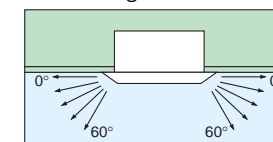

*Angles can be also set on site to prevent drafts (0°-35°) or soiling of the ceiling (25°-60°), other than standard setting (0°-60°).

- 2-, 3-, and 4-way airflow patterns are available, enabling installation in the corner of a room.

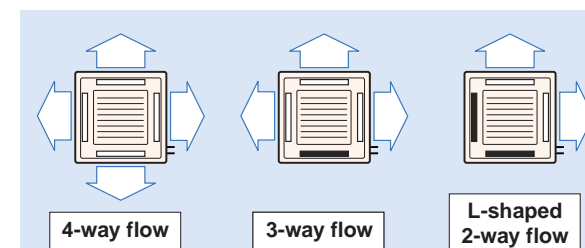

*For 3-way or 2-way flow installation, the sealing member for air discharge outlet (option) must be used to close each unused outlet.



- Drain pump is equipped as standard accessory with 750 mm lift.

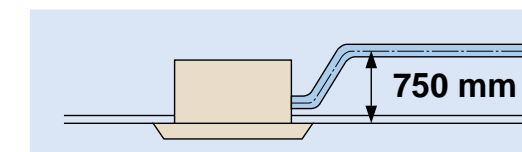

Indoor unit lineup

Ceiling Mounted Cassette (Double Flow) Type

FXCQ20M/FXCQ25M/FXCQ32M
FXCQ40M/FXCQ50M/FXCQ63M
FXCQ80M/FXCQ125M



Thin, lightweight, and easy to install in narrow ceiling spaces

- The low profile unit (only 305 mm high) can be installed in a ceiling space as shallow as 350 mm. All models feature a compact design with a depth of only 600 mm.

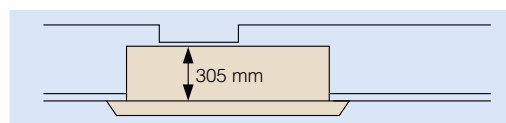

(When a high-efficiency filter is attached, the unit's height is 400 mm.)

- Low operation sound level (dB(A))

FXCQ-M	20	25/32	40/50	63	80	125
Sound level (H/L)	220 V 32/27	34/28	34/29	37/32	39/34	44/38
	240 V 34/29	36/30	37/32	39/34	41/36	46/40

- Designed with higher airflow suitable for high ceiling application up to 3 metres.

- Providing 2 different settings of standard and ceiling soiling prevention, the auto swing mechanism achieves even distribution of airflow and room temperature.

- Drain pump is equipped as standard accessory with 600 mm lift.

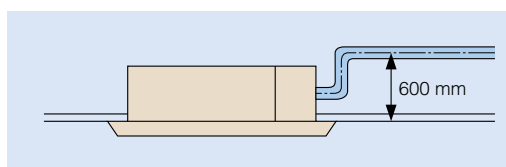

- Two types of optional high-efficiency filter are available (65% and 95%, colourimetric method).

- A long-life filter (maintenance free up to one year*) is equipped as standard accessory.

* 8 hr/day, 25 day/month. For dust concentration of 0.15 mg/m³

- Major maintenance work can be performed by removing the panel. A flat-type suction grille and a detachable blade make cleaning easy.

Ceiling Mounted Cassette Corner Type

FXKQ25MA/FXKQ32MA
FXKQ40MA/FXKQ63MA



Slim design for flexible installation

- Slim body needs only 220 mm space above the ceiling. If you use a panel spacer (option), the unit can be installed in the minimum space of 195 mm.

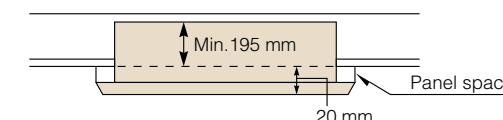

- Single-flow type allows effective air discharge from corner or from drop-ceiling.
- Drain pump is equipped as standard accessory with 500 mm lift.

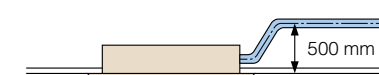

- Providing 3 different settings of standard, draft prevention and ceiling soiling prevention, the auto swing mechanism achieves even distribution of airflow and room temperature.

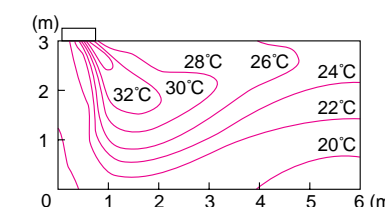

- Front discharge is possible with an air discharge unit (option), which allows the installation in the drop-ceiling or sagging wall.

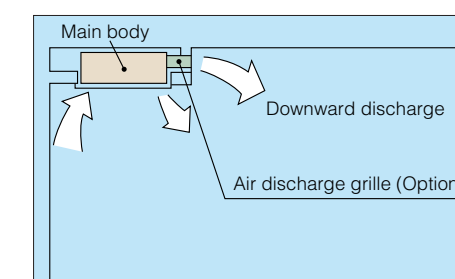

*Set for front discharge using a suspended ceiling.

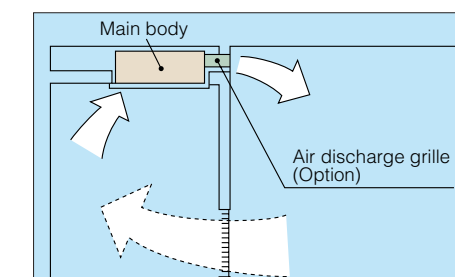

*Downward discharge is shut off and air is blown straight out (front discharge).



- A long-life filter (maintenance free up to one year*) is equipped as standard accessory.

* 8 hr/day, 25 day/month. For dust concentration of 0.15 mg/m³

Indoor unit lineup

Slim Ceiling Mounted Duct Type



Slim design, quietness and static pressure switching

Suited to use in drop-ceilings!

FXDQ20PB/FXDQ25PB/FXDQ32PB

- Only 700 mm in width and 23 kg in weight, this model is suitable to install in limited spaces like drop-ceilings in hotels.

Great for hotel use!

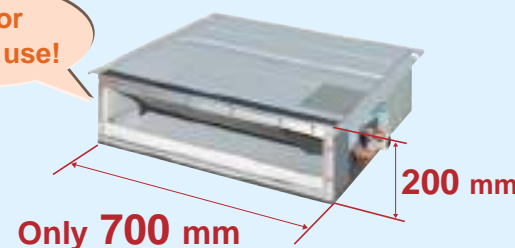

FXDQ40NB/FXDQ50NB/FXDQ63NB

- Only 200 mm in height, this model can be installed in rooms with as little as 240 mm depth between the drop-ceiling and ceiling slab.

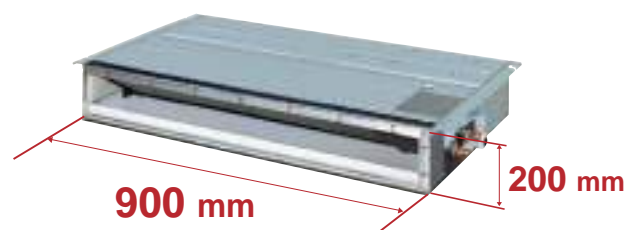

* 1,100 mm in width for the FXDQ63NB model.

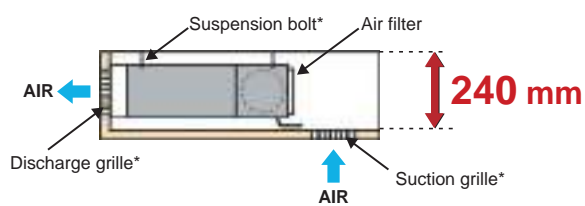

* To be obtained locally

- External static pressure selectable by remote controller switching make this indoor unit a very comfortable and flexible model.

10 Pa-30 Pa/factory set: 10 Pa for FXDQ-PB models.
15 Pa-44 Pa/factory set: 15 Pa for FXDQ-NB models.

- FXDQ-PB and FXDQ-NB models are available in two types to suit different installation conditions.

FXDQ-PB/NBVE: with a drain pump (750 mm lift) as a standard accessory

FXDQ-PB/NBVET: without a drain pump

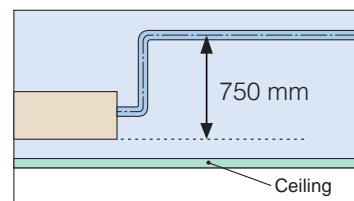

- Control of the airflow rate has been improved from 2-step to 3-step control.

- Low operation sound level

FXDQ-PB/NB	20/25/32	40	50	63
Sound level (HH/H/L)	33/31/29	34/32/30	35/33/31	36/34/32

*The values of operation sound level represent those for rear-suction operation. Sound level values for bottom-suction operation can be obtained by adding 5 dB(A).
*Values are based on the following conditions:
FXDQ-PB: external static pressure of 10 Pa; FXDQ-NB: external static pressure of 15 Pa.



Ceiling Mounted Duct Type

**FXMQ20P/FXMQ25P/FXMQ32P
FXMQ40P/FXMQ50P/FXMQ63P
FXMQ80P/FXMQ100P/FXMQ125P
FXMQ140P**



Middle and high static pressure allows for flexible duct design

- A DC fan motor increases the external static pressure capacity range to include middle to high static pressures, increasing design flexibility.

30 Pa-100 Pa for FXMQ20P-32P
30 Pa-160 Pa for FXMQ40P
50 Pa-200 Pa for FXMQ50P-125P
50 Pa-140 Pa for FXMQ140P

- All models are only 300 mm in height, an improvement over the 390 mm height of conventional models. The weight of the FXMQ40P has been reduced from 44 kg to 28 kg.

- Drain pump is equipped as standard accessory with 700 mm lift.

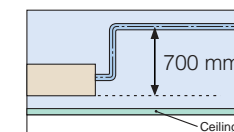

- Control of the airflow rate has been improved from 2-step to 3-step control.

Low operation sound level (dB(A))

FXMQ-P	20/25	32	40	50	63	80/100	125	140
Sound level (HH/H/L)	33/31/29	34/32/30	39/37/35	41/39/37	42/40/38	43/41/39	44/42/40	46/45/43

- Energy-efficient

- The adopted DC fan motor is much more efficient than the conventional AC motor, yielding an approximate 20% decrease in energy consumption (FXMQ125P).



- Improved ease of installation

- Airflow rate can be controlled using a remote controller during test operation. With the conventional model, the airflow rate was controlled from the PC board. It is automatically adjusted to the range between approximately ±10% of the rated HH tap airflow for FXMQ20P-125P.

- Improved ease of maintenance

- The drain pan can be detached for easy cleaning. An antibacterial treatment that uses silver ions has been applied to the drain pan, preventing the growth of slime, mould and bacteria that cause blockages and odours.

FXMQ200MA/FXMQ250MA



- Simplified Static Pressure Control
External static pressure can be easily adjusted using a change-over switch inside the electrical box to meet the resistance in the duct system.

- Built-in Drain Pump (Option)

Housing the drain pump inside the unit reduces the space required for installation.

- Without drain pump

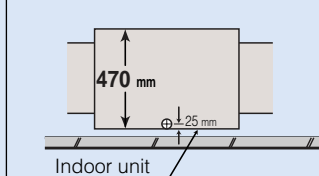

- With drain pump

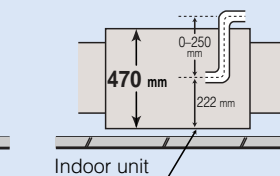

Indoor unit lineup

Ceiling Suspended Type

**FXHQ32MA/FXHQ63MA
FXHQ100MA**



Slim body with quiet and wide airflow

●Adoption of QUIET STREAM FAN

Uses the quiet stream fan and many more advanced technologies.

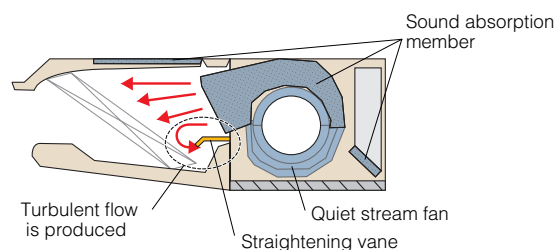

●Low operation sound level

FXHQ-MA	32	63	100
Sound level (H/L)	36/31	39/34	45/37

●Installation is easy

●Drain pump kit (option) can be easily incorporated.

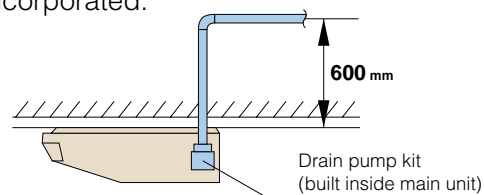

●Wide air discharge openings produce a spreading 100° airflow.

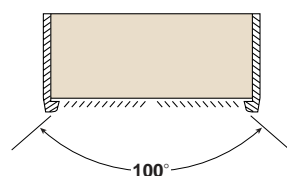

●Maintenance is easy

- Non-dew Flap with no implanted bristles
Bristle-free Flap minimises contamination and makes cleaning simpler.
- Easy-to-clean flat design
- Maintenance is easier because everything can be performed from below the unit.
- A long-life filter (maintenance free up to one year*) is equipped as standard accessory.

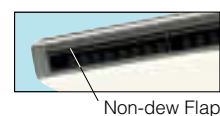

* 8 hr/day, 25 day/month. For dust concentration of 0.15 mg/m³

Wall Mounted Type

New
FXAQ20P/FXAQ25P
FXAQ32P/FXAQ40P
FXAQ50P/FXAQ63P



Stylish flat panel design harmonised with your interior décor

●Stylish flat panel design creates a graceful harmony that enhances any interior space.

●Flat panel can be cleaned with only the single pass of a cloth across their smooth surface. Flat panel can also be easily removed and washed for more thorough cleaning.

●Low operation sound level

FXAQ-P	20	25	32	40	50	63
Sound level (H/L)	35/31	36/31	38/31	39/34	42/37	47/41

●Drain pan and air filter can be kept clean by mould-proof polystyrene.

●Vertical auto-swing realises efficiency of air distribution. The louvre closes automatically when the unit stops.

●5 steps of discharge angle can be set by remote controller.

●Discharge angle is automatically set at the same angle as the previous operation when restarting. (Initial setting: 10° for cooling and 70° for heating)

●Flexible installation

●Drain pipe can be fitted to from either left or right sides.



●Drain pump kit is available as optional accessory, which lifts the drain 1,000 mm from the bottom of the unit.

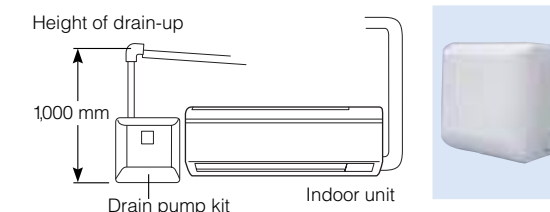

Indoor unit lineup

Floor Standing Type

FXLQ20MA/FXLQ25MA/FXLQ32MA
FXLQ40MA/FXLQ50MA/FXLQ63MA



Suitable for perimeter zone air conditioning

- Floor Standing types can be hung on the wall for easier cleaning. Running the piping from the back allows the unit to be hung on walls. Cleaning under the unit, where dust tends to accumulate, is considerably easier.
- The adoption of a fibre-less discharge grille featuring an original design to prevent condensation also helps prevent staining and makes cleaning easier.
- A long-life filter (maintenance free up to one year*) is equipped as standard accessory.

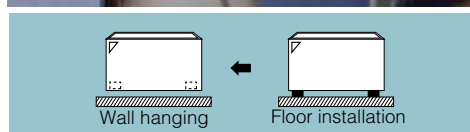

* 8 hr/day, 25 day/month. For dust concentration of 0.15 mg/m³

Concealed Floor Standing Type

FXNQ20MA/FXNQ25MA
FXNQ32MA/FXNQ40MA
FXNQ50MA/FXNQ63MA



Designed to be concealed in the perimeter skirting-wall

- The unit is concealed in skirting-wall of perimeter, that enables to create high class interior design.
- The connecting port faces downward, greatly facilitating on-site piping work.
- A long-life filter (maintenance free up to one year*) is equipped as standard accessory.

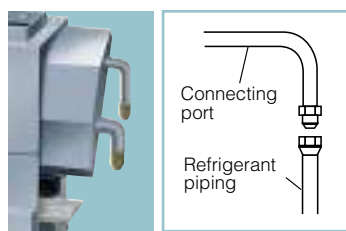

* Applies also to Floor Standing type (FXLQ-MA).



* 8 hr/day, 25 day/month. For dust concentration of 0.15 mg/m³

Connection unit series indoor units

Ceiling Suspended Cassette Type (50 Hz only)

FXUQ71MA/FXUQ100MA/
FXUQ125MA



This thin indoor unit achieves optimum air distribution, and can be installed without the need for ceiling cavity.

- Depending on installation site requirements or room conditions, 2-way, 3-way and 4-way discharge patterns are available.

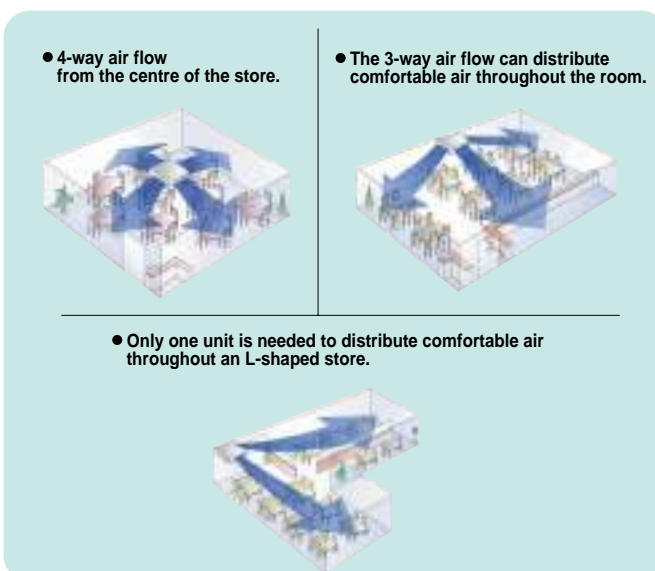

Connection unit Connection unit is the device for connecting above indoor unit to VRV-WIII.

BEVQ71MA/BEVQ100MA/BEVQ125MA

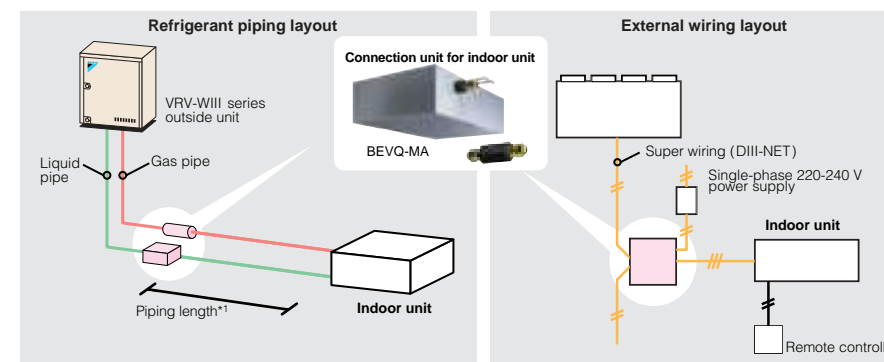

Model	Maximum piping length between the BEV unit and the indoor unit.
FXUQ-MA	5 m

- Notes:**
- When connecting centralised-control device, it is necessary to install an interface adaptor for an indoor unit (DTA102A52).
 - Connection unit BEVQ-MA is necessary for each indoor unit.
 - The refrigerant piping height difference between the indoor units and the BEV unit must be within 4 m.
 - The BEV unit must be installed within a maximum height difference between indoor units of 15 m.
 - Branching of the refrigerant piping is not possible downstream of the BEV unit.

Specifications

Ceiling Mounted Cassette (Round Flow) Type



MODEL		FXFQ25PVE	FXFQ32PVE	FXFQ40PVE	FXFQ50PVE	FXFQ63PVE	FXFQ80PVE	FXFQ100PVE	FXFQ125PVE	
Power supply		1-phase, 220-240 V/220 V, 50/60 Hz								
Cooling capacity	kcal/h (*1)	2,500	3,200	4,000	5,000	6,300	8,000	10,000	12,500	
	Btu/h (*1)	9,900	12,600	16,000	19,800	24,900	31,700	39,600	49,500	
	kW	(*1)	2.9	3.7	4.7	5.8	7.3	9.3	11.6	14.5
(*2)		2.8	3.6	4.5	5.6	7.1	9.0	11.2	14.0	
Heating capacity	kcal/h	2,800	3,400	4,300	5,400	6,900	8,600	10,800	13,800	
	Btu/h	10,900	13,600	17,100	21,500	27,300	34,100	42,700	54,600	
	kW	3.2	4.0	5.0	6.3	8.0	10.0	12.5	16.0	
Power consumption (50 Hz/60 Hz)	Cooling	kW	0.033/0.032	0.033/0.032	0.047/0.042	0.052/0.050	0.066/0.063	0.093/0.092	0.187/0.186	0.209/0.208
	Heating		0.027/0.027	0.027/0.027	0.034/0.034	0.038/0.038	0.053/0.053	0.075/0.075	0.174/0.174	0.200/0.200
Casing		Galvanised steel plate								
Airflow rate (HH/H/L)	m ³ /min	13/11.5/10	13/11.5/10	15/13/11	16/13.5/11	19/16.5/13.5	21/18/15	32/26/20	33/28/22.5	
	cfm	459/406/353	459/406/353	530/459/388	565/477/388	671/583/477	742/636/530	1,130/918/706	1,165/989/794	
Sound level (HH/H/L)	dB(A)	30/28.5/27	30/28.5/27	31/29/27	32/29.5/27	34/31/28	36/33.5/31	43/37.5/32	44/39/34	
Dimensions (HxWxD)	mm	246x840x840	246x840x840	246x840x840	246x840x840	246x840x840	246x840x840	288x840x840	288x840x840	
Machine weight	kg	19.5	19.5	19.5	19.5	22	22	25	25	
Piping connections	Liquid (Flare)	mm	φ 6.4	φ 6.4	φ 6.4	φ 6.4	φ 9.5	φ 9.5	φ 9.5	
	Gas (Flare)		φ 12.7	φ 12.7	φ 12.7	φ 12.7	φ 15.9	φ 15.9	φ 15.9	
	Drain		VP25 (External Dia, 32/Internal Dia, 25)							
Panel (Option)	Model	BYCP125K-W1								
	Colour	Fresh white								
	Dimensions (HxWxD)	mm	50X950X950	50X950X950	50X950X950	50X950X950	50X950X950	50X950X950	50X950X950	
	Weight	kg	5.5	5.5	5.5	5.5	5.5	5.5	5.5	

Ceiling Mounted Cassette (Double Flow) Type



MODEL		FXCQ20MVE	FXCQ25MVE	FXCQ32MVE	FXCQ40MVE	FXCQ50MVE	FXCQ63MVE	FXCQ80MVE	FXCQ125MVE	
Power supply		1-phase, 220-240 V/220 V, 50/60 Hz								
Cooling capacity	kcal/h (*1)	2,000	2,500	3,200	4,000	5,000	6,300	8,000	12,500	
	Btu/h (*1)	7,800	9,900	12,600	16,000	19,800	24,900	31,700	49,500	
	kW	(*1)	2.3	2.9	3.7	4.7	5.8	7.3	9.3	14.5
(*2)		2.2	2.8	3.6	4.5	5.6	7.1	9.0	14.0	
Heating capacity	kcal/h	2,200	2,800	3,400	4,300	5,400	6,900	8,600	13,800	
	Btu/h	8,500	10,900	13,600	17,100	21,500	27,300	34,100	54,600	
	kW	2.5	3.2	4.0	5.0	6.3	8.0	10.0	16.0	
Power consumption (50 Hz/60 Hz)	Cooling	kW	0.077/0.081	0.092/0.095	0.092/0.095	0.130/0.132	0.130/0.132	0.161/0.157	0.209/0.216	0.256/0.278
	Heating		0.044/0.048	0.059/0.062	0.059/0.062	0.097/0.099	0.097/0.099	0.126/0.124	0.176/0.183	0.223/0.245
Casing		Galvanised steel plate								
Airflow rate (H/L)	m ³ /min	7/5	9/6.5	9/6.5	12/9	12/9	16.5/13	26/21	33/25	
	cfm	247/177	318/230	318/230	424/318	424/318	582/459	918/741	1,165/883	
Sound level (H/L)	220 V	dB(A)	32/27	34/28	34/28	34/29	34/29	37/32	39/34	44/38
	240 V		34/29	36/30	36/30	37/32	37/32	39/34	41/36	46/40
Dimensions (HxWxD)	mm	305x775x600	305x775x600	305x775x600	305x990x600	305x990x600	305x1,175x600	305x1,665x600	305x1,665x600	
Machine weight	kg	26	26	26	31	32	35	47	48	
Piping connections	Liquid (Flare)	mm	φ 6.4	φ 6.4	φ 6.4	φ 6.4	φ 6.4	φ 9.5	φ 9.5	
	Gas (Flare)		φ 12.7	φ 12.7	φ 12.7	φ 12.7	φ 12.7	φ 15.9	φ 15.9	
	Drain		VP25 (External Dia, 32/Internal Dia, 25)							
Panel (Option)	Model	BYBC32G-W1		BYBC50G-W1		BYBC63G-W1		BYBC125G-W1		
	Colour	White (10Y9/0.5)								
	Dimensions (HxWxD)	mm	53x1,030x680	53x1,030x680	53x1,030x680	53x1,245x680	53x1,245x680	53x1,430x680	53x1,920x680	
	Weight	kg	8.0	8.0	8.0	8.5	8.5	9.5	12.0	

Ceiling Mounted Cassette (Compact Multi Flow) Type



MODEL		FXZQ20MVE	FXZQ25MVE	FXZQ32MVE	FXZQ40MVE	FXZQ50MVE	
Power supply		1-phase, 220-240 V/220 V, 50 Hz/60 Hz					
Cooling capacity	kcal/h (*1)	2,000	2,500	3,200	4,000	5,000	
	Btu/h (*1)	7,800	9,900	12,600	16,000	19,800	
	kW	(*1)	2.3	2.9	3.7	4.7	5.8
(*2)		2.2	2.8	3.6	4.5	5.6	
Heating capacity	kcal/h	2,200	2,800	3,400	4,300	5,400	
	Btu/h	8,500	10,900	13,600	17,100	21,500	
	kW	2.5	3.2	4.0	5.0	6.3	
Power consumption (50 Hz/60 Hz)	Cooling	kW	0.073/0.075	0.073/0.075	0.076/0.080	0.089/0.095	0.115/0.128
	Heating		0.064/0.069	0.064/0.069	0.068/0.073	0.080/0.088	0.107/0.122
Casing		Galvanised steel plate					
Airflow rate (H/L)	m ³ /min	9/7	9/7	9.5/7.5	11/8	14/10	
	cfm	318/247	318/247	335/265	388/282	493/353	
Sound level (H/L)	230 V, 50 Hz-240 V, 50 Hz-220 V, 60 Hz	dB(A)	30/25-32/26-32/29	30/25-32/26-32/29	32/26-34/28-33/29	36/28-37/29-36/30	41/33-42/35-41/34
Dimensions (HxWxD)	mm	286x575x575					
Machine weight	kg	18					
Piping connections	Liquid (Flare)	mm	φ 6.4	φ 6.4	φ 6.4	φ 6.4	
	Gas (Flare)		φ 12.7	φ 12.7	φ 12.7	φ 12.7	
	Drain		VP20 (External Dia, 26/Internal Dia, 20)				
Panel (Option)	Model	BYFQ60B8W1					
	Colour	White (6.5Y9.5/0.5)					
	Dimensions (HxWxD)	mm	55x700x700	55x700x700	55x700x700	55x700x700	55x700x700
	Weight	kg	2.7	2.7	2.7	2.7	2.7

Note: Specifications are based on the following conditions;

- Cooling: (*1) Indoor temp.: 27°CDB, 19.5°CWB/inlet water temp.: 30°C, Equivalent piping length: 7.5 m, Level difference: 0 m. (*2) Indoor temp.: 27°CDB, 19°CWB/inlet water temp.: 30°C, Equivalent piping length: 7.5 m, Level difference: 0 m.
- Heating: Indoor temp.: 20°CDB/inlet water temp.: 20°C, Equivalent piping length: 7.5 m, Level difference: 0 m.
- Capacity of indoor unit is only for reference. Actual capacity of indoor unit is based on the total capacity index. (See Engineering Data Book for details.)
- Sound level: (FXCQ-M) Anechoic chamber conversion value, measured at a point 1.5 m downward from the unit centre. During actual operation, these values are normally somewhat higher as a result of ambient conditions.

Ceiling Mounted Cassette Corner Type



MODEL		FXKQ25MAVE	FXKQ32MAVE	FXKQ40MAVE	FXKQ63MAVE	
Power supply		1-phase, 220-240 V/220 V, 50/60 Hz				
Cooling capacity	kcal/h (*1)	2,500	3,200	4,000	6,300	
	Btu/h (*1)	9,900	12,600	16,000	24,900	
	kW	(*1)	2.9	3.7	4.7	7.3
(*2)		2.8	3.6	4.5	7.1	
Heating capacity	kcal/h	2,800	3,400	4,300	6,900	
	Btu/h	10,900	13,600	17,100	27,300	
	kW	3.2	4.0	5.0	8.0	
Power consumption (50 Hz/60 Hz)	Cooling	kW	0.066/0.069	0.066/0.069	0.076/0.092	0.105/0.120
	Heating		0.046/0.049	0.046/0.049	0.056/0.072	0.085/0.100
Casing		Galvanised steel plate				
Airflow rate (H/L)	50 Hz	m ³ /min	11/9	11/9	13/10	18/15
		cfm	388/318	388/318	459/353	635/530
	60 Hz	m ³ /min	11/8.5	11/8.5	13/10	18/13
Sound level (H/L)	220 V 240 V	dB(A)	38/33	38/33	40/34	42/37
		cfm	40/35	40/35	42/36	44/39
Dimensions (HxWxD)	mm	215x1,110x710	215x1,110x710	215x1,110x710	215x1,310x710	
Machine weight	kg	31	31	31	34	
Piping connections	Liquid (Flare)	mm	φ 6.4	φ 6.4	φ 6.4	φ 9.5
	Gas (Flare)		φ 12.7	φ 12.7	φ 12.7	φ 15.9
	Drain		VP25 (External Dia, 32/Internal Dia, 25)			
Panel (Option)	Model	BYK45FJW1		BYK71FJW1		
	Colour	White (10Y9/0.5)				
	Dimensions (HxWxD)	mm	70x1,240x800	70x1,240x800	70x1,240x800	70x1,440x800
	Weight	kg	8.5	8.5	8.5	9.5

Note: Specifications are based on the following conditions;

- Cooling: (*1) Indoor temp.: 27°CDB, 19.5°CWB/inlet water temp.: 30°C, Equivalent piping length: 7.5 m, Level difference: 0 m. (*2) Indoor temp.: 27°CDB, 19°CWB/inlet water temp.: 30°C, Equivalent piping length: 7.5 m, Level difference: 0 m.
- Heating: Indoor temp.: 20°CDB/inlet water temp.: 20°C, Equivalent piping length: 7.5 m, Level difference: 0 m.
- Capacity of indoor unit is only for reference. Actual capacity of indoor unit is based on the total capacity index. (See Engineering Data Book for details.)
- Sound level: (FXKQ-M) Anechoic chamber conversion value, measured at a point 1.5 m downward from the unit centre. During actual operation, these values are normally somewhat higher as a result of ambient conditions.

Specifications

Slim Ceiling Mounted Duct Type

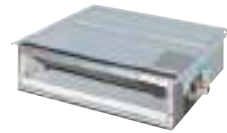

(700 mm width type)

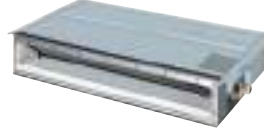

(900/1,100 mm width type)

MODEL	with drain pump	FXDQ20PBVE	FXDQ25PBVE	FXDQ32PBVE	FXDQ40NBVE	FXDQ50NBVE	FXDQ63NBVE	
	without drain pump	FXDQ20PBVET	FXDQ25PBVET	FXDQ32PBVET	FXDQ40NBVET	FXDQ50NBVET	FXDQ63NBVET	
Power supply	1-phase, 220-240 V/220 V, 50/60 Hz							
Cooling capacity	kcal/h (*1)	2,000	2,500	3,200	4,000	5,000	6,300	
	Btu/h (*1)	7,800	9,900	12,600	16,000	19,800	24,900	
	kW	(*1)	2.3	2.9	3.7	4.7	5.8	7.3
		(*2)	2.2	2.8	3.6	4.5	5.6	7.1
Heating capacity	kcal/h	2,200	2,800	3,400	4,300	5,400	6,900	
	Btu/h	8,500	10,900	13,600	17,100	21,500	27,300	
	kW		2.5	3.2	4.0	5.0	6.3	8.0
Power consumption (FXDQ-PBVE: 50 Hz/60 Hz)	Cooling	kW						
	Heating	kW						
Power consumption (FXDQ-PBVET: 50 Hz/60 Hz)	Cooling	kW						
	Heating	kW						
Casing	Galvanised steel plate							
Airflow rate (HH/H/L)	m ³ /min	8.0/7.2/6.4	8.0/7.2/6.4	8.0/7.2/6.4	10.5/9.5/8.5	12.5/11.0/10.0	16.5/14.5/13.0	
	cfm	282/254/226	282/254/226	282/254/226	371/335/300	441/388/353	583/512/459	
External static pressure	Pa	30-10 *1			44-15 *1			
Sound level (HH/H/L)*2*3	dB(A)	33/31/29	33/31/29	33/31/29	34/32/30	35/33/31	36/34/32	
Dimensions (H×W×D)	mm	200×700×620	200×700×620	200×700×620	200×900×620	200×900×620	200×1,100×620	
Machine weight	kg	23	23	23	27	28	31	
Piping connections	Liquid (Flare)	mm						
	Gas (Flare)	mm						
	Drain	mm						

Ceiling Mounted Duct Type



MODEL	FXMQ20PVE	FXMQ25PVE	FXMQ32PVE	FXMQ40PVE	FXMQ50PVE		
	Power supply	1-phase, 220-240 V/220 V, 50/60 Hz					
Cooling capacity	kcal/h (*1)	2,000	2,500	3,200	4,000	5,000	
	Btu/h (*1)	7,800	9,900	12,600	16,000	19,800	
	kW	(*1)	2.3	2.9	3.7	4.7	5.8
		(*2)	2.2	2.8	3.6	4.5	5.6
Heating capacity	kcal/h	2,200	2,800	3,400	4,300	5,400	
	Btu/h	8,500	10,900	13,600	17,100	21,500	
	kW		2.5	3.2	4.0	5.0	6.3
Power consumption (50 Hz/60 Hz)	Cooling	kW					
	Heating	kW					
Casing	Galvanised steel plate						
Airflow rate (HH/H/L)	m ³ /min	9/7.5/6.5	9/7.5/6.5	9.5/8/7	16/13/11	18/16.5/15	
	cfm	318/265/230	318/265/230	335/282/247	565/459/388	635/582/530	
External static pressure	Pa	30-100 *4		30-100 *4		50-200 *4	
Sound level (HH/H/L)	dB(A)	33/31/29	33/31/29	34/32/30	39/37/35	41/39/37	
Dimensions (H×W×D)	mm	300×550×700	300×550×700	300×550×700	300×700×700	300×1,000×700	
Machine weight	kg	25	25	25	28	36	
Piping connections	Liquid (Flare)	mm					
	Gas (Flare)	mm					
	Drain	mm					

Note: Specifications are based on the following conditions:
 •Cooling: (*1) Indoor temp.: 27°CDB, 19.5°CWB/inlet water temp.: 30°C, Equivalent piping length: 7.5 m, Level difference: 0 m.
 (*2) Indoor temp.: 27°CDB, 19°CWB/inlet water temp.: 30°C, Equivalent piping length: 7.5 m, Level difference: 0 m.
 •Heating: Indoor temp.: 20°CDB/inlet water temp.: 20°C, Equivalent piping length: 7.5 m, Level difference: 0 m.
 •Capacity of indoor unit is only for reference. Actual capacity of indoor unit is based on the total capacity index.
 (See Engineering Data Book for details.)
 •Sound level: Anechoic chamber conversion value, measured at a point 1.5 m downward from the unit centre.
 During actual operation, these values are normally somewhat higher as a result of ambient conditions.
 *1: External static pressure is changeable to set by the remote controller. This pressure means "High static pressure - Standard". (Factory setting is 10 Pa for FXDQ20-32PB, 15 Pa for FXDQ40-63NB)
 *2: The values of operation sound level represent those for rear-suction operation. Sound level values for bottom-suction operation can be obtained by adding 5 dB(A).
 *3: Values are based on the following conditions: external static pressure of 10 Pa for FXDQ20-32PB, 15 Pa for FXDQ40-63NB.
 *4: External static pressure can be modified using a remote controller that offers seven (FXMQ20-32P), thirteen (FXMQ40P), fourteen (FXMQ50P) levels of control. These values indicate the lowest and highest possible static pressures. The standard static pressure is 50 Pa for FXMQ20-32P and 100 Pa for FXMQ40-50P.

Ceiling Mounted Duct Type



MODEL	FXMQ63PVE	FXMQ80PVE	FXMQ100PVE	FXMQ125PVE	FXMQ140PVE		
	Power supply	1-phase, 220-240 V/220 V, 50/60 Hz					
Cooling capacity	kcal/h (*1)	6,300	8,000	10,000	12,500	14,300	
	Btu/h (*1)	24,900	31,700	39,600	49,500	57,000	
	kW	(*1)	7.3	9.3	11.6	14.5	16.7
		(*2)	7.1	9.0	11.2	14.0	16.0
Heating capacity	kcal/h	6,900	8,600	10,800	13,800	15,500	
	Btu/h	27,300	34,100	42,700	54,600	61,400	
	kW		8.0	10.0	12.5	16.0	18.0
Power consumption (50 Hz/60 Hz)	Cooling	kW					
	Heating	kW					
Casing	Galvanised steel plate						
Airflow rate (HH/H/L)	m ³ /min	19.5/17.5/16	25/22.5/20	32/27/23	39/33/28	46/39/32	
	cfm	688/618/565	883/794/706	1,130/953/812	1,377/1,165/988	1,624/1,377/1,130	
External static pressure	Pa	50-200 *1		50-200 *1			
Sound level (HH/H/L)	dB(A)	42/40/38	43/41/39	43/41/39	44/42/40	46/45/43	
Dimensions (H×W×D)	mm	300×1,000×700	300×1,000×700	300×1,400×700	300×1,400×700	300×1,400×700	
Machine weight	kg	36	36	46	46	47	
Piping connections	Liquid (Flare)	mm					
	Gas (Flare)	mm					
	Drain	mm					

Ceiling Mounted Duct Type



MODEL	FXMQ200MAVE	FXMQ250MAVE		
	Power supply	1-phase, 220-240 V/220 V, 50/60 Hz		
Cooling capacity	kcal/h (*1)	19,800	24,800	
	Btu/h (*1)	78,500	98,300	
	kW	(*1)	23.0	28.8
		(*2)	22.4	28.0
Heating capacity	kcal/h	21,500	27,100	
	Btu/h	85,300	107,500	
	kW		25.0	31.5
Power consumption (50 Hz/60 Hz)	Cooling	kW		
	Heating	kW		
Casing	Galvanised steel plate			
Airflow rate (H/L)	m ³ /min	58/50	72/62	
	cfm	2,047/1,765	2,542/2,189	
External static pressure	50 Hz	Pa		
	60 Hz	Pa		
Sound level (H/L)	220 V	dB(A)		
	240 V	dB(A)		
Dimensions (H×W×D)	mm	470×1,380×1,100	470×1,380×1,100	
Machine weight	kg	137	137	
Piping connections	Liquid (Flare)	mm		
	Gas (Brazing)	mm		
	Drain	mm		

Note: Specifications are based on the following conditions:
 •Cooling: (*1) Indoor temp.: 27°CDB, 19.5°CWB/inlet water temp.: 30°C, Equivalent piping length: 7.5 m, Level difference: 0 m.
 (*2) Indoor temp.: 27°CDB, 19°CWB/inlet water temp.: 30°C, Equivalent piping length: 7.5 m, Level difference: 0 m.
 •Heating: Indoor temp.: 20°CDB/inlet water temp.: 20°C, Equivalent piping length: 7.5 m, Level difference: 0 m.
 •Capacity of indoor unit is only for reference. Actual capacity of indoor unit is based on the total capacity index.
 (See Engineering Data Book for details.)
 •Sound level: Anechoic chamber conversion value, measured at a point 1.5 m downward from the unit centre.
 During actual operation, these values are normally somewhat higher as a result of ambient conditions.
 *1: External static pressure can be modified using a remote controller that offers fourteen (FXMQ63-125P) or ten (FXMQ140P) levels of control. These values indicate the lowest and highest possible static pressures. The standard static pressure is 100 Pa.
 *2: External static pressure is changeable to change over the connectors inside electrical box, this pressure means "Standard-High static pressure".

Specifications

Ceiling Suspended Type



MODEL		FXHQ32MAVE	FXHQ63MAVE	FXHQ100MAVE
Power supply		1-phase, 220-240 V/220 V, 50/60 Hz		
Cooling capacity	kcal/h (*1)	3,200	6,300	10,000
	Btu/h (*1)	12,600	24,900	39,600
	kW	(*1)	3.7	7.3
(*2)		3.6	7.1	11.2
Heating capacity	kcal/h	3,400	6,900	10,800
	Btu/h	13,600	27,300	42,700
	kW	4.0	8.0	12.5
Power consumption (50 Hz/60 Hz)	Cooling	0.111/0.142	0.115/0.145	0.135/0.199
	Heating			
Casing		White (10Y9/0.5)		
Airflow rate (H/L)	m ³ /min	12/10	17.5/14	25/19.5
	cfm	424/353	618/494	883/688
Sound level (H/L)	dB(A)	36/31	39/34	45/37
Dimensions (H×W×D)	mm	195×960×680	195×1,160×680	195×1,400×680
Machine weight	kg	24	28	33
Piping connections	Liquid (Flare)	φ 6.4	φ 9.5	φ 9.5
	Gas (Flare)	φ 12.7	φ 15.9	φ 15.9
	Drain	VP20 (External Dia, 26/Internal Dia, 20)		

Floor Standing Type/Concealed Floor Standing Type



FXLQ

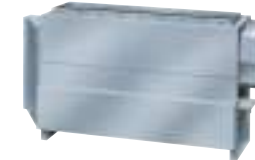

FXNQ

MODEL		FXLQ20MAVE	FXLQ25MAVE	FXLQ32MAVE	FXLQ40MAVE	FXLQ50MAVE	FXLQ63MAVE	
		FXNQ20MAVE	FXNQ25MAVE	FXNQ32MAVE	FXNQ40MAVE	FXNQ50MAVE	FXNQ63MAVE	
Power supply		1-phase, 220-240 V/220 V, 50/60 Hz						
Cooling capacity	kcal/h (*1)	2,000	2,500	3,200	4,000	5,000	6,300	
	Btu/h (*1)	7,800	9,900	12,600	16,000	19,800	24,900	
	kW	(*1)	2.3	2.9	3.7	4.7	5.8	7.3
		(*2)	2.2	2.8	3.6	4.5	5.6	7.1
Heating capacity	kcal/h	2,200	2,800	3,400	4,300	5,400	6,900	
	Btu/h	8,500	10,900	13,600	17,100	21,500	27,300	
	kW	2.5	3.2	4.0	5.0	6.3	8.0	
Power consumption (50 Hz/60 Hz)	Cooling	0.049/0.047	0.049/0.047	0.090/0.079	0.090/0.084	0.110/0.105	0.110/0.108	
	Heating							
Casing		FXLQ: Ivory white (5Y7.5/1)/FXNQ: Galvanised steel plate						
Airflow rate (H/L)	m ³ /min	7/6	7/6	8/6	11/8.5	14/11	16/12	
	cfm	247/212	247/212	282/212	388/300	494/388	565/424	
Sound level (H/L)	220 V	dB(A)	35/32	35/32	35/32	38/33	39/34	
	240 V		37/34	37/34	37/34	40/35	41/36	
Dimensions (H×W×D)	FXLQ	mm	600×1,000×222	600×1,000×222	600×1,140×222	600×1,140×222	600×1,420×222	
	FXNQ		610×930×220	610×930×220	610×1,070×220	610×1,070×220	610×1,350×220	
Machine weight	FXLQ	kg	25	25	30	30	36	
	FXNQ		19	19	23	23	27	
Piping connections	Liquid (Flare)	mm	φ 6.4	φ 6.4	φ 6.4	φ 6.4	φ 9.5	
	Gas (Flare)		φ 12.7	φ 12.7	φ 12.7	φ 12.7	φ 15.9	
	Drain		210.D.					

Note: Specifications are based on the following conditions:
 •Cooling: (*1) Indoor temp.: 27°CDB, 19.5°CWB/inlet water temp.: 30°C, Equivalent piping length: 7.5 m, Level difference: 0 m.
 (*2) Indoor temp.: 27°CDB, 19°CWB/inlet water temp.: 30°C, Equivalent piping length: 7.5 m, Level difference: 0 m.
 •Heating: Indoor temp.: 20°CDB/inlet water temp.: 20°C, Equivalent piping length: 7.5 m, Level difference: 0 m.
 •Capacity of indoor unit is only for reference. Actual capacity of indoor unit is based on the total capacity index.
 (See Engineering Data Book for details.)
 •Sound level: Anechoic chamber conversion value, measured at a point 1.5 m downward from the unit centre.
 During actual operation, these values are normally somewhat higher as a result of ambient conditions.

Wall Mounted Type



MODEL		FXAQ20PVE	FXAQ25PVE	FXAQ32PVE	FXAQ40PVE	FXAQ50PVE	FXAQ63PVE
Power supply		1-phase, 220-240 V/220 V, 50/60 Hz					
Cooling capacity	kcal/h (*1)	2,000	2,500	3,200	4,000	5,000	6,300
	Btu/h (*1)	7,800	9,900	12,600	16,000	19,800	24,900
	kW	(*1)	2.3	2.9	3.7	4.7	5.8
(*2)		2.2	2.8	3.6	4.5	5.6	7.1
Heating capacity	kcal/h	2,200	2,800	3,400	4,300	5,400	6,900
	Btu/h	8,500	10,900	13,600	17,100	21,500	27,300
	kW	2.5	3.2	4.0	5.0	6.3	8.0
Power consumption	Cooling	0.019	0.028	0.030	0.020	0.033	0.050
	Heating						
Casing		White (3.0Y8.5/0.5)					
Airflow rate (H/L)	m ³ /min	7.5/4.5	8/5	8.5/5.5	12/9	15/12	19/14
	cfm	265/159	282/177	300/194	424/318	530/424	671/494
Sound level (H/L)	dB(A)	35/31	36/31	38/31	39/34	42/37	47/41
Dimensions (H×W×D)	mm	290×795×238	290×795×238	290×795×238	290×1,050×238	290×1,050×238	290×1,050×238
Machine weight	kg	11	11	11	14	14	14
Piping connections	Liquid (Flare)	φ 6.4	φ 6.4	φ 6.4	φ 6.4	φ 6.4	φ 9.5
	Gas (Flare)	φ 12.7	φ 12.7	φ 12.7	φ 12.7	φ 12.7	φ 15.9
	Drain	VP13 (External Dia, 18/Internal Dia, 13)					

Note: Specifications are based on the following conditions:
 •Cooling: (*1) Indoor temp.: 27°CDB, 19.5°CWB/inlet water temp.: 30°C, Equivalent piping length: 7.5 m, Level difference: 0 m.
 (*2) Indoor temp.: 27°CDB, 19°CWB/inlet water temp.: 30°C, Equivalent piping length: 7.5 m, Level difference: 0 m.
 •Heating: Indoor temp.: 20°CDB/inlet water temp.: 20°C, Equivalent piping length: 7.5 m, Level difference: 0 m.
 •Capacity of indoor unit is only for reference. Actual capacity of indoor unit is based on the total capacity index.
 (See Engineering Data Book for details.)
 •Sound level: Anechoic chamber conversion value, measured at a point 1 m in front of the unit and 1 m downward.
 During actual operation, these values are normally somewhat higher as a result of ambient conditions.

Specifications

Connection unit series indoor units (50 Hz only)

- * A type of BEV unit is necessary for each Connection unit series indoor unit. Refer to the Engineering Data for details.
- * If indoor units from the Connection unit series are connected within a single refrigerant system to indoor units from any other series, cooling/heating switchover will not be possible using the remote controller of the Connection unit series indoor units. However, if the remote controller of an indoor unit from the other series is set as a master remote controller, cooling/heating switchover will be possible.
- * If all indoor units are from the Connection unit series, an outside unit Cool/Heat selector will be needed to enable cooling/heating switchover.
- * If connecting to the BS unit within a Heat Recovery system, switching between cooling and heating is possible from remote controller (only for FXUQ-MA).
- * Group control between Connection Unit series equipment within one system is possible. However, group control with the other VRV indoor units is not possible.

Ceiling Suspended Cassette Type



Model	Indoor unit		FXUQ71MAV1	FXUQ100MAV1	FXUQ125MAV1			
	Connection unit		BEVQ71MAVE	BEVQ100MAVE	BEVQ125MAVE			
Power supply			1-phase, 220-240 V, 50 Hz					
Cooling capacity			Kcal/h(*1)	7,100	10,000	12,500		
			Btu/h(*1)	28,300	39,600	49,500		
			kW	(*1)	8.3	11.6	14.5	
				(*2)	8.0	11.2	14.0	
Heating capacity (Max.)			Kcal/h	7,700	10,800	12,000		
			Btu/h	30,700	42,700	47,800		
			kW	9.0	12.5	14.0		
Power consumption			Cooling	0.189	0.298	0.298		
			Heating	0.169	0.278	0.278		
Indoor unit			Casing			White(10Y9/0.5)		
			Airflow rate (H/L)		m ³ /min	19/14	29/21	32/23
					cfm	671/494	1,024/741	1,130/812
			Sound level	230 V	dB (A)	40/35	43/38	44/39
			Dimensions (HxWxD)		mm	165x895x895	230x895x895	230x895x895
Machine weight		kg	25	31	31			
Piping connections			Liquid	φ 9.5 (Flare)				
			Gas	φ 15.9 (Flare)				
			Drain	VP 20 (External Dia. 26/Internal Dia. 20)				

Note: Specifications are based on the following conditions :

- Cooling: (*1) Indoor temp.: 27°CDB, 19.5°CWB/inlet water temp.: 30°C, Equivalent piping length: 7.5 m, Level difference: 0 m. (*2) Indoor temp.: 27°CDB, 19°CWB/inlet water temp.: 30°C, Equivalent piping length: 7.5 m, Level difference: 0 m.
- Heating: Indoor temp.: 20°CDB/inlet water temp.: 20°C, Equivalent piping length: 7.5 m, Level difference: 0 m.
- Capacity of indoor unit is only for reference. Actual capacity of indoor unit is based on the total capacity index. (See Engineering Data Book for details.)
- Sound level: Anechoic chamber conversion value, measured at a point 1.5 m below the unit centre. During actual operation, these values are normally somewhat higher as a result of ambient conditions.

OUTSIDE UNITS

Heat Pump/Heat Recovery

MODEL	50 Hz		RWEYQ8PY1	RWEYQ10PY1	RWEYQ16PY1	RWEYQ18PY1	RWEYQ20PY1					
	60 Hz		—	RWEYQ10PYL	—	—	RWEYQ20PYL					
	Combination units (50 Hz)		—	RWEYQ10PTL	—	—	RWEYQ20PTL					
Combination units (60 Hz)		—	—	RWEYQ8PY1	RWEYQ8PY1	RWEYQ10PY1	RWEYQ10PY1					
Combination units (60 Hz)		—	—	—	—	—	RWEYQ10PYL/TL					
Combination units (60 Hz)		—	—	—	—	—	RWEYQ10PYL/TL					
Power supply			Y1: 3-phase 4-wire system, 380-415 V, 50 Hz YL: 3-phase 4-wire system, 380 V, 60 Hz TL: 3-phase 3-wire system, 220 V, 60 Hz									
Cooling capacity (*1)(*2)			kcal/h(*1)	19,500	23,200	39,000	42,700	46,400				
			Btu/h(*1)	77,500	92,100	155,000	170,000	184,000				
			kW	22.7	27.0	45.4	49.7	54.0				
Heating capacity			kW	22.4	26.7	44.8	49.1	53.4				
			kcal/h	21,500	27,100	43,000	48,600	54,200				
			Btu/h	85,300	107,000	171,000	193,000	215,000				
Power consumption			Cooling (*2)	kW	4.54	6.03	9.09	10.6	12.1			
			Heating	kW	4.24	6.05	8.49	10.3	12.1			
Casing colour			Ivory white (5Y7.5/1)									
Dimensions (H x W x D)			mm		1,000 x 780 x 550			(1,000 x 780 x 550) x 2				
Compressor			Type					Hermetically sealed scroll type				
Refrigerant piping connections			Motor output		kW	4.0	4.2	4.0 x 2	4.0 + 4.2	4.2 x 2		
Liquid			Suction gas*1		mm	φ9.5 (Flare)		φ12.7 (Flare)		φ15.9 (Flare)		
			High and low pressure gas		mm		φ19.1 (Brazing)		φ22.2 (Brazing)		φ28.6 (Brazing)	
Water piping connections			Water inlet		PT1 1/4B internal thread		(PT1 1/4B) x 2 internal thread		(PT1 1/4B) x 2 internal thread			
			Water outlet		PT1 1/4B internal thread		(PT1 1/4B) x 2 internal thread		(PT1 1/4B) x 2 internal thread			
Machine weight (Operating weight)			kg		149 (151)	150 (152)	149 + 149 (151 + 151)	149 + 150 (151 + 152)	150 + 150 (152 + 152)			
			Sound level		dB(A)	50	51	53	54			
Operation range (Inlet water temp.)			°C					10 to 45				
Capacity control			%					23-100	11-100			
Refrigerant			Type					R-410A				
Charge			kg					3.5	4.2	3.5 + 3.5	3.5 + 4.2	4.2 + 4.2

MODEL	50 Hz		RWEYQ24PY1	RWEYQ26PY1	RWEYQ28PY1	RWEYQ30PY1				
	60 Hz		—	—	—	RWEYQ30PYL				
	Combination units (50 Hz)		RWEYQ8PY1	RWEYQ8PY1	RWEYQ8PY1	RWEYQ10PY1				
Combination units (60 Hz)		RWEYQ8PY1	RWEYQ8PY1	RWEYQ10PY1	RWEYQ10PY1					
Combination units (60 Hz)		—	—	—	RWEYQ10PYL/TL					
Combination units (60 Hz)		—	—	—	RWEYQ10PYL/TL					
Power supply			Y1: 3-phase 4-wire system, 380-415 V, 50 Hz YL: 3-phase 4-wire system, 380 V, 60 Hz TL: 3-phase 3-wire system, 220 V, 60 Hz							
Cooling capacity (*1)(*2)			kcal/h(*1)	58,600	62,300	66,000	69,700			
			Btu/h(*1)	232,000	247,000	262,000	276,000			
			kW	68.1	72.4	76.7	81.0			
Heating capacity			kW	67.2	71.5	75.8	80.1			
			kcal/h	64,500	70,100	75,700	81,300			
			Btu/h	256,000	278,000	300,000	322,000			
Power consumption			Cooling (*2)	kW	13.6	15.1	16.6	18.1		
			Heating	kW	12.7	14.5	16.3	18.2		
Casing colour			Ivory white (5Y7.5/1)							
Dimensions (H x W x D)			mm				(1,000 x 780 x 550) x 3			
Compressor			Type				Hermetically sealed scroll type			
Refrigerant piping connections			Motor output		kW	4.0 x 3	4.0 x 2 + 4.2	4.0 + 4.2 x 2	4.2 x 3	
Liquid			Suction gas*1		mm	φ15.9 (Flare)		φ19.1 (Flare)		
			High and low pressure gas		mm		φ34.9 (Brazing)		φ28.6 *2, φ34.9 *3 (Brazing)	
Water piping connections			Water inlet		(PT1 1/4B) x 3 internal thread		(PT1 1/4B) x 3 internal thread			
			Water outlet		(PT1 1/4B) x 3 internal thread		(PT1 1/4B) x 3 internal thread			
Machine weight (Operating weight)			kg		149 + 149 + 149 (151 + 151 + 151)	149 + 149 + 150 (151 + 151 + 152)	149 + 150 + 150 (151 + 152 + 152)	150 + 150 + 150 (152 + 152 + 152)		
			Sound level		dB(A)	55	56			
Operation range (Inlet water temp.)			°C				10 to 45			
Capacity control			%				8-100			
Refrigerant			Type				R-410A			
Charge			kg				3.5 + 3.5 + 3.5	3.5 + 3.5 + 4.2	3.5 + 4.2 + 4.2	4.2 + 4.2 + 4.2

- Note: 1. Specifications are based on the following conditions :
- Cooling: (*1) Indoor temp.: 27°CDB, 19.5°CWB/inlet water temp.: 30°C, Equivalent piping length: 7.5 m, Level difference: 0 m. (*2) Indoor temp.: 27°CDB, 19°CWB/inlet water temp.: 30°C, Equivalent piping length: 7.5 m, Level difference: 0 m.
 - Heating: Indoor temp.: 20°CDB/inlet water temp.: 20°C, Equivalent piping length: 7.5 m, Level difference: 0 m.
2. *1. In the case of heat pump system, suction gas pipe is not used.
 *2. In the case of heat recovery system.
 *3. In the case of heat pump system.
 3. This unit cannot be installed in the outdoors. Install indoors (Machine room, etc).
 4. Hold ambient temperature at 0-40°C and humidity at 80%RH or less.
 Heat rejection from the casing: 0.64 kW/8 HP, 0.71 kW/10 HP.
 5. Connectable to closed type cooling tower only.

•Be sure to refer to the Engineering Data Book for facility design.

Specifications

BS UNITS FOR HEAT RECOVERY

BS Unit



MODEL		50 Hz		60 Hz		
		BSVQ100PV1	BSVQ160PV1	BSVQ36PVJU	BSVQ60PVJU	BSVQ250PV1
Power supply		V1: 1-phase, 220-240 V, 50 Hz, VJU: 1-phase, 208-230 V, 60 Hz				
No. of branches		1				
Total capacity index of connectable indoor units		20 to 100	More than 100 but 160 or less	More than 160 but 250 or less		
No. of connectable indoor units		Max. 5	Max. 8	Max. 8		
Casing		Galvanised steel plate				
Dimensions (H×W×D)		mm 207×388×326				
Refrigerant piping connections	Indoor unit	Liquid	mm φ 9.5 (Brazing)*1	φ 9.5 (Brazing)	φ 9.5 (Brazing)	
		Gas	φ 15.9 (Brazing)*1	φ 15.9 (Brazing)*2	φ 22.2 (Brazing)*3	
	Outside unit	Liquid	φ 9.5 (Brazing)	φ 9.5 (Brazing)	φ 9.5 (Brazing)	
		Suction gas	mm φ 15.9 (Brazing)	φ 15.9 (Brazing)*2	φ 22.2 (Brazing)*3	
	High and low pressure gas	φ 12.7 (Brazing)	φ 12.7 (Brazing)*2	φ 19.1 (Brazing)*3		
Machine weight		kg	12	12	15	
Sound level		dB(A)	42 (32)*4	43 (32)*4	44 (34)*4	

- Notes: ★1 When connecting with an indoor unit with a capacity index between 20 and 50, connect the attached pipe to the field pipe. (Brazing the connection between the attached and field pipe.)
 ★2 When connecting with indoor units with total capacity indexes between 150 and 160, connect the attached pipe to the field pipe. (Brazing the connection between the attached and field pipe.)
 ★3 When connecting with indoor units with a capacity index of 200, or with total capacity indexes between 160 and 200, connect the attached pipe to the field pipe. (Brazing the connection between the attached and field pipe.)
 ★4 Figures in brackets () indicate sound levels when the all indoor units connected to the BS unit are not operating but other indoor units within the same system are operating.

Centralised BS Unit (50 Hz only)



MODEL		BSV4Q100PV1		BSV6Q100PV1	
		Power supply		1-phase, 220-240 V, 50 Hz	
No. of branches		4		6	
Capacity index of connectable indoor units per branch		Max. 100			
No. of connectable indoor units per branch		Max. 5			
Casing		Galvanised steel plate			
Dimensions (H×W×D)		mm 209 × 1,053 × 635		209 × 1,577 × 635	
Refrigerant piping connections	Indoor unit	Liquid	mm φ 9.5 (Brazing)*1	φ 9.5 (Brazing)*1	
		Gas	φ 15.9 (Brazing)*1	φ 15.9 (Brazing)*1	
	Outside unit	Liquid	φ 12.7 (Brazing)*2	φ 15.9 (Brazing)*2	
		Suction gas	mm φ 28.6 (Brazing)*2	φ 28.6 (Brazing)*2	
	High and low pressure gas	φ 19.1 (Brazing)*2	φ 28.6 (Brazing)*2		
Machine weight		kg	60	89	
Sound level		dB(A)	48 (38)*3	50 (40)*3	

- Notes: ★1 When connecting with an indoor unit with a capacity index between 20 and 50, connect the attached pipe to the field pipe. (Brazing connection between the attached and field pipe.)
 ★2 Reducer may be required (obtain locally) if joint diameter does not fit on the triple piping side. Insulators are necessary (obtain locally) for piping connections on the outside unit side.
 ★3 Figures in brackets () indicate sound levels when the all indoor units connected to the BS unit are not operating but other indoor units within the same system are operating.
 • Must be installed in locations where the noise generated by the BS unit does not cause any problem.
 • Make sure to connect the closed pipe kit (KHFP26A100C) to branch not connected for the indoor unit. Closed pipe kit (option) can be used for only one branch in each unit, and up to two branches in one refrigerant circuit.

Option List

INDOOR UNITS

Ceiling Mounted Cassette (Round Flow) Type

No.	Item	Type	FXFQ25P	FXFQ32P	FXFQ40P	FXFQ50P	FXFQ63P	FXFQ80P	FXFQ100P	FXFQ125P	
1	Decoration panel		BYCP125K-W1								
2	Sealing member of air discharge outlet		KDBH55K160F								
3	Panel spacer		KDBP55H160FA								
4	Filter related	High efficiency filter unit 65%	KAFP556B80				KAFP557B160		KAFP552B160		KAFP553B160
		High efficiency filter unit 90%	KAFP557B80				KAFP557B160		KAFP552B160		KAFP553B160
		Replacement high efficiency filter 65%	KAFP552B80				KAFP552B160		KAFP552B160		KAFP553B160
		Replacement high efficiency filter 90%	KAFP553B80				KAFP553B160		KAFP553B160		KAFP553B160
		Filter chamber	KDDFP55B160				KDDFP55B160		KDDFP55B160		KDDFP55B160
		Long life replacement filter Non-woven type	KAFP551K160				KAFP551K160		KAFP551K160		KAFP551K160
5	Fresh air intake kit	Ultra long-life filter	KAFP55B160								
		Replacement ultra long-life filter	KAFP55H160H								
		Chamber type Without T shape and fan	KDDP55B160				KDDP55B160K		KDDP55X160		KDDP55X160
		Chamber type With T shape without fan	KDDP55B160				KDDP55B160K		KDDP55X160		KDDP55X160
	Direct installation type	KDDP55X160									
6	Branch duct chamber		KDJP55B80				KDJP55B160		KDJP55B160		
7	Chamber connection kit		KKSJ55KA160								
8	Insulation kit for high humidity		KDTP55K80				KDTP55K160		KDTP55K160		

Ceiling Mounted Cassette (Compact Multi Flow) Type

No.	Item	Type	FXZQ20M	FXZQ25M	FXZQ32M	FXZQ40M	FXZQ50M
1	Decoration panel		BYFQ60B8W1				
2	Sealing member of air discharge outlet		KDBH44BA60				
3	Panel spacer		KDBQ44BA60A				
4	Replacement long-life filter		KAFQ441BA60				
5	Fresh air intake kit	Direct installation type	KDDQ44XA60				

Ceiling Mounted Cassette (Double Flow) Type

No.	Item	Type	FXCQ20M FXCQ25M FXCQ32M	FXCQ40M	FXCQ50M	FXCQ63M	FXCQ80M	FXCQ125M
1	Decoration panel		BYBC32G-W1	BYBC50G-W1	BYBC63G-W1	BYBC125G-W1	BYBC125G-W1	BYBC125G-W1
2	Filter related	High efficiency filter 65%*1	KAFJ532G36	KAFJ532G56	KAFJ532G80	KAFJ532G160	KAFJ532G160	KAFJ532G160
		High efficiency filter 90%*1	KAFJ533G36	KAFJ533G56	KAFJ533G80	KAFJ533G160	KAFJ533G160	KAFJ533G160
		Filter chamber bottom suction	KDDFJ53G36	KDDFJ53G56	KDDFJ53G80	KDDFJ53G160	KDDFJ53G160	KDDFJ53G160
		Long life replacement filter	KAFJ531G36	KAFJ531G56	KAFJ531G80	KAFJ531G160	KAFJ531G160	KAFJ531G160

Note: ★1 Filter chamber is required if installing high efficiency filter.

Ceiling Mounted Cassette Corner Type

No.	Item	Type	FXKQ25MA	FXKQ32MA	FXKQ40MA	FXKQ63MA
1	Panel related	Decoration panel	BYK45FJW1			
		Panel spacer	KPBJ52F56W			
2	Air inlet and air discharge outlet related	Long life replacement filter	KAFJ521F56			
		Air discharge grille	K-HV7AW			
		Air discharge blind panel	KDBJ52F56W			
		Flexible duct (with shutter)	KFDJ52FA56			

Slim Ceiling Mounted Duct Type (700 mm width type)

No.	Item	Type	FXDQ20PB	FXDQ25PB	FXDQ32PB
1	Insulation kit for high humidity		KDT25N32		

Slim Ceiling Mounted Duct Type (900/1,100 mm width type)

No.	Item	Type	FXDQ40NB	FXDQ50NB	FXDQ63NB
1	Insulation kit for high humidity		KDT25N50		

Option List

INDOOR UNITS

Ceiling Mounted Duct Type

No.	Item	Type	FXMQ20P FXMQ25P FXMQ32P	FXMQ40P	FXMQ50P FXMQ63P FXMQ80P	FXMQ100P FXMQ125P FXMQ140P	FXMQ200MA FXMQ250MA
1	Drain pump kit		—				KDU30L250VE
2	High efficiency filter	65%	KAF372AA36	KAF372AA56	KAF372AA80	KAF372AA160	KAFJ372L280
		90%	KAF373AA36	KAF373AA56	KAF373AA80	KAF373AA160	KAFJ373L280
3	Filter chamber		KDDF37AA36	KDDF37AA56	KDDF37AA80	KDDF37AA160	KDJ3705L280
4	Long life replacement filter		KAF371AA36	KAF371AA56	KAF371AA80	KAF371AA160	KAFJ371L280
5	Long life filter chamber kit		KAF375AA36	KAF375AA56	KAF375AA80	KAF375AA160	—
6	Service panel	White	KTBJ25K36W	KTBJ25K56W	KTBJ25K80W	KTBJ25K160W	—
		Fresh white	KTBJ25K36F	KTBJ25K56F	KTBJ25K80F	KTBJ25K160F	
		Brown	KTBJ25K36T	KTBJ25K56T	KTBJ25K80T	KTBJ25K160T	
7	Air discharge adaptor		KDAJ25K36A	KDAJ25K56A	KDAJ25K71A	KDAJ25K140A	

Ceiling Suspended Type

No.	Item	Type	FXHQ32MA	FXHQ63MA	FXHQ100MA
1	Drain pump kit		KDU50N60VE	KDU50N125VE	
2	Replacement long-life filter (Resin net)		KAF501DA56	KAF501DA80	KAF501DA112
3	L-type piping kit (for upward direction)		KHFP5MA63	KHFP5MA160	

Wall Mounted Type

No.	Item	Type	FXAQ20P	FXAQ25P	FXAQ32P	FXAQ40P	FXAQ50P	FXAQ63P
1	Drain pump kit		K-KDU572EVE					

Floor Standing Type

No.	Item	Type	FXLQ20MA	FXLQ25MA	FXLQ32MA	FXLQ40MA	FXLQ50MA	FXLQ63MA
1	Long life replacement filter		KAFJ361K28		KAFJ361K45		KAFJ361K71	

Concealed Floor Standing Type

No.	Item	Type	FXNQ20MA	FXNQ25MA	FXNQ32MA	FXNQ40MA	FXNQ50MA	FXNQ63MA
1	Long life replacement filter		KAFJ361K28		KAFJ361K45		KAFJ361K71	

Ceiling Suspended Cassette Type

No.	Item	Type	FXUQ71MA	FXUQ100MA	FXUQ125MA
1	Replacement long-life filter		KAF495FA140		
2	Sealing member of air discharge outlet (*1)		KDBH49FA80	KDBH49FA140	
3	Decoration panel for air discharge		KDBT49FA80	KDBT49FA140	
4	Vertical flap kit		KDGJ49FA80	KDGJ49FA140	
5	L-shape piping kit		KHFP49MA140		

Note: (*1): This option is necessary for setting up 2-way (opposing directional) airflow when the air conditioner is installed.

OUTSIDE UNITS

No.	Item	Type	RWEYQ8P RWEYQ10P	RWEYQ16P RWEYQ18P RWEYQ20P	RWEYQ24P RWEYQ26P RWEYQ28P RWEYQ30P
1	Cool/heat selector		KRC19-26A		
1-1	Fixing box		KJB111A		
2	Distributive piping	REFNET header	KHRP25M33H (Max. 8 branch), KHRP26M22H (Max. 4 branch), KHRP26M33H (Max. 8 branch)	KHRP25M33H (Max. 8 branch), KHRP25M72H (Max. 8 branch), KHRP26M22H (Max. 4 branch), KHRP26M33H (Max. 8 branch), KHRP26M72H (Max. 8 branch)	KHRP25M33H (Max. 8 branch), KHRP25M72H (Max. 8 branch), KHRP26M22H (Max. 4 branch), KHRP26M33H (Max. 8 branch), KHRP26M72H (Max. 8 branch), KHRP26M73H (Max. 8 branch)
		REFNET joint	KHRP25A22T, KHRP25A33T, KHRP26A22T, KHRP26A33T	KHRP25A22T, KHRP25A33T, KHRP25A72T, KHRP26A22T, KHRP26A33T, KHRP26A72T	KHRP25A22T, KHRP25A33T, KHRP25A72T, KHRP26A22T, KHRP26A33T, KHRP26A72T
3	Outside unit multi connection piping kit	For heat pump	—	BHFP22MA56	BHFP22MA84
		For heat recovery	—	BHFP26MA56	BHFP26MA84
4	External control adaptor		DTA104A62		
5	Strainer kit		BWU26A15, BWU26A20 (Applies to RWEYQ-PY1 only)		

Note: *1 In the case of heat recovery system, cool/heat selector cannot be connected.

*2 Strainer kit is equipped as a standard accessory with 60Hz models. This option is necessary for replacement use for 60Hz models.

Strainer kit specifications (50 Hz only)

Model	BWU26A15		BWU26A20	
Pressure resistance	MPa	1.47		1.96
Mesh size		50		50
Connection diameter		PT1 1/4B internal thread		PT1 1/4B internal thread

Note: Strainer kit is equipped as a standard accessory with 60 Hz models.

BS UNITS FOR HEAT RECOVERY

Centralised BS Unit (50 Hz only)

No.	Item	Type	BSV4Q100P	BSV6Q100P
1	Cool/heat selector		KRC19-26A	
2	Closed pipe kit		KHFP26A100C	

Individual Control Systems

Navigation remote controller (Wired remote controller) (Option)



BRC1E61

- Large buttons and arrow keys for easy operation.
- Guide on display gives an explanation of each setting.
- Backlight and dot matrix LCD display for easy viewing.
- Weekly schedule timer can be set up easily.
- 10 display languages are available. (English, German, French, Spanish, Italian, Portuguese, Greek, Dutch, Russian and Turkish)

Wired remote controller (Option)

Displays current airflow, swing, temperature, operating mode and timer settings.



BRC1C62

Wired remote controller with weekly schedule timer (Option)

Adds weekly schedule timer function.



BRC1D61

Notes: 1. Standard remote controllers (BRC1C62) not required.
2. If the BRC1D61 is connected to the centralised remote controllers (DCS302CA61, DCS301BA61, DST301BA61), the schedule function is not available.

The wired remote controller supports a wide range of control functions

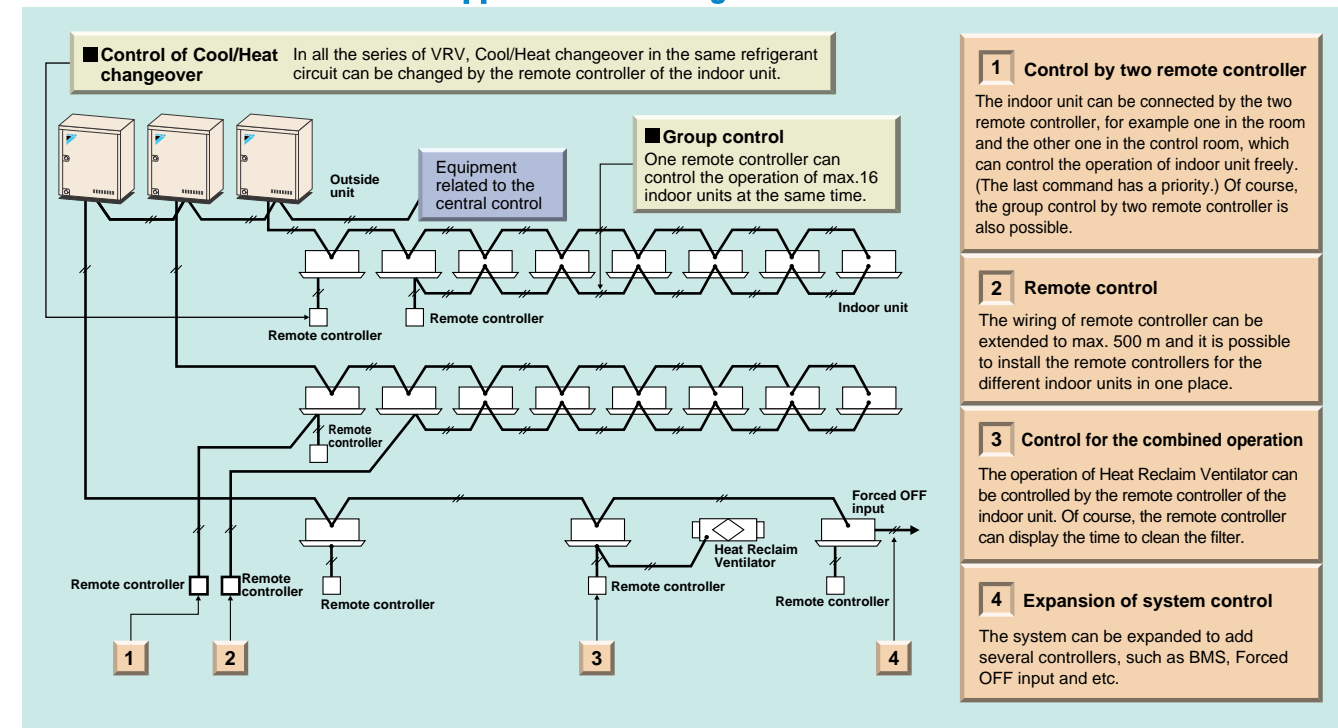

Wireless remote controller (Option)



Wireless remote controller

Signal receiver unit (Separate type)

- The same operation modes and settings as with wired remote controllers are possible.
- A compact signal receiver unit (separate type) to be mounted into a wall or ceiling is included.
 - A signal receiver unit (installed type) for a Ceiling Mounted Cassette (Round Flow, Compact Multi Flow, Double Flow) type, Ceiling Suspended type and Wall Mounted type is mounted into the indoor unit.



Signal receiver unit can be installed on the panel
ex. Ceiling Mounted Cassette (Round Flow) type

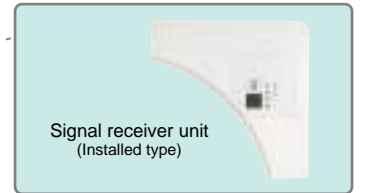

Signal receiver unit (Installed type)

*Wireless remote controller and signal receiver unit are sold as a set.
*Refer to page 39 for the name of each model.

Simplified remote controller (Option)



Exposed type (BRC2C51)

Concealed type (For hotel use) (BRC3A61)

- The remote controller has centralised its frequently used operation selectors and switches (on/off, operation mode, temperature setting and airflow volume), making itself suitable for use in hotel rooms or conference rooms.
- The exposed type remote controller is fitted with a thermostat sensor.



The concealed type remote controller smartly fits into a night table or console panel in a hotel room.

Wide variation of remote controllers for indoor units

	FXFQ	FXZQ	FXCQ	FXKQ	FXDQ	FXMQ	FXHQ	FXAQ	FXL(N)Q	FXUQ
Navigation remote controller (Wired remote controller) (BRC1E61)	●	●	●	●	●	●	●	●	●	●
Wired remote controller (BRC1C62)	●	●	●	●	●	●	●	●	●	●
Wired remote controller with weekly schedule timer (BRC1D61)	●	●	●	●	●	●	●	●	●	●
Wireless remote controller* (Installed type signal receiver unit)	●	●	●				●	●		●
Wireless remote controller* (Separate type signal receiver unit)				●	●	●			●	
Simplified remote controller (Exposed type) (BRC2C51)					●	●			●	
Simplified remote controller (Concealed type: for Hotel use) (BRC3A61)					●	●			●	

*Refer to page 39 for the name of each model.

Control systems

Centralised Control Systems

- Up to 64 groups of indoor units (128 units) can be centrally controlled.
- Optional controllers for centralised control can be combined freely, and system can be designed in accordance with building scale and purpose.
- System integration with various air-conditioning peripheral equipment such as Heat Reclaim Ventilator is easy.
- Wiring can be run up to a total length of 2 km, and adapts easily to large-scale system expansion.

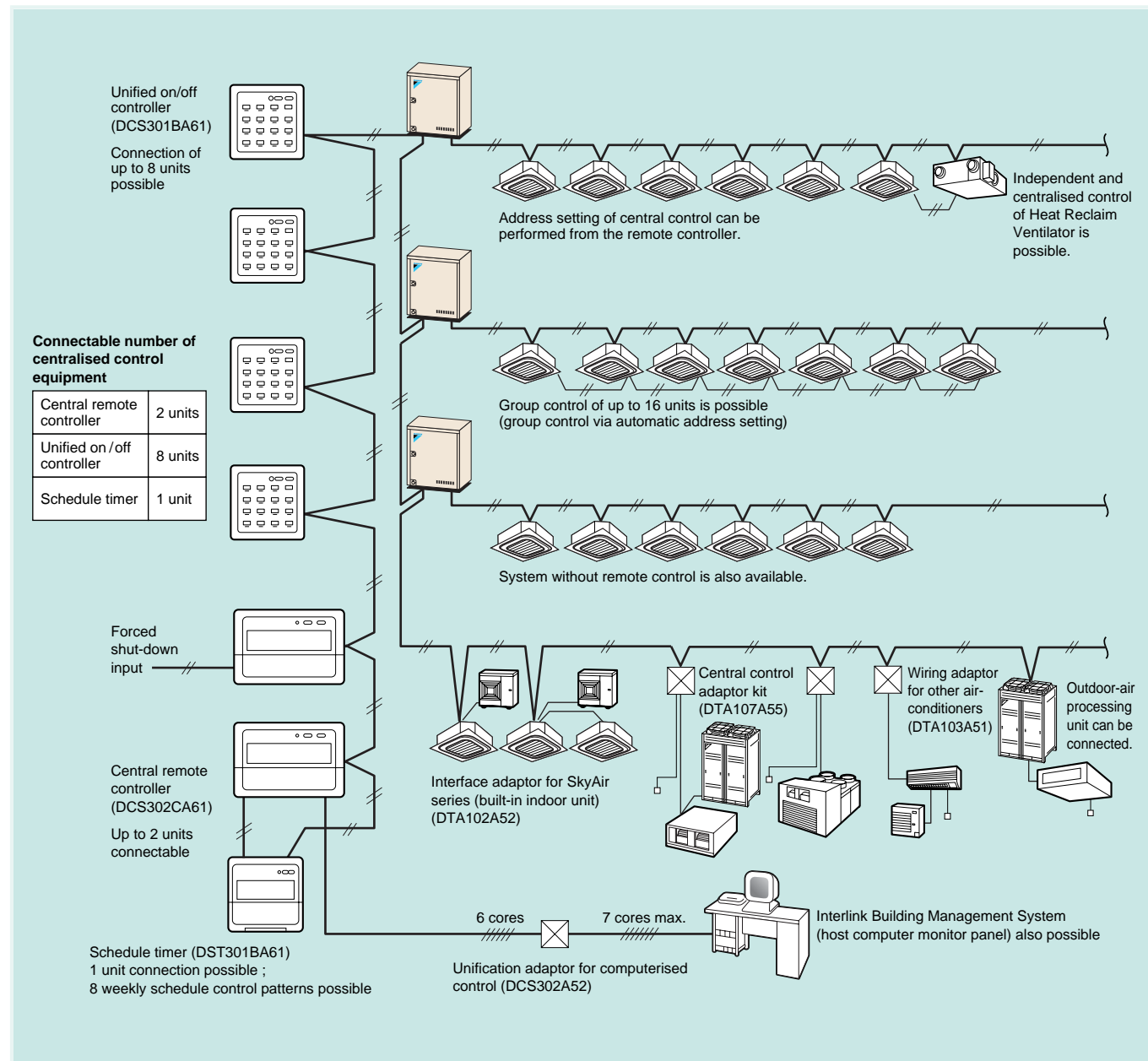

*Certain indoor units limit the functions of some control systems.
For more details, please refer to the Engineering Data Book.

Central remote controller (Option)



DCS302CA61

Max. 64 groups (zones) of indoor units can be controlled individually same as LCD Remote controller.

- Max. 64 groups (128 indoor units) controllable
- Max. 128 groups (128 indoor units) are controllable by using 2 central remote controllers, which can control from 2 different places.
- Zone control
- Malfunction code display
- Max. wiring length 1,000 m (Total: 2,000 m)
- Connectable with Unified ON/OFF controller, schedule timer and BMS system
- Airflow volume and direction can be controlled individually for indoor units in each group operation.
- Ventilation volume and mode can be controlled for Heat Reclaim Ventilator.
- Up to 4 ON/OFF pairs can be set per day by connecting a schedule timer.

Unified ON/OFF controller (Option)



DCS301BA61

Max. 16 groups of indoor units can be operated simultaneously/individually.

- Max. 16 groups (128 indoor units) controllable
- 2 remote controllers can be used to control from 2 different places.
- Operating status indication (Normal operation, Alarm)
- Centralised control indication
- Max. wiring length 1,000 m (Total: 2,000 m)
- Compact size casing (Thickness: 16 mm)
- Connectable with Central Remote controller, Schedule timer and BMS system

Schedule timer (Option)



DST301BA61

Max. 128 indoor units can be operated as programmed schedule.

- Max. 128 indoor units controllable
- When used in combination with a central remote controller, a maximum of 8 weekly schedule patterns can be set, while the central controller can be used to select desired zones. Up to 2 ON/OFF pairs can be set per day.
- Max. 48 hours back up power supply
- Max. wiring length 1,000 m (Total: 2,000 m)
- Compact size casing (Thickness: 16 mm)
- Connectable with Central Remote controller, Unified ON/OFF controller and BMS system

Interface adaptors (Option)

Part name	Model No.	Function
Unification adaptor for computerised control	★ DCS302A52	Interface between the central monitoring board and central control units. Combined with the central remote controller, this adaptor enables the central monitoring board to centralise such functions as the on/off control, operation status monitoring, and normal/malfunction monitoring. ^(*)
Interface adaptor for SkyAir series	★ DTA102A52 <small>For SkyAir, FD(Y)M-FA, FDYB-KA, FDY-KA, FVY(P)J-A, FXUQ-MA</small>	Adaptors required to connect products other than those of the VRV System to the high-speed DIII-NET communication system adopted for the VRV System.
Central control adaptor kit	★ DTA107A55 <small>For UAT(Y)-K(A), FD-K</small>	
Wiring adaptor for other air-conditioner	★ DTA103A51 <small>For air conditioners other than mentioned above.</small>	

Note: Installation box for ★ adaptor must be obtained locally.

Control systems

Advanced control systems

Intelligent Controller

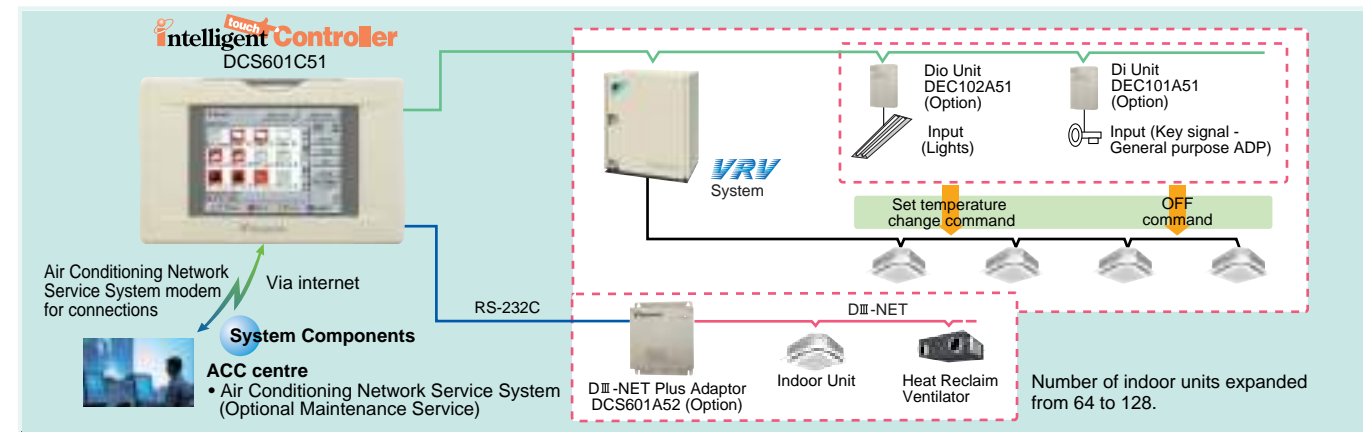

Communication functions in the user-friendly icon-based multilingual controller simplify centralised control of the VRV system.

Features

- Colour LCD touch panel icon display
- Multi language (English, French, Italian, German, Spanish, Dutch, Portuguese, Chinese and Korean)
- Yearly schedule
- Enhanced history function
- Built-in modem for connecting to Air Conditioning Network Service System (Option)
- Doubling of number of connectable indoor units by adding a DIII-NET Plus Adaptor (Option)
- Management of facilities/equipment other than A/C units (By adding Dio unit or Di unit)
- Small manageable size
- Simplified engineering
- Auto heat/cool change-over
- Simple Interlock Function
- Temperature limitation

Intelligent Manager

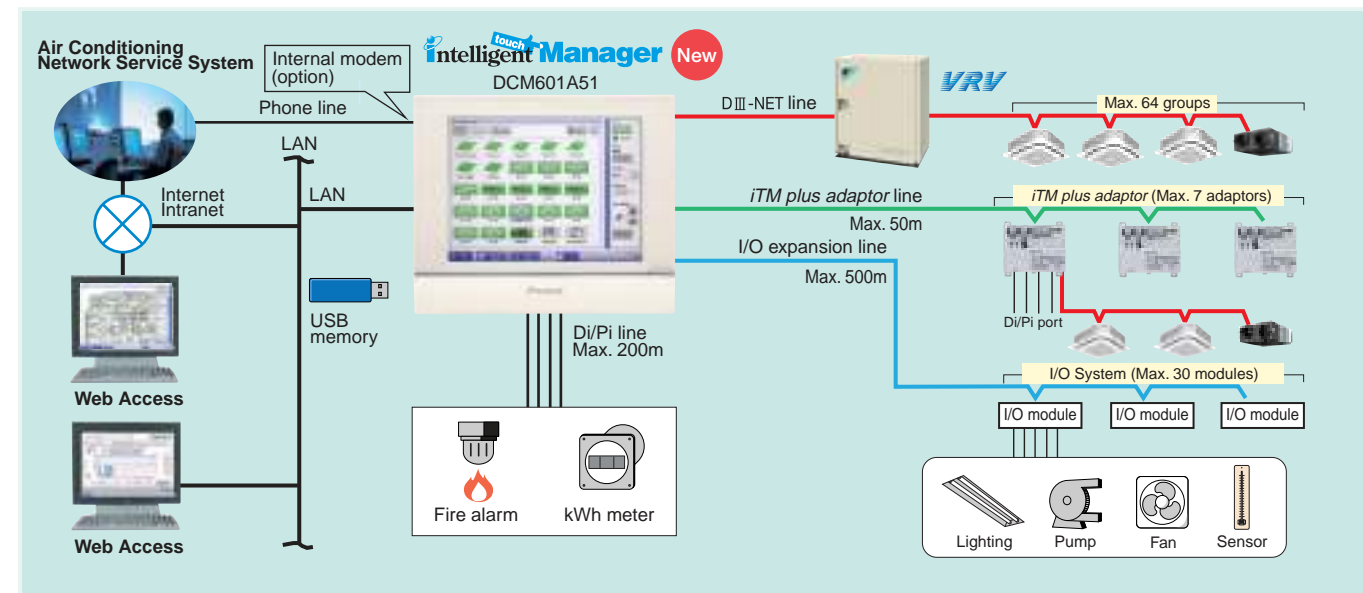

One touch selection to total air comfort

Daikin proudly introduces its new *Intelligent Touch Manager*, a VRV system controller featuring an array of simple, useful system management functions for added value. Up to 2,560 groups (5,120 indoor units) can be controlled by one system

Features

- **Central control**
 - Handy area settings simplify detailed management of VRV.
 - Display of floor plans enables a quick search of desired air conditioning units.
 - Operation history shows manner of control and origin in past operations of air conditioning units.
- **Remote access**
 - Remote access with a PC allows total air conditioning management using the same type of screens as those displayed in the *Intelligent Touch Manager*.
 - Authorised users can centrally control individual air conditioning units from their own computers.
- **Automatic control**
 - VRVs are controlled automatically throughout the year by the schedule function.
 - Interlocking VRVs and other equipment enables easy automation of building facilities operation.
 - Setback adjusts temperature settings even when rooms are unoccupied.
- **Energy management**
 - The Energy Navigator feature simplifies energy management by tracking energy consumption data and identifying inefficient operation.
- **Troubleshooting**
 - Contact information of maintenance contractors can be registered and displayed.
 - E-mails are sent automatically to alert of malfunctions and potential trouble.
 - The *Intelligent Touch Manager* can link to the Air Conditioning Network Service System for 24-hour monitoring of operating conditions and status.
- **Scalability**
 - A single *Intelligent Touch Manager* can manage a small building or be expanded to handle medium- to large-sized buildings.
 - Large building properties can also take advantage of the *iTM integrator* to link up and expand system up to 5 *Intelligent Touch Managers* for integrated control.

Interface for BACnet® and LONWORKS®

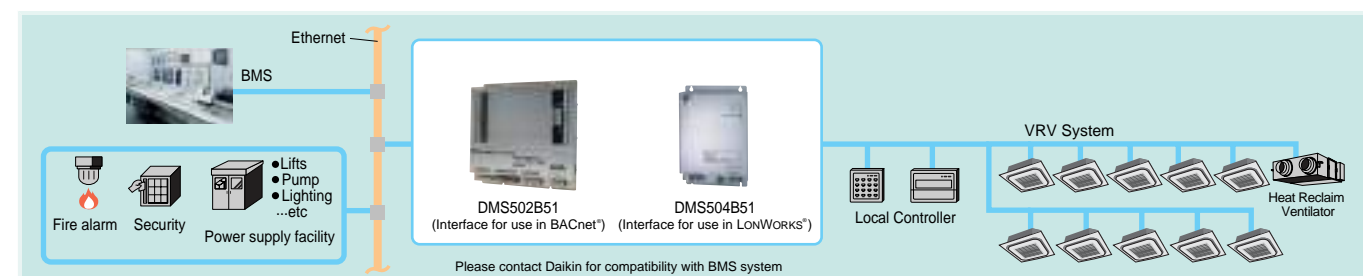

Air Conditioning Network Service System

Maintenance services that boost profits and customer satisfaction

- 24 hour on-line diagnostic system
- Energy saving and extension of aircon operating life
- Maintenance management via A/C network service system reports
- Reliable service at short lead time

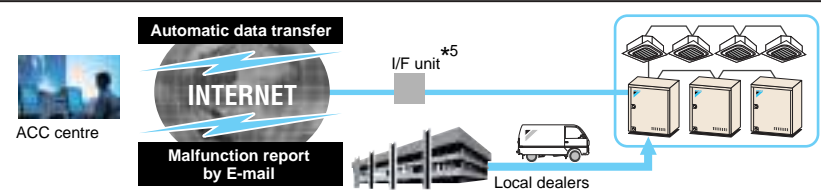

Integrated control systems that recognise the trend of open control systems

- Compatibility with BMS enhanced by utilising the international communication standards, BACnet® or LONWORKS®.

DMS502B51 Interface for use in BACnet®

- BTL Certification
- PPD data (Optional Di board is required.)
- ISO 16484-5 (Does not support IEEE 802.3 protocol for BACnet®)
- Conformance class 3 (ASHRAE 135-1995)
- Standard BACnet® Device B-ASC (ASHRAE 135-2001)
- Up to 40 outside units and 256 indoor unit groups on one gateway (Optional adaptor)

DMS504B51 Interface for use in LONWORKS®

- XIF file for confirming of specifications of the units.
- Connectable up to 10 outside units and 64 indoor unit groups.

*1. There are restrictions in applicable areas and release times, therefore please consult us separately for details.
 *2. Model name varies upon the system size.
 *3. BACnet® is a registered trademark of American Society of Heating, Refrigerating and Air-Conditioning Engineers (ASHRAE).
 *4. LonWorks® is a trademark of Echelon Corporation registered in the United States and other countries.
 *5. For an I/F unit, one of the following can be selected: **Local Controller**, **Intelligent Touch Controller**, or **Intelligent Touch Manager**.
 *6. Refer to the Options page for the name of each model.

OPTIONS

Operation Control System Optional Accessories

No.	Item	Type	Type											
			FXFQ-P	FXZQ-M	FXCQ-M	FXKQ-MA	FXDQ-PB FXDQ-NB	FXMQ-P	FXMQ-MA	FXHQ-MA	FXAQ-P	FXLQ-MA FXNQ-MA	FXUQ-MA	BSV(4,6)Q-P
1	Remote controller	Wireless	BRC7F634F	BRC7E530W	BRC7C62	BRC4C61	BRC4C65	BRC4C65	BRC4C62	BRC7EA63W	BRC7EA618	BRC4C62	BRC7CA528W	—
		Wired	BRC1C62											
2	Navigation remote controller (Wired remote controller)		BRC1E61											
3	Wired remote controller with weekly schedule timer		BRC1D61											
4	Simplified remote controller (Exposed type)		—				BRC2C51		—		BRC2C51		—	
5	Remote controller for hotel use (Concealed type)		—				BRC3A61		—		BRC3A61		—	
6	Adaptor for wiring		*KRP1C63	*KRP1BA57	*KRP1B61	KRP1B61	*KRP1B56	*KRP1C64	KRP1B61	KRP1BA54	—	KRP1B61	—	—
7-1	Wiring adaptor for electrical appendices (1)		*KRP2A62	*KRP2A62	*KRP2A61	KRP2A61	*KRP2A53	*KRP2A61	KRP2A61	*KRP2A62	*KRP2A61	KRP2A61	—	—
7-2	Wiring adaptor for electrical appendices (2)		*KRP4AA53	*KRP4AA53	*KRP4AA51	KRP4AA51	*KRP4A54	*KRP4AA51	KRP4AA51	*KRP4AA52	*KRP4AA51	KRP4AA51	*KRP4AA53	—
8	Remote sensor (for indoor temperature)		KRCS01-4B	KRCS01-1B			KRCS01-4B	KRCS01-1B				—		
9	Installation box for adaptor PCB ☆		Notes 2, 3 KRP1H98	Notes 4, 6 KRP1BA101	Notes 2, 3 KRP1B96	—	Notes 4, 6 KRP1BA101	Notes 2, 3 KRP4A96	—	Notes 3 KRP1CA93	Notes 2, 3 KRP4A93	—	KRP1BA97	—
10	External control adaptor for outdoor unit		*DTA104A62	*DTA104A62	*DTA104A61	DTA104A61	*DTA104A53	*DTA104A61	DTA104A61	*DTA104A62	*DTA104A61	DTA104A61	—	—
11	Adaptor for multi tenant		*DTA114A61	—				*DTA114A61	—		*DTA114A61	—		DTA114A61

Note: 1. Installation box ☆ is necessary for each adaptor marked ★.
 2. Up to 2 adaptors can be fixed for each installation box.
 3. Only one installation box can be installed for each indoor unit.
 4. Up to 2 installation boxes can be installed for each indoor unit.
 5. Installation box ☆ is necessary for second adaptor.
 6. Installation box ☆ is necessary for each adaptor.

System Configuration

No.	Item	Model No.	Function
1	Central remote controller	Note 2 DCS302CA61	•Up to 64 groups of indoor units(128 units) can be connected, and ON/OFF, temperature setting and monitoring can be accomplished individually or simultaneously. Connectable up to 2 controllers in one system.
1-1	Electrical box with earth terminal (3 blocks)	KJB311AA	
2	Unified ON/OFF controller	Note 2 DCS301BA61	
2-1	Electrical box with earth terminal (2 blocks)	KJB212AA	•Up to 16 groups of indoor units(128 units) can be turned, ON/OFF individually or simultaneously, and operation and malfunction can be displayed. Can be used in combination with up to 8 controllers.
2-2	Noise filter (for electromagnetic interface use only)	KEK26-1A	
3	Schedule timer	Note 2 DST301BA61	•Programmed time weekly schedule can be controlled by unified control for up to 64 groups of indoor units (128 units). Can turn units ON/OFF twice per day.
4	Interface adaptor for SkyAir-series	For SkyAir, FD(Y)M-FA, FDY-KA, FDYB-KA, FVY(P)J-A, FXUQ-MA ★ DTA102A52	
5	Central control adaptor kit	For UAT(Y)-K(A),FD-K ★ DTA107A55	•Adaptors required to connect products other than those of the VRV System to the high-speed DIII-NET communication system adopted for the VRV System. * To use any of the above optional controllers, an appropriate adaptor must be installed on the product unit to be controlled.
6	Wiring adaptor for other air-conditioner	★ DTA103A51	
7	DIII -NET Expander Adaptor	DTA109A51	•Up to 1024 units can be centrally controlled in 64 different groups. •Wiring restrictions (max. length : 1,000 m, total wiring length : 2,000 m max. number of branches : 16) apply to each adaptor.
7-1	Mounting plate	KRP4A92	•Fixing plate for DTA109A51

Notes: 1. Installation box for ★ adaptor must be obtained locally.
 2. For FXUQ-MAV1, an interface adaptor (DTA102A52) for the SkyAir series is necessary.

OPTIONS

Building Management System

No.	Item	Model No.	Function
1	intelligent Touch Controller	Basic	intelligent Touch Controller
1-1		Option	DIII-NET plus adaptor
1-2	Electrical box with earth terminal (4 blocks)		KJB411A
2	intelligent Touch Manager	Basic	Hardware
2-1		Option	Hardware
2-2			Software
2-3		Software	
2-4			
2-5	Di unit	DEC101A51	•8 pairs based on a pair of On/Off input and abnormality input.
2-6	Dio unit	DEC102A51	•4 pairs based on a pair of On/Off input and abnormality input.
3	Communication line	*1 Interface for use in BACnet®	
3-1		Optional DIII board	
3-2		Optional Di board	
4		*2 Interface for use in LonWorks®	
5	Contact/ analogue signal	Unification adaptor for computerised control	★DCS302A52

Notes: *1. BACnet® is a registered trademark of American Society of Heating, Refrigerating and Air-Conditioning Engineers (ASHRAE).
 *2. LonWorks® is a trademark of Echelon Corporation registered in the United States and other countries.
 *3. Installation box for ★ adaptor must be obtained locally.

Heat Reclaim Ventilator

with DX-Coil and Humidifier — VKM series 50 Hz only

The Heat Reclaim Ventilator lineup features the DX-coil in response to recently diversifying outdoor air introduction requirements.

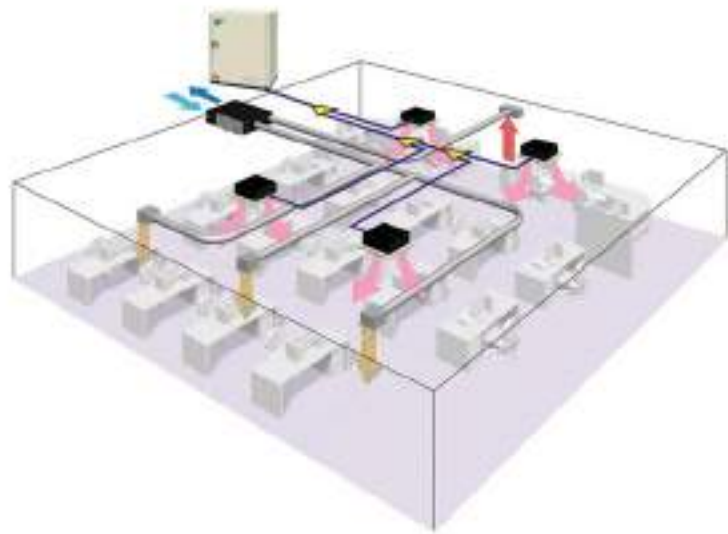

Line up

With DX Coil & Humidifier Type			
Model Name	VKM50GAMV1	VKM80GAMV1	VKM100GAMV1
Capacity Index	31.25	40	50

With DX Coil Type			
Model Name	VKM50GAV1	VKM80GAV1	VKM100GAV1
Capacity Index	31.25	40	50



Humidifier

The lineup includes models with a humidifier, in response to diversifying customer requirements. (VKM50/80/100GAMV1 only)

DX-coil

The Heat Reclaim Ventilator features DX-coil that contributes to the prevention of cold airflow hitting people directly during heating operation, due to the after-cool, after-heat operations done beforehand.

High static pressure

High external static pressure means enhanced design flexibility.

Efficient outdoor air introduction is possible

Heat Reclaim Ventilator (VKM series) series introduces fresh outdoor air with minimum heat losses, while a wide variety of features respond to customer requirements.

Air conditioning and outdoor air processing can be accomplished using a single system.

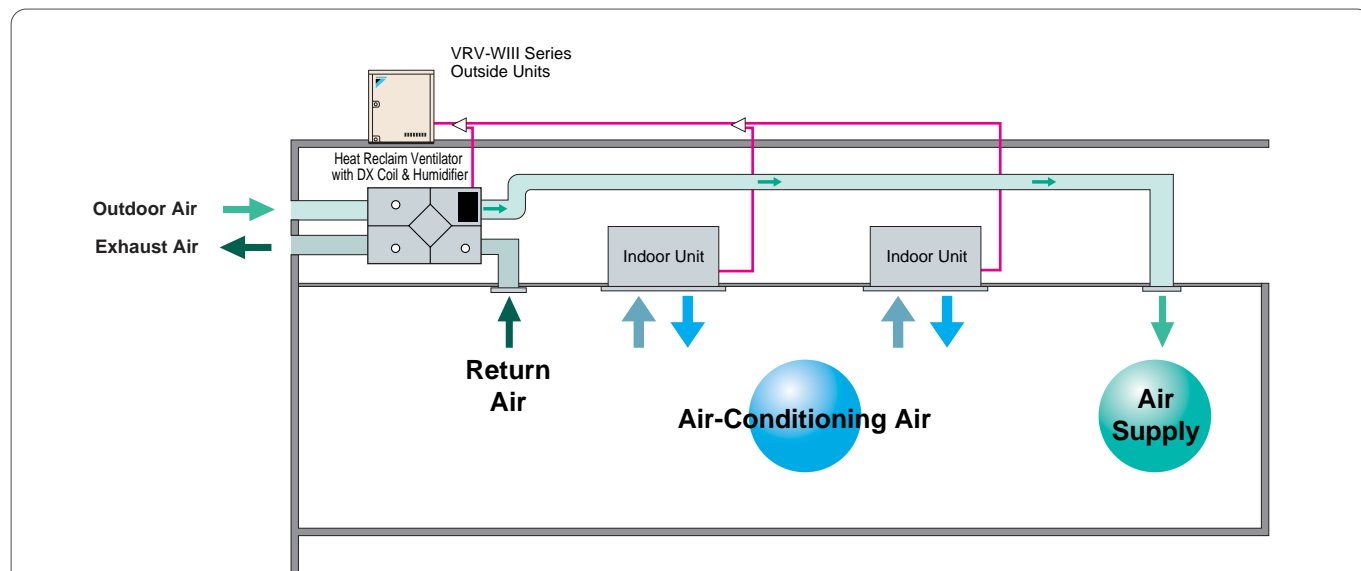

Connection Conditions

The following restrictions must be observed in order to maintain the indoor units connected to the same system.

- When Heat Reclaim Ventilator VKM series units are connected, the total connection capacity index must be 50% to 130% of the capacity index of the outside units.

A compact unit packed with Daikin's cutting-edge technologies



HEP Element (Anti-mould)

Operation of the heat exchanger element

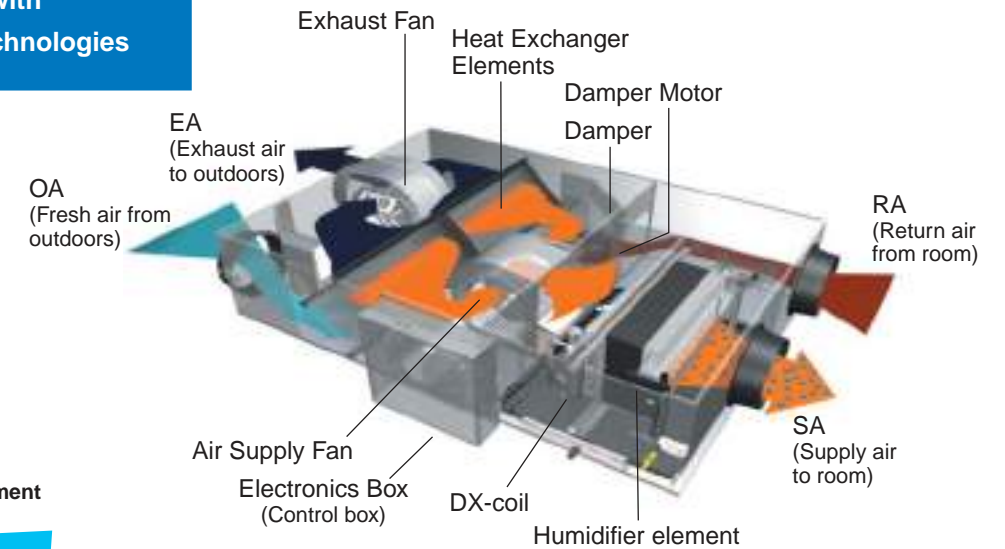
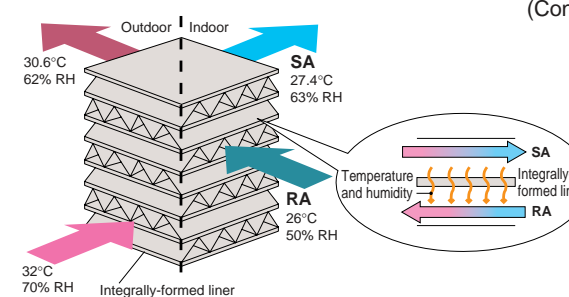

DX-coil (Direct expansion coil)



Humidifier element

Heating and humidification process

Structure of VKM series

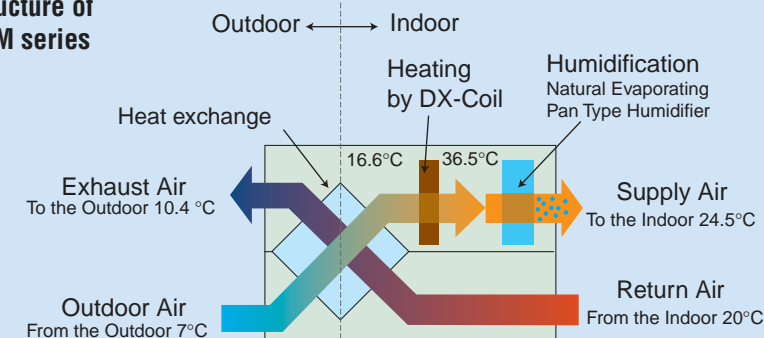

Humidification: 5.4kg/h

(VKM100GAMV1)
The Outdoor air is heated from 16.6 °C to 36.5 °C with DX-coil, Natural Evaporating Pan Type Humidifier is passed and humidification capacity is improved.

DX-Coil: Heat Exchanger which heating or cooling the air by VRV-WIII outside unit's refrigerant.

Efficient outdoor air introduction with heat exchanger and cooling/heating operation

Indoor unit with outdoor air treatment

Using outdoor air, the temperature can be brought near room temperature with minimal cooling capacity through the use of outdoor air.

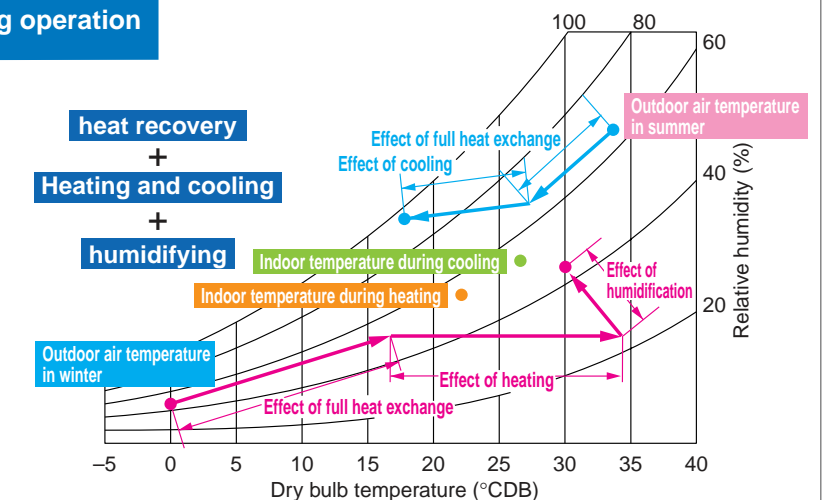

Other features

- Integrated system includes ventilation and humidifying operations.
- Ventilation, cooling/heating and humidifying are possible with one remote controller.

SPECIFICATIONS

MODEL			VKM50GAMV1*	VKM80GAMV1*	VKM100GAMV1*	VKM50GAV1	VKM80GAV1	VKM100GAV1	
Refrigerant			R-410A						
Power Supply			1-phase, 220-240 V, 50 Hz						
Airflow Rate & Static Pressure (Note 7)	Ultra-high	Airflow rate	m ³ /h	500	750	950	500	750	950
		Static pressure	Pa	160	140	110	180	170	150
	High	Airflow rate	m ³ /h	500	750	950	500	750	950
		Static pressure	Pa	120	90	70	150	120	100
	Low	Airflow rate	m ³ /h	440	640	820	440	640	820
		Static pressure	Pa	100	70	60	110	80	70
Power Consumption	Heat exchange mode	Ultra-high	W	560	620	670	560	620	670
		High	W	490	560	570	490	560	570
		Low	W	420	470	480	420	470	480
	Bypass mode	Ultra-high	W	560	620	670	560	620	670
		High	W	490	560	570	490	560	570
		Low	W	420	470	480	420	470	480
Fan Type			Sirocco Fan						
Motor Output			kW						
Sound Level (Note 5) (220/230/240 V)	Heat exchange mode	Ultra-high	dB(A)	37/37.5/38	38.5/39/40	39/39.5/40	38/38.5/39	40/41/41.5	40/40.5/41
		High	dB(A)	35/35.5/36	36/37/37.5	37/37.5/38	36/36.5/37	37.5/38/39	38/38.5/39
		Low	dB(A)	32/33/34	33/34/35.5	34/34.5/35.5	33.5/34.5/35.5	34.5/36/37	35/36/36.5
	Bypass mode	Ultra-high	dB(A)	37/37.5/38	38.5/39/40	39/39.5/40	38/38.5/39	40/41/41.5	40/40.5/41
		High	dB(A)	35/35.5/36	36/37/37.5	37/37.5/38	36/36.5/37	37.5/38/39	38/38.5/39
		Low	dB(A)	32/33/34	33/34/35.5	34/34.5/35.5	33.5/34.5/35.5	34.5/36/37	35/36/36.5
Humidification Capacity (Note 4)			kg/h						
Temp. Exchange Efficiency	Ultra-high	%	76	78	74	76	78	74	
	High	%	76	78	74	76	78	74	
	Low	%	77.5	79	76.5	77.5	79	76.5	
Enthalpy Exchange Efficiency (Cooling)	Ultra-high	%	64	66	62	64	66	62	
	High	%	64	66	62	64	66	62	
	Low	%	67	68	66	67	68	66	
Enthalpy Exchange Efficiency (Heating)	Ultra-high	%	67	71	65	67	71	65	
	High	%	67	71	65	67	71	65	
	Low	%	69	73	69	73	73	69	
Casing			Galvanised Steel Plate						
Insulating Material			Self-Extinguishable Urethane Foam						
Heat Exchanging System			Air to Air Cross Flow Total Heat (Sensible + Latent Heat) Exchange						
Heat Exchanger Element			Specially Processed Nonflammable Paper						
Air Filter			Multidirectional Fibrous Fleeces						
DX-coil Capacity	Cooling (Note 2)	kW	2.8	4.5	5.6	2.8	4.5	5.6	
	Heating (Note 3)	kW	3.2	5.0	6.4	3.2	5.0	6.4	
Dimensions	Height	mm	387	387	387	387	387	387	
	Width	mm	1,764	1,764	1,764	1,764	1,764	1,764	
	Depth	mm	832	1,214	1,214	832	1,214	1,214	
Connection Duct Diameter			mm						
Machine Weight	Net	kg	102	120	125	96	109	114	
	Gross (Note 8)	kg	107	129	134	—	—	—	
Unit Ambient Condition			°C–40°C DB, 80%RH or less						
OA (Note 9)			-15°C–40°C DB, 80%RH or less						
RA (Note 9)			0°C–40°C DB, 80%RH or less						

- Notes: 1. Cooling and heating capacities are based on the following conditions. Fan is based on High and Ultra-high. When calculating the capacity as indoor units, use the following figures: VKM50GAMV1/GV1: 3.5 kW, VKM80GAMV1/GV1: 5.6 kW, VKM100GAMV1/GV1: 7.0 kW
2. Indoor temperature: 27°C DB, 19°C WB, Outdoor temperature: 35°C DB
3. Indoor temperature: 20°C DB, Outdoor temperature: 7°C DB, 6°C WB
4. Humidifying capacity is based on the following conditions: Indoor temperature: 20°C DB, 15°C WB, Outdoor temperature: 7°C DB, 6°C WB
5. The operating sound measured at the point 1.5 m below the centre of the unit is converted to that measured in an anechoic chamber built in accordance with the JIS C 1502 conditions. The actual operating sound varies depending on the surrounding conditions (near running unit's sound, reflected sound and so on) and is normally higher than this value. For operation in a quiet room, it is required to take measures to lower the sound. For details, refer to the Engineering Data.
6. The noise level at the air discharge port is about 8–11 dB(A) or higher than the unit's operating sound. For operation in a quiet room, it is required to take measures to lower the sound.
7. Airflow rate can be changed over to Low mode or High mode.
8. In case of holding full water in humidifier.
9. OA: fresh air from outdoor. RA: return air from room.
10. Specifications, design and information here are subject to change without notice.
11. Power consumption and efficiency depend on the above value of airflow rate.
12. Temperature exchange efficiency is the mean value for Cooling and Heating. Efficiency is measured under the following condition: Ratio of rated external static pressure outdoor to indoor is kept constant at 7 to 1.

13. In heating operation, freezing of the outside unit's coil increases. Heating capability decreases and the system goes into defrost operation. During defrost operation, the fans of the unit continues driving (factory setting). The purpose of this is to maintain the amount of ventilation and humidifying.
14. When connecting with a VRV-WIII system heat recovery outside unit and bringing the RA (exhaust gas intake) of this unit directly in from the ceiling, connect to a BS unit identical to the VRV-WIII indoor unit (master unit), and use group-linked operation. (See the Engineering Data for details.)
15. When connecting the indoor unit directly to the duct, always use the same system on the indoor unit as with the outdoor unit, perform group-linked operation, and make the direct duct connection settings from the remote controller. (Mode No. "17 (27)" – First code No. "5" – Second code No. "6".) Also, do not connect to the outlet side of the indoor unit. Depending on the fan strength and static pressure, the unit might back up.
- * Feed clean water (city water, tap water or equivalent). Dirty water may clog the valve or cause dirt deposits in the water container, resulting in poor humidifier performance. (Never use any cooling tower water and heating-purpose water.) Also, if the supply water is hard water, use a water softener because of short life.
- * Life of humidifying element is about 3 years (4,000 hours) under the supply water conditions of hardness: 150 mg/l. (Life of humidifying element is about 1 year (1,500 hours) under the supply water conditions of hardness: 400 mg/l.) Annual operating hours: 10 hours/day x 26 days/month x 5 months = 1,300 hours

DIMENSIONS

VKM50/80/100GA(M)V1

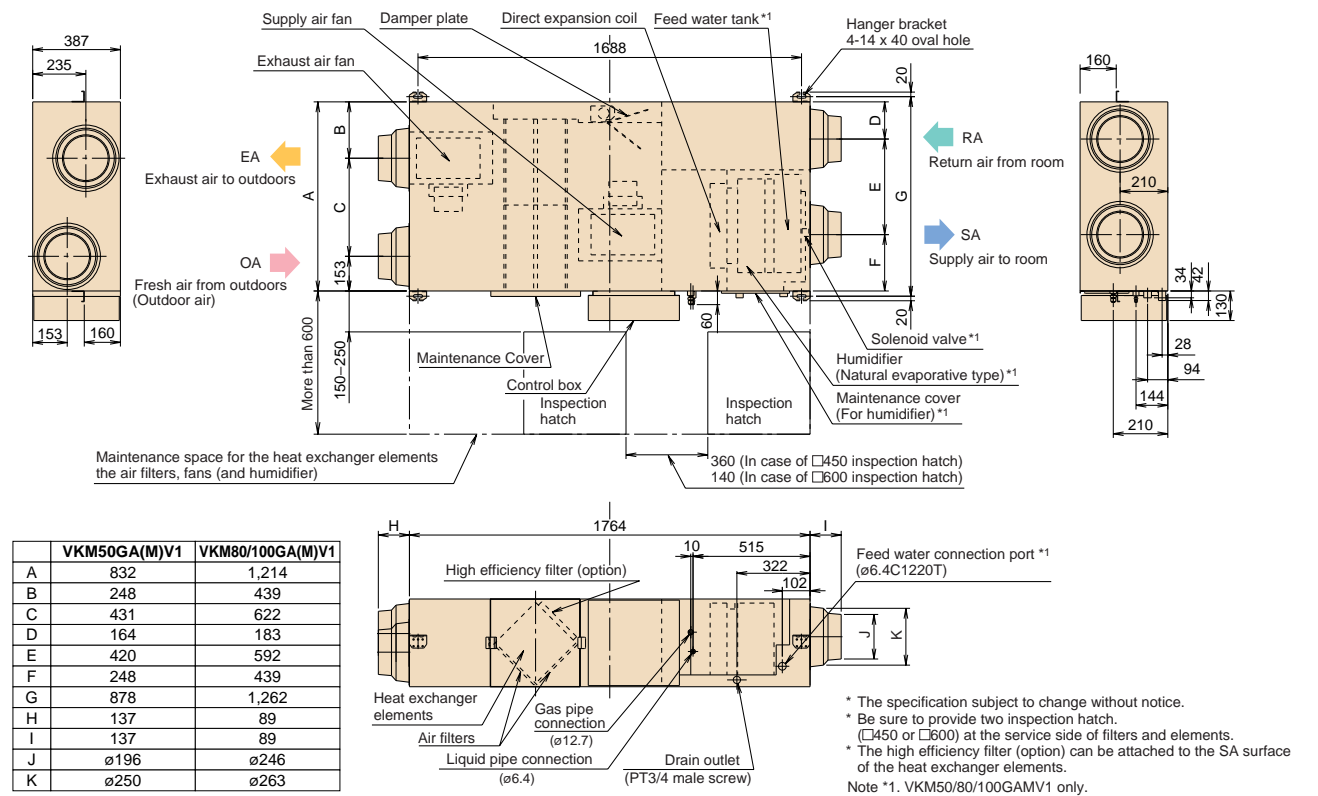

OPTIONS

Item	Type	VKM50/80/100GA(M)V1										
Remote controller		BRC1E61/BRC1C62/BRC1D61 *1										
Centralised controlling device	Central remote controller	DCS302CA61										
	Unified ON/OFF controller	DCS301BA61										
	Schedule timer	DST301BA61										
Wiring adaptor for electrical appendices		KRP2A61										
	For humidifier running ON signal output	KRP50-2										
	For heater control kit	BRP4A50										
	For wiring	Type (indoor unit of VRV)	FXFQ-P	FXZQ-M	FXCQ-M	FXKQ-MA	FXDQ-PB	FXMQ-P	FXMQ-MA	FXHQ-MA	FXAQ-P	FXLQ-MA
Installation box for adaptor PCB*		KRP1C63*	KRP1BA57*	KRP1B61*	KRP1B61	KRP1B56*	KRP1C64*	KRP1B61	KRP1BA54	—	KRP1B61	—
		Notes 2, 3	Note 4, 6	Notes 2, 3	—	Notes 4, 6	Notes 2, 3	—	Note 3	Notes 2, 3	—	KRP1BA97

- Notes: 1. Installation box * is necessary for each adaptor marked *.
2. Up to 2 adaptors can be fixed for each installation box.
3. Only one installation box can be installed for each indoor unit.
4. Up to 2 installation boxes can be installed for each indoor unit.
5. Installation box * is necessary for second adaptor.
6. Installation box * is necessary for each adaptor.
7. *1 Necessary when operating Heat Reclaim Ventilator (VKM) independently. When operating interlocked with other air conditioners, use the remote controllers of the air conditioners.

Item	Type	VKM50GA(M)V1	VKM80GA(M)V1	VKM100GA(M)V1
Additional function	Silencer	—	—	KDDM24B100
	Air suction/ Discharge grille	Nominal pipe diameter	mm	φ 250 mm
		White	mm	K-DGL200B
	High efficiency filter	Nominal pipe diameter	mm	φ 200
Air filter for replacement		mm	φ 250	KAF242G80M
Flexible duct (1 m)		K-FDS201D	K-FDS251D	K-FDS252D
Flexible duct (2 m)		K-FDS202D	K-FDS252D	K-FDS252D

Heat Reclaim Ventilator

The Heat Reclaim Ventilator Creates a High-Quality Environment by Interlocking with the Air Conditioner

- Improved Enthalpy Efficiency ^{*1}
- Higher External Static Pressure ^{*2}
- Enhanced Energy Saving Functions

This series provides higher enthalpy efficiency^{*1}, due to the greatly enhanced performance of the thin film element. Furthermore, improved external static pressure^{*2} offers more flexibility for installation. Along with these three outstanding improvements, the nighttime free cooling operation contributes to energy conservation and more comfortable space.

^{*1} For models: VAM150/250/350/650/800/1000/2000GJVE
^{*2} For models: VAM150/350/500GJVE

Model Names

VAM150GJVE, VAM250GJVE, VAM350GJVE, VAM500GJVE, VAM650GJVE, VAM800GJVE, VAM1000GJVE, VAM1500GJVE, VAM2000GJVE



Heat Reclaim Ventilator remote controller* BRC301B61 (Option)

* This remote controller is used in case of independent operation of Heat Reclaim Ventilator.

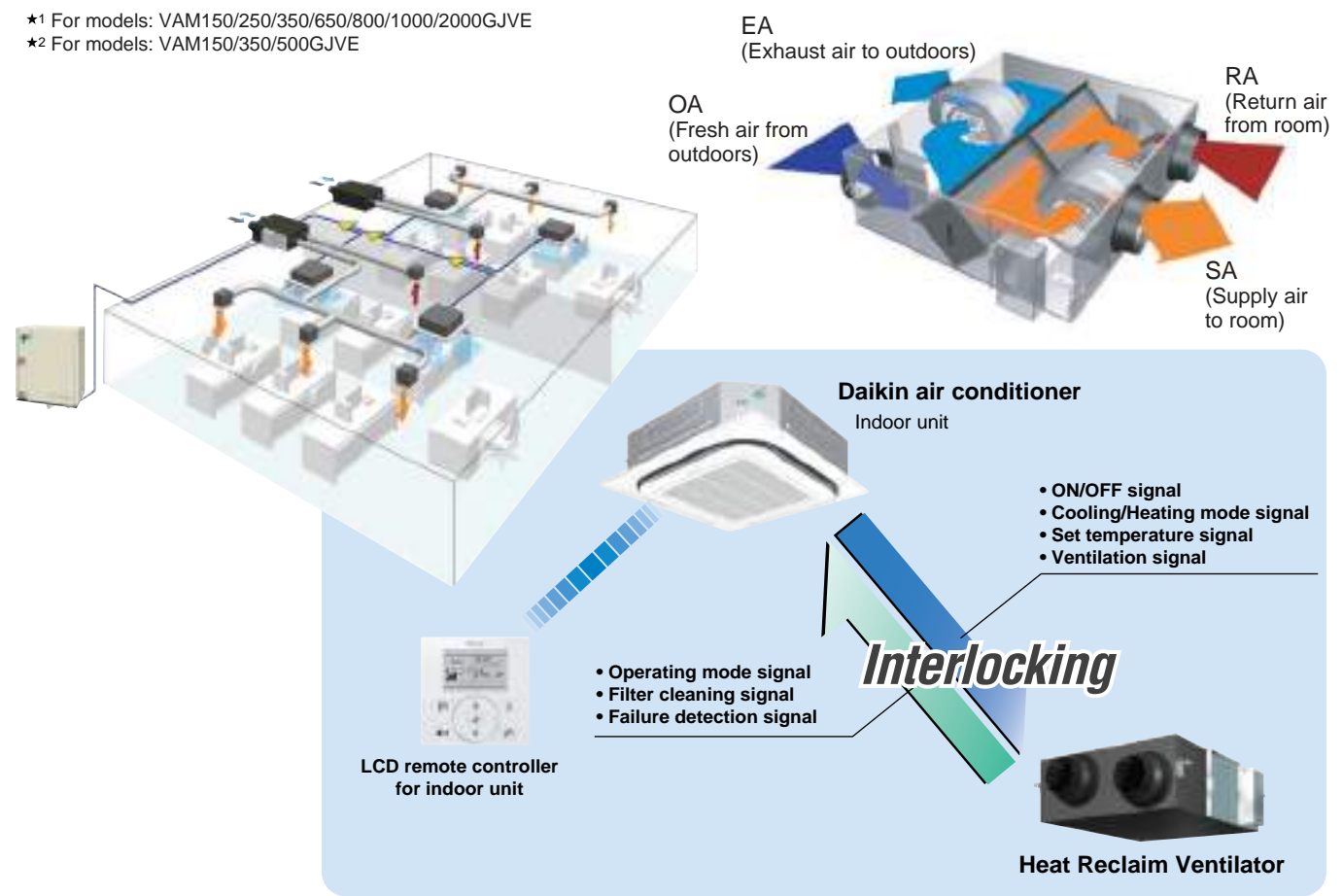

Compact Equipment

With a height of just 306 mm, the unit easily fits in limited spaces, such as above ceilings.

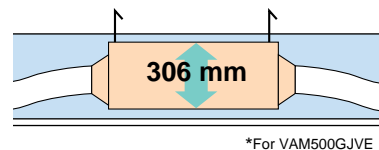

Energy Conservation

Air conditioning load reduced by approximately 31%!

Cold Climate Compatible

Standard operation at temperatures down to -15°C.

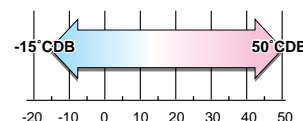

Air conditioning load reduced by approximately 31%!

Total heat exchange ventilation

This unit recovers heat energy lost through ventilation and curbs room temperature changes caused by ventilation, thereby conserving energy and reducing the load on the air conditioning system.

Enthalpy efficiency drastically improved by employing thin film element! (VAM-GJ model)

Due to the thinner film...

- Decreases the moisture resistance of the partition sheets drastically.
- Realises more space for extra layers in the element, resulting in increased effective area that supply and exhaust air can be exposed to.

Moisture absorption increased by approx. 10%!

Thickness of the partition sheet
40 μm

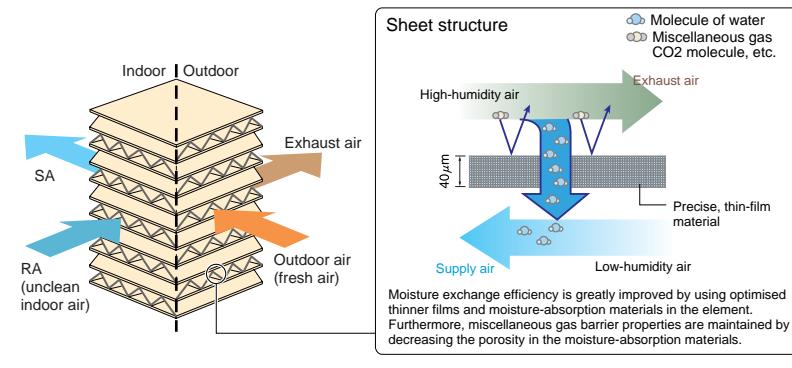

- The air conditioning load reduction values may vary according to weather and other environmental conditions at the location of the machine's installation.
- The air conditioning load reduction values are based on the following conditions; Application: Tokyo office building Building form: 2 floors above ground, 6 floors underground, floor area 2,100 m² Personnel density: 0.25 person/m² Ventilation volume: 25 m³/h Indoor air conditioning level: summer 25°C 50% RH, intermediate seasons 24°C 50% RH, winter 22°C 40% RH Operating time: 2745 hours (9 hours per day, approx. 25 days per month) Calculation method: simulation based on "MICRO-HASP/1982" of the Japan Building Mechanical and Electrical Engineers Association.

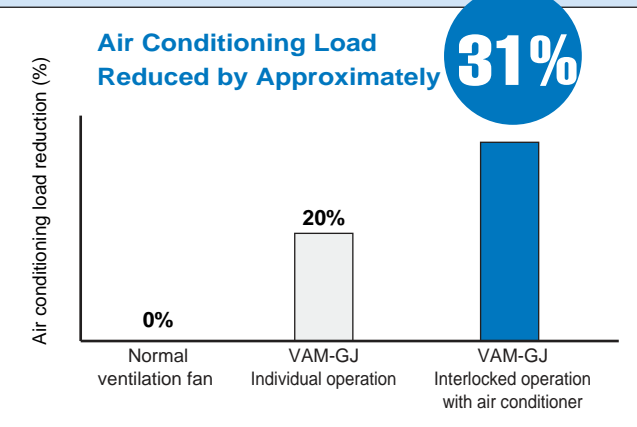

Nighttime free cooling operation^{*1}

Nighttime free cooling operation is an energy-conserving function that works at night when air conditioners are off. By ventilating rooms containing office equipment that raises the room temperature, nighttime free cooling operation reduces the cooling load when air conditioners are turned on in the morning. It also alleviates feelings of discomfort in the morning caused by heat accumulated during the night.

- Nighttime free cooling operation only works to cool and if connected to Building Multi or VRV systems.
- Nighttime free cooling operation is set to "off" in the factory settings, so if you wish to use it, request your dealer to turn it on.

^{*1} This function can be operated only when interlocked with air conditioners.
^{*2} Value is based on the following conditions:
 •Cooling operation performed from April to October.
 •Calculated for air conditioning sensible heat load only (latent heat load not included).

The indoor accumulated heat is discharged at night. This reduces the air conditioning load the next day thereby increasing efficiency.

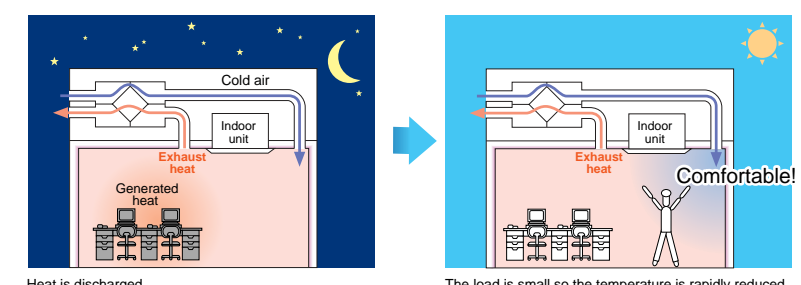

Air conditioning sensible heat load reduced by **approx. 5%^{*2}**!

*Interlocked operation with an air conditioner

SPECIFICATIONS

MODEL		VAM150GJVE	VAM250GJVE	VAM350GJVE	VAM500GJVE	VAM650GJVE	VAM800GJVE	VAM1000GJVE	VAM1500GJVE	VAM2000GJVE					
Power Supply		1-phase, 220-240 V/ 220 V, 50 Hz/ 60 Hz													
Temp. Exchange Efficiency (50 Hz/60 Hz)	Ultra-High	79/79	75/75	79/79	74/74	75/75	72/72	78/78	72/72	77/77					
	High	79/79	75/75	79/79	74/74	75/75	72/72	78/78	72/72	77/77					
	Low	84/85	79/79	82/82	80/80.5	77/77.5	74/74.5	80.5/81	75.5/76	79/81					
Enthalpy Exchange Efficiency (50 Hz/60 Hz)	For Heating	Ultra-High	72/72	71/71	70/70	67/67	67.5/67.5	65/65	70/70	65/65	72/72				
		High	72/72	71/71	70/70	67/67	67.5/67.5	65/65	70/70	65/65	72/72				
		Low	76/76.5	74/74	77/77	74/74.5	71.5/72	67.5/68	72.5/73	67/67.5	75/76				
	For Cooling	Ultra-High	66/66	63/63	66/66	55/55	61/61	61/61	64/64	61/61	62/62				
		High	66/66	63/63	66/66	55/55	61/61	61/61	64/64	61/61	62/62				
		Low	70/70.5	66/66	70/70	59/59.5	64/64.5	64/64.5	68.5/69	64/64.5	66/67				
Power Consumption (50 Hz/60 Hz)	Heat Exchange Mode	Ultra-High	125/134	137/141	200/226	248/270	342/398	599/680	635/760	1,145/1,300	1,289/1,542				
		High	111/117	120/125	182/211	225/217	300/332	517/597	567/648	991/1,144	1,151/1,315				
		Low	57/58	60/59	122/120	128/136	196/207	435/483	476/512	835/927	966/1,039				
	Bypass Mode	Ultra-High	125/134	137/141	200/226	248/270	342/398	599/680	635/760	1,145/1,300	1,289/1,542				
		High	111/117	120/125	182/211	225/217	300/332	517/597	567/648	991/1,144	1,151/1,315				
		Low	57/58	60/59	122/120	128/136	196/207	435/483	476/512	835/927	966/1,039				
Sound Level (50 Hz/60 Hz)	Heat Exchange Mode	Ultra-High	27-28.5/28.5	27-29/29	31.5-33/33	33-35.5/34	34-36/36	39-40.5/39.5	39.5-41.5/39.5	39.5-41.5/41.5	41.5-43.5/42				
		High	26-27.5/27.5	26-27.5/28	30-31.5/30	31.5-34/32	33-34.5/34	37-39.5/37.5	37.5-39.5/37.5	37.5-39.5/39.5	39-43/40				
		Low	20.5-21.5/21	21-22/21	23-25/23	25-28.5/24	27.5-29.5/28	35-37.5/34	35-37.5/34.5	35-37.5/36	36-39/39				
	Bypass Mode	Ultra-High	28.5-29.5/29.5	28.5-30.5/30.5	33-34.5/34.5	34.5-36/35.5	35-37.5/37.5	40.5-42/41	40.5-42.5/40.5	41-43/42.5	43-45.5/44				
		High	27.5-28.5/28.5	27.5-29/29.5	31.5-33/31.5	33-34.5/33.5	33-35.5/35.5	38.5-40/39	38.5-40.5/38.5	39.5-41/41.5	40.5-45/42				
		Low	22.5-23.5/22	22.5-23/22.5	24.5-26.5/24.5	25.5-28.5/25.5	27.5-30.5/29.5	36-38.5/35.5	36-38.5/35.5	36.5-38/37.5	37.5-39.5/41				
Casing		Galvanised steel plate													
Insulation Material		Self-extinguishable polyurethane foam													
Dimensions (HxWxD)	mm	278x810x551		306x879x800		338x973x832		387x1,111x832		387x1,111x1,214		785x1,619x832		785x1,619x1,214	
Machine Weigh	kg	24		32		45		55		67		129		157	
Heat Exchange System		Air to air cross flow total heat (Sensible heat+ latent heat) exchange													
Heat Exchange Element Material		Specially processed nonflammable paper													
Air Filter		Multidirectional fibrous fleeces													
Fan	Type		Sirocco fan												
	Airflow Rate (50 Hz/60 Hz)	Ultra-High	150/150	250/250	350/350	500/500	650/650	800/800	1,000/1,000	1,500/1,500	2,000/2,000				
		High	150/150	250/250	350/350	500/500	650/650	800/800	1,000/1,000	1,500/1,500	2,000/2,000				
		Low	100/95	155/155	230/230	320/295	500/470	700/670	860/840	1,320/1,260	1,720/1,580				
	External Static Pressure (50 Hz/60 Hz)	Ultra-High	120/154	70/96	169/222	105/150	85/125	133/170	168/192	112/150	116/140				
		High	106/131	54/65	141/145	66/52	53/67	92/85	110/86	73/72	58/32				
Low		56/60	24/20	67/30	32/18	35/38	72/61	85/60	56/50	45/45					
Motor Output	kW	0.030x2		0.090x2		0.140x2		0.280x2		0.280x4					
Connection Duct Diameter	mm	φ 100		φ 150		φ 200		φ 250		φ 350					
Unit Ambient Condition		-15°C~50°CDB, 80%RH or less													

- Notes: 1. Sound level is measured at 1.5 m below the centre of the body.
2. Airflow rate can be changed over to Low mode or High mode.
3. Sound level is measured in an anechoic chamber.
Sound level generally becomes greater than this value depending on the operating conditions, reflected sound, and peripheral noise.
4. The sound level at the air discharge port is about 8 dB(A) higher than the unit's sound level.
5. The specifications, designs and information given here are subject to change without notice.
6. Temperature Exchange Efficiency is the mean value between cooling and heating.
7. Efficiency is measured under the following conditions:
Ratio of rated external static pressure has been maintained as follows; outdoor side to indoor side = 7 to 1.
8. In conformance with JIS standards (JIS B 8628), operating sound level is based on the value when one unit is operated, with the value converted for an anechoic chamber. This is transmission sound from the main unit, and does not include sound from the discharge grille. Thus it is normal for the sound to be louder than the indicated value when the unit is actually installed.
9. Sound level from the discharge port causes the value to be approximately 8 dB(A) (models with the airflow rate of less than 150 to 500 m³/h) to approximately 11 dB(A) (models with the airflow rate of 650 m³/h or more) greater than the indicated value. Furthermore, fan rotation and noise from the discharge grille may increase depending on the on-site duct resistance conditions. Please consider noise countermeasures when installing the unit.
10. With large models in particular (1500 and 2000 m³/h models), if the supply air (SA) grille is installed near the main unit, the noise of the main unit may be heard from the discharge grille via the duct, and this will result in a marked increase in noise. In such cases, if peripheral effects are included (such as reverberation of the floor and walls, combination with other equipment, and background noise), sound level may be as much as 15 dB(A) higher than the indicated value. When installing a large model, please provide as much separation as possible between the main unit and the discharge grille. If the equipment and discharge grille are near each other, please consider countermeasures such as the following:
• Use a sound-muffling box, flexible duct and sound-muffling air supply/discharge grilles
• Decentralised installation of discharge grilles
11. When installing in a location with particularly low background noise such as a classroom, please consider the following measures to avoid transmission sound from the main unit:
• Use of ceiling materials with high sound insulating properties (high transmission loss)
• Methods of blocking sound transmission, for example, by adding sound insulating materials around the bottom of the sound source.
Alternatively, consider supplementary methods such as installing the equipment in a different location (corridor, etc.)

OPTIONS

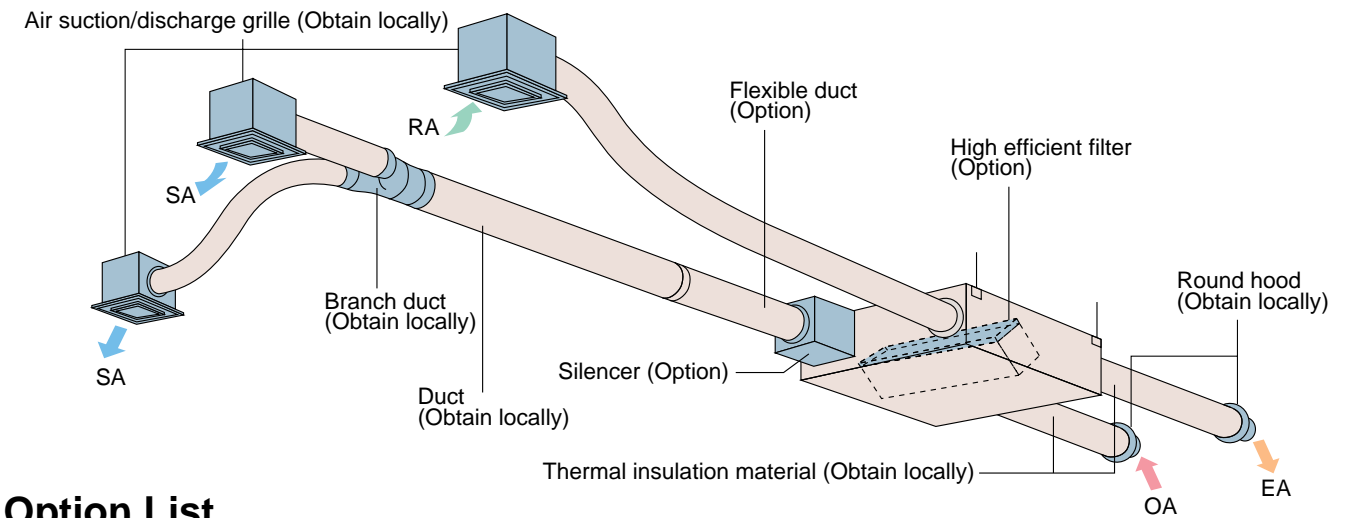

Option List

Item	Type	VAM150 · 250 · 350 · 500 · 650 · 800 · 1000 · 1500 · 2000GJVE												
Controlling device	Heat Reclaim Ventilator remote controller	BRC301B61												
	Centralised controlling device	Central remote controller	DCS302CA61											
		Unified ON/OFF controller	DCS301BA61											
		Schedule timer	DST301BA61											
PC Board Adaptor	Wiring adaptor for electrical appendices	KRP2A61												
	For humidifier	KRP50-2												
	Installation box for adaptor PCB	KRP50-2A90 (Mounted electric component assy of Heat Reclaim Ventilator)												
	For heater control kit	BRP4A50												
	For wiring	Type (indoor unit of VRV)	FXFQ-P	FXZQ-M	FXCQ-M	FXKQ-MA	FXDQ-PB FXDQ-NB	FXMQ-P	FXMQ-MA	FXHQ-MA	FXAQ-P	FXLQ-MA FXNQ-MA	FXUQ-MA	
Installation box for adaptor PCB*		KRP1C63*	KRP1BA57*	KRP1B61*	KRP1B61	KRP1B56*	KRP1C64*	KRP1B61	KRP1BA54	—	KRP1B61	—		
		Notes 2, 3 KRP1H98	Note 4, 6 KRP1BA101	Notes 2, 3 KRP1B96	—	Notes 4, 6 KRP1BA101	Notes 2, 3 KRP4A96	—	Note 3 KRP1CA93	Notes 2, 3 KRP4AA93	—	KRP1BA97		

- Note: 1. Installation box * is necessary for each adaptor marked *.
2. Up to 2 adaptors can be fixed for each installation box.
3. Only one installation box can be installed for each indoor unit.
4. Installation box* is necessary for second adaptor.
5. Installation box* is necessary for each adaptor.
6. Up to 2 installation boxes can be installed for each indoor unit.

Item	Type	VAM150GJVE	VAM250GJVE	VAM350GJVE	VAM500GJVE	VAM650GJVE	VAM800GJVE	VAM1000GJVE	VAM1500GJVE	VAM2000GJVE
Additional function	Silencer	—			KDDM24B50	KDDM24B100				KDDM24A100X2
		—			φ 200		φ 250			
	High efficiency filter	KAF242H25M		KAF242H50M		KAF242H65M	KAF242H80M	KAF242H100M	KAF242H80MX2	KAF242H100MX2
Air filter for replacement	KAF241G25M		KAF241G50M		KAF241G65M	KAF241G80M	KAF241G100M	KAF241G80MX2	KAF241G100MX2	
Flexible duct (1m)	K-FDS101D	K-FDS151D			K-FDS201D				K-FDS251D	
Flexible duct (2m)	K-FDS102D	K-FDS152D			K-FDS202D				K-FDS252D	
Duct adaptor	Nominal pipe diameter mm	—								YDFA25A1
		φ 250								

PC board adaptor for heater control kit (BRP4A50)

When the installation of an electric heater is required in a cold region, this adaptor with an internal timer function eliminates the complicated timer connecting work that was necessary with conventional heaters.

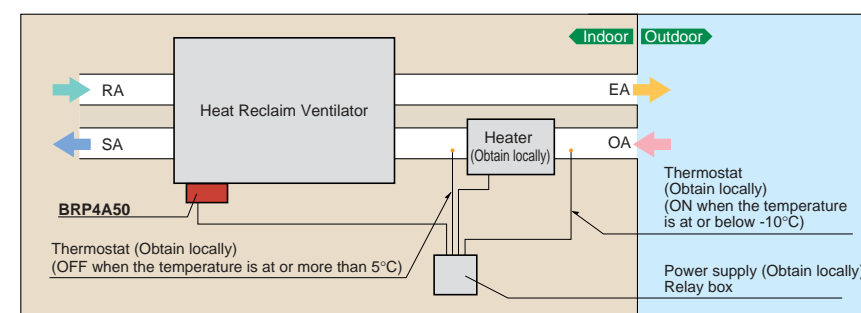

Notes when installing

- Examine fully an installation place and specification for using the electric heater based on the standard and regulation of each country.
- Supply the electric heater and safety production devices such as a relay and a thermostat, etc of which qualities satisfy the standard and regulation of each country at site.
- Use a non-flammable connecting duct to the electric heater. Be sure to allow 2 m or more between the electric heater and Heat Reclaim Ventilator for safety.
- For the Heat Reclaim Ventilator units, use a different power supply from that of the electric heater and install a circuit breaker for each.

