



Catalog 256-13

Rebel™ Commercial Packaged Rooftop Systems

Heating & Cooling
Models DPS 003 – 028
3 to 28 Tons
R-410A Refrigerant
Energy Recovery Wheel



3-6 tons



7-15 tons
Shown with Energy Recovery

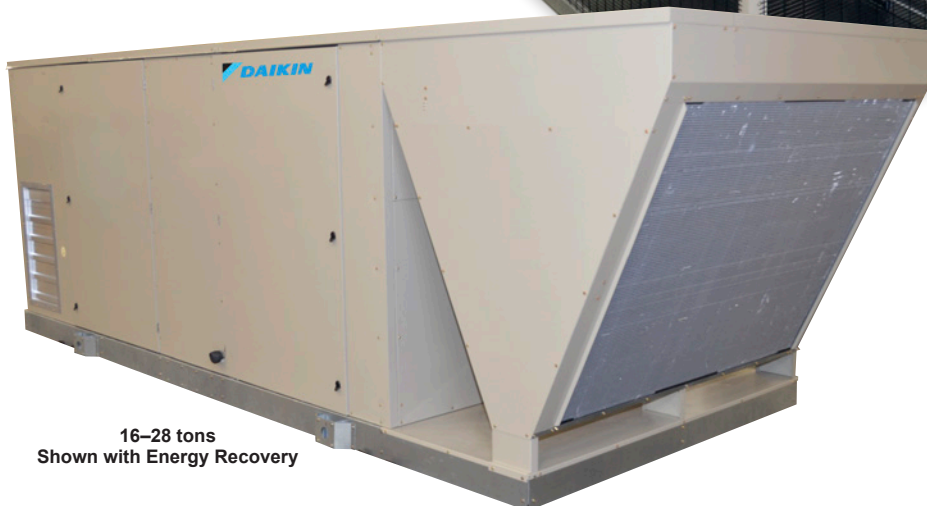

16-28 tons
Shown with Energy Recovery

Introduction	3	Application Considerations	16
Rebel, the most energy efficient packaged rooftop unit.....	3	Unit Location.....	16
Agency Listed.....	3	Service Clearance.....	16
Features and Options	4	Curb Installation.....	16
Cabinet, Casing, and Frame.....	6	Acoustical Considerations.....	21
Compressor.....	6	Ductwork Considerations.....	21
Outdoor Coil.....	7	Return Duct.....	21
Indoor Coil.....	7	Supply Duct.....	21
Heat Pump Heating.....	7	Duct High Limit.....	21
Modulating Hot Gas Reheat.....	8	Vibration Isolation.....	21
Supply Fan.....	8	Smoke and Fire Protection.....	22
Variable Air Volume Control.....	8	Variable Air Volume Application.....	22
Exhaust Fan.....	8	Single Zone Variable Air Volume Application.....	22
Filters.....	8	Fan Operating Range.....	22
Heating Section.....	9	Indoor Fan and Motor Heat.....	22
Gas Furnace.....	9	Altitude Adjustments.....	23
Electric Heat.....	9	Fan Curve Performance.....	23
Hot Water Coil.....	9	Condenser Performance.....	23
Outdoor Air (OA) Monitor and Controller.....	10	Furnace Performance.....	23
Outdoor/Return Air Section.....	11	System Operating Limits.....	23
Energy Recovery Wheel.....	11	Condensate Drainage.....	23
Electrical.....	12	Zone Sensor Placement.....	23
Intelligent Equipment™.....	12	Unit Wiring.....	24
Optional Modulating Hot Gas Reheat	14	Winter Shipment.....	24
Modulating Hot Gas Reheat.....	14	Coil Freeze Protection.....	24
Dehumidification Initiation.....	15	Parallel Air Paths on Energy Recovery Wheel Applications.....	24
Dehumidification Termination.....	15	Economizer Units.....	24
Control & Arrangement.....	15	100% Outdoor Air Units.....	24
		Physical Data	25
		Performance Data	27
		Fan Curves.....	27
		Heating Capacity.....	31
		Air Pressure Drops.....	32
		Dimensional Data	34
		Electrical Data	43
		Engineering Specifications	45

Rebel, the most energy efficient packaged rooftop unit

Daikin Rebel™ commercial rooftop systems provide building owners with energy savings of up to 84% above ASHRAE's 90.1 standard, enabling for complete system payback in under two years. Combining quality manufactured Daikin equipment with advanced Daikin technologies, Rebel delivers a superior commercial rooftop part-load rating of up to 20.6 IEER, making these units ideal for any low-rise commercial building like schools, retail, medical offices, and dedicated outdoor air systems.

Rebel's innovative design utilizes an industry first variable speed Daikin heat pump with hybrid heat (gas, electric, or hot water) options, variable speed ECM motors on all fans, ultra-quiet composite condenser fans, and an advanced modulating variable speed inverter scroll compressor to achieve unprecedented rooftop energy efficiencies.

Configurable as an industry-first VAV heat pump, Rebel offers further configuration flexibility for adverse weather conditions. For much of winter, Rebel's heat pump provides a more economical solution than gas heat. During extreme cold weather, back-up hybrid heat options can be used for additional heat and defrost operation.

Variable speed ECM motors or VFDs on all fans greatly increase system reliability and efficiency by eliminating use of belts. These motors incorporate built-in inverters and ultra-efficient magnetic rotors to save energy at light load conditions.

Composite Daikin condenser fans create ultra-quiet operation, are UV and corrosion resistant, and deliver tremendous energy savings via ECM motors.

Rebel's variable speed Daikin inverter scroll compressor delivers higher energy efficiency ratios and lower energy costs than typical fixed speed, digital scroll, or 2-stage scroll compressors. The Daikin inverter scroll compressor provides true modulating capacity and unsurpassed comfort control

by continuously monitoring and adjusting that temperature. Because the inverter operates and adjusts room temperature only when needed, energy consumption (and noise) drops drastically compared to traditional on/off compressor systems.

Modulating hot gas reheat, electronic expansion valves, economizer, MicroTech® III controls, 100% OA, and more, further contribute to superior efficiencies, enhanced comfort, quiet operation, quality, reliability, and serviceability you expect from the world's leading HVAC manufacturer.

An optional energy recovery wheel transfers both heat and moisture energy between the exhaust and ventilation air. In doing so, it conditions the incoming ventilation air. This total energy device offers a cost-effective and efficient method for containing energy costs while meeting ventilation requirements of ASHRAE Standard 62.1.

Award-winning performance

Since introduction, Rebel's use of those advanced technologies have led numerous system performance awards, such as:

- 2014 Consulting Specifying Engineer Product of the Year Finalist
- 2013 ACHR The News Dealer Design Gold Award
- 2013 Buildings Top Money Saving Products
- 2012 Minnesota Business Innovator of the Year
- 2011 ACHR The News Dealer Design Silver Award

Industry Firsts

- 1st to meet/exceed DOE Rooftop Unit Challenge.
- 1st AHRI certified VAV/air-to-air heat pump.
- 1st rooftop/heat pump with variable speed compressors.
- 1st rooftop/heat pump with electronic expansion valves.

Agency Listed:



Figure 1: Nomenclature

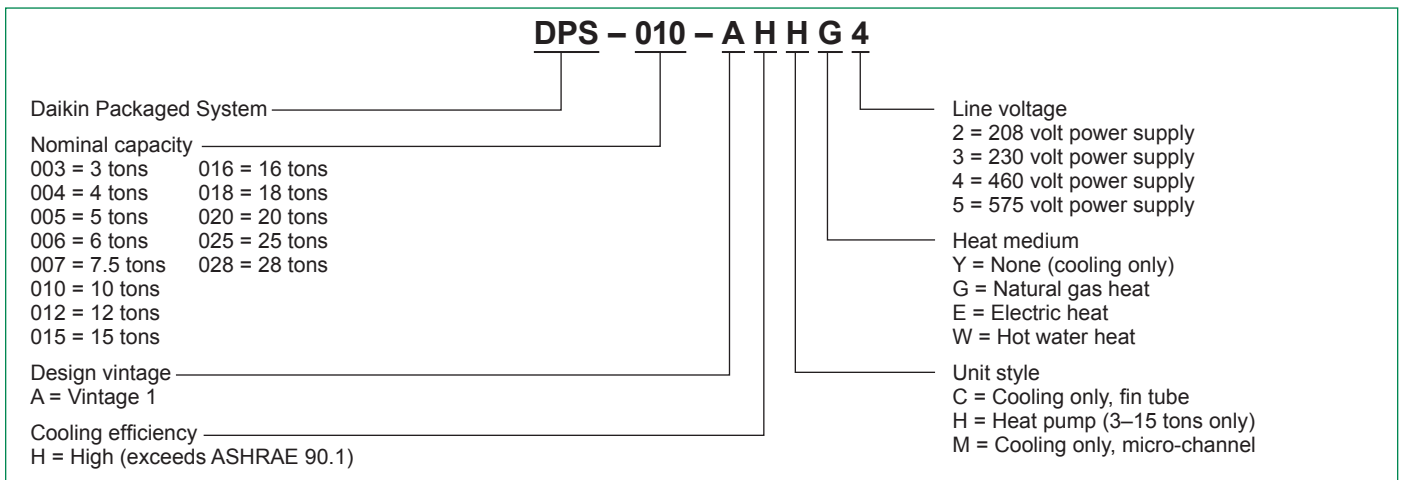

Rebel™ Packaged Singlezone Heating and Cooling Units—Features and Options

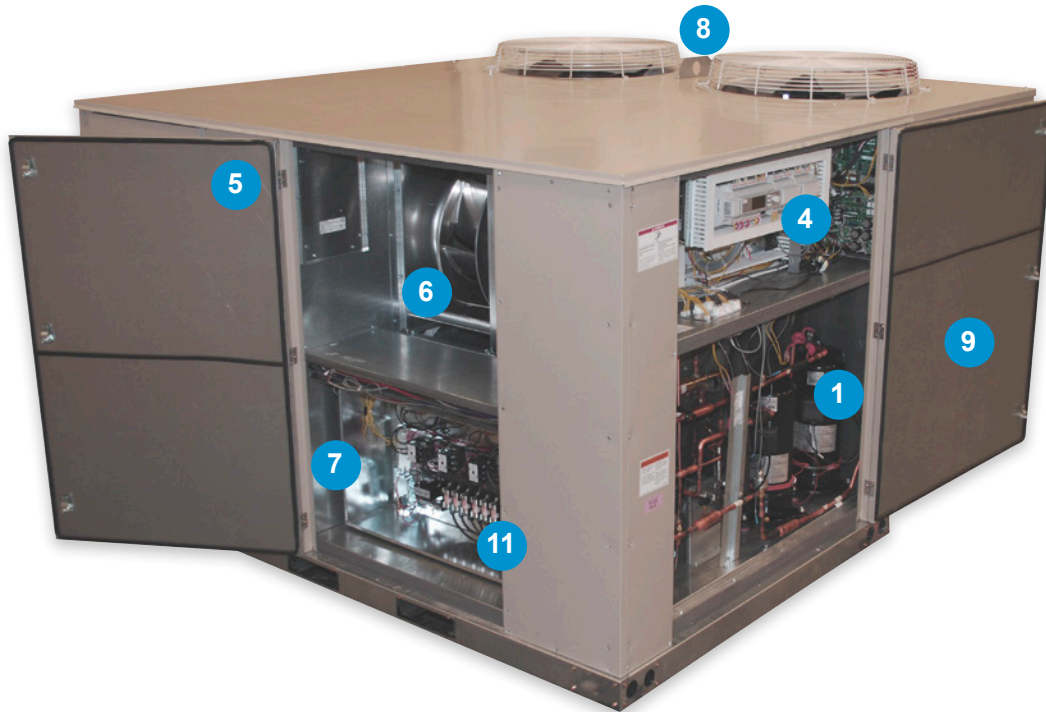

1 Variable speed Daikin inverter compressor

- Modulating capacity allows for optimum comfort control
- Best part-load efficiency in the industry
- Dependable and quiet operation
- Superior discharge air temperature control

2 Variable speed Daikin heat pump

- More economic than gas heat during winter
- Hybrid backup heat options for extreme cold weather and defrost operation
- Modulating capacity delivers the industry's best heat pump control

3 Electronic expansion valves

- Optimum control of superheat
- Protects compressor from liquid refrigerant
- Increases efficiency by safely lowering head pressure

4 MicroTech® III unit controller

- Open Choices™ feature provides interoperability with BACnet®, Daikin D3 and LONWORKS® communication options for easy integration with building automation systems
- Unit diagnostics for easy serviceability
- Outdoor air and humidity control logic maintains minimum fresh air intake and optimum humidity levels
- Optionally add the Intelligent Equipment™ control solution, which provides real-time data streams for benchmarking performance, monitoring system operations and implementing remote diagnostics and control

5 Hinged access doors

- ¼–turn latch door provide easy access to system components for maintenance and service

6 Variable speed ECM motors or VFDs on all fans

- Greatly increases system reliability and efficiency eliminates belts and bearing setscrews
- Saves energy at light load
- Built-in inverter eliminates control panel heat

7 Hybrid backup heat options

- Gas furnace with turndowns as high as 10:1
- Electric heat option with SCR for precise temperature control
- Hot water heat

8 Ultra-quiet Daikin condenser fans

- One-piece composite blade design for noiseless operation
- UV and corrosion resistant
- Variable speed ECM motors provide tremendous energy savings at lower ambient

Rebel™ Packaged Singlezone Heating and Cooling Units—Features and Options



- 9 Double-wall foam cabinet**
 - No exposed insulation to the air stream
 - Better thermal seal than fiberglass
- 10 Dehumidification Control**
 - Hot gas used for “free” reheat
 - Tight humidity control without over cooling the space
 - Modulating hot gas reheat coil
- 11 Stainless steel, double sloped drain pan**
 - Prevents corrosion
 - Avoids standing water for high IAQ
- 12 100% outdoor air option**
 - Low-leak dampers
 - Double-wall blades, edge and jam seals
 - Modulating 100° temperature rise furnace
 - Modulating compressor
 - Modulating hot gas reheat

- 13 Durable construction**
 - Foam-injected panels with an R-value of 7 (3–15) or 13 (16–28)
 - Increased insulation value for increased system efficiency
 - Double-wall construction for increased indoor air quality
- 14 Low radiated noise**
 - Enclosed compressor
 - Quiet outdoor fan
 - Excellent acoustics at lower speeds
- 15 Economizer**
 - Provides free-cooling when outdoor conditions are suitable
 - Provides fresh air to meet local requirements
 - Integrated economizer operating with mechanical cooling
 - Optional demand control ventilation for increased system efficiency

- 16 2" and 4" slide-out filter racks**
 - Easy filter changeouts for quick serviceability
 - 2" MERV 8 filters are provided
- 17 Optional energy wheel**
 - Meets ASHRAE 90.1-2010 effectiveness requirements
 - Factory installed and tested
 - Single-point power

AHRI 340/360 Certified
 Rebel capacity and efficiency is independently certified by rigorous annual witness testing.

Daikin Rebel rooftop units are built to perform, with features and options that provide for lower installed and operating costs, superior indoor air quality, quiet operation and longevity.

Cabinet, Casing, and Frame

Unit Panel construction includes double-wall with galvanized steel liner to enhance performance and satisfy IAQ requirements.

Figure 2: Durable, Double-wall Construction

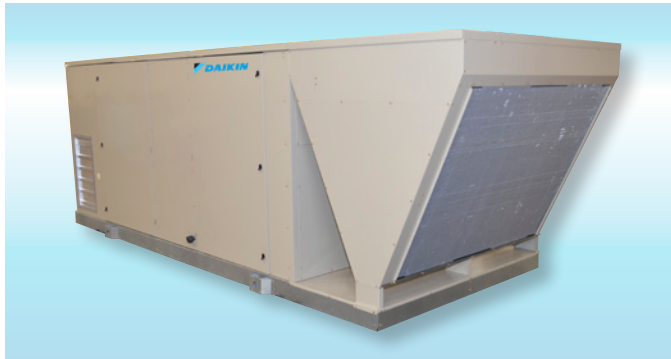

- Heavy-duty lifting brackets are strategically placed for balanced cable or chain hook lifting
- Insulated floor panels have a solid galvanized steel inner liner on the air stream side of the unit to protect insulation during service and maintenance
- 2 part injected foam insulation have an R-value of 7.0 (3–15 ton) or 13.0 (16–28 ton) for long equipment life and better acoustics
- Panel design includes no exposed insulation edges
- Unit cabinet can operate at total static pressures up to 5.0 inches of water
- Pre-painted galvanized steel exterior surfaces withstand a minimum 750-hour salt spray as per ASTM B117 provides unit for long term durability
- Access doors include multiple, stainless steel hinges and ¼ turn latch system for easy access
- The unit base overhangs the roof curb for positive water runoff and seats on the roof curb gasket to provide a positive, weather tight seal

Compressor

High performance, low noise inverter scroll compressors, adjust the speed to match required total cooling and heating load for efficient part load control.

Figure 3: Inverter Scroll Compressor Technology

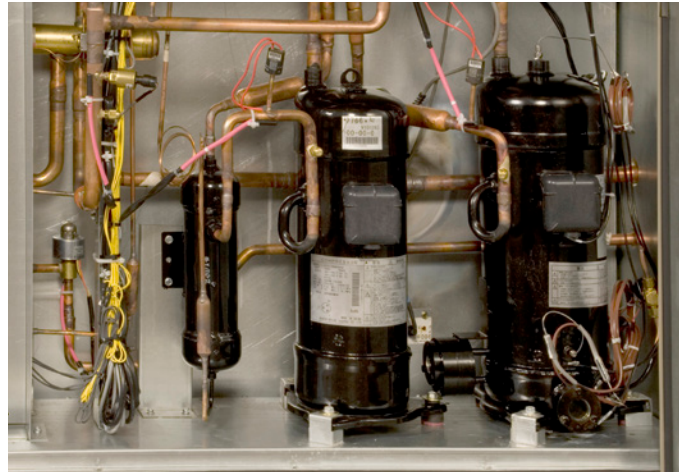

- The inverter scroll compressor has permanent magnets for high torque and maximum efficiency. At complete stop of the compressor, the magnets will position the rotor into the optimum position for a low torque start
- Refrigeration circuit includes both a low and high pressure transducer, high pressure safety switch and temperature sensors for the suction and discharge. All of the above devices are input to the unit controller and the values be displayed at the unit controller. Crankcase heaters and external thermal overload protection are also provided for compressor durability
- Refrigerant circuit includes a bypass valve between the suction and discharge refrigerant lines for low head pressure compressor starting and increased compressor reliability
- Unit is factory charged with environmental friendly and sustainable R-410A refrigerant
- The compressor is mounted on isolators for quieter operation
- Superior oil management is provided in one of two ways:
 - 3–15 tons, oil separators are provided at the discharge piping of each compressor
 - 16–28 tons, the inverter compressor has a low oil safety control

Outdoor Coil

All heat pump units use large face area outdoor coils, with integral sub-cooling circuit, are constructed with seamless copper tubes, mechanically bonded into aluminum plate-type fins with full drawn collars to completely cover the tubes for high operating efficiencies.

Most non-heat pump units use large face area, all aluminum, micro-channel coils with integral subcooling circuits. Size 5 and 6 units use fin tube coils. Micro-channel coils allow significant charge reduction and reduced maintenance costs.

Figure 4: Flexible Outdoor Coils Designed for Heat Pump or Cooling Only Operation

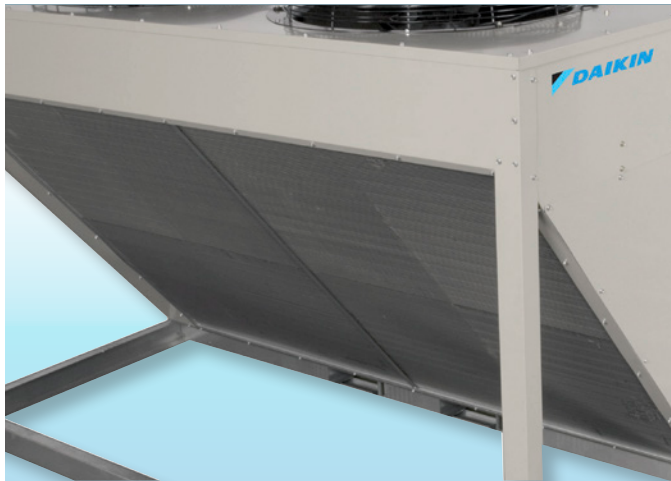

- Each outdoor air coil is factory leak tested with high-pressure air under water for reliable operation.
- Units are shipped with full operating charge of R-410A for quick start up
- The condensing unit consists of one or more direct drive condenser fans with low noise, patented profile blade design for quieter operation
- Fan motors have an ECM type motor for proportional control to make sure the space condition are met at ambient condition of 0–120°F
- A PVC coated, cross-welded, steel wire, coil guard is offered to provide protection for outdoor coil fins as an option
- Thermal overload and phase failure protection are provided for dependable and long lasting motor operation.
- The fan motor, include permanently lubricated bearings to reduce maintenance cost
- Sloped condenser coil design provides better hail protection for durability and reliable performance

Indoor Coil

Indoor coil section is installed in a draw through configuration to provide better dehumidification.

- Direct expansion cooling coils are fabricated of seamless rifled copper tubing that is mechanically expanded into enhanced aluminum plate fins for high efficiency
- Multi-row, staggered tube design coils with a minimum of 3 rows allow unbeatable part load and full load efficiencies
- Cooling coil includes an electronic controlled expansion valve to maintain the liquid sub-cooling and the superheat of the refrigerant system for extreme ambient conditions
- Each indoor air coil is factory leak tested with high-pressure air under water and completely piped and charged for quick start up and reliable operation
- Cooling coil is mounted in a stainless steel and positively sloped, ASHRAE 62.1 compliant, double sloped drain pan to improve IAQ

Figure 5: Rebel Indoor Coil Section

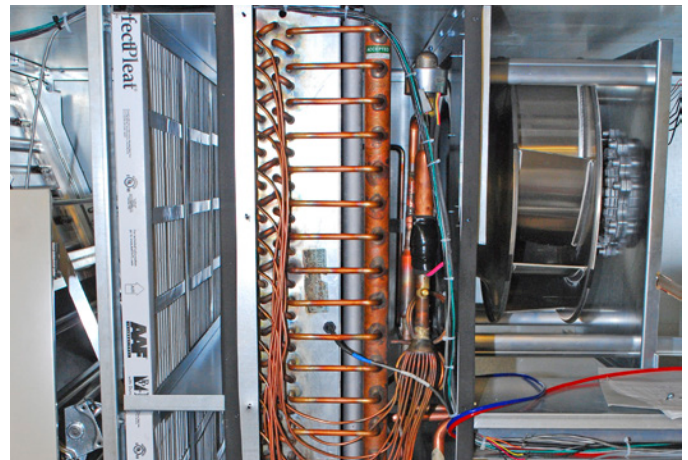

Heat Pump Heating

Evaporator coil, condenser coil, compressors and refrigerant circuit are designed for heat pump operation.

- The refrigerant circuit contains a 4 way reversing valve to provide heat
- The outdoor coil includes an electronic controlled expansion valve to control the refrigerant flow during heat pump operation
- The unit controller modulates the expansion valve to maintain compressor operation within the compressor operational envelope
- Hybrid heating option is provided for auxiliary
- The refrigerant system includes a pump-down cycle for durable operation

Modulating Hot Gas Reheat

All aluminum fully modulating hot gas reheat coil is provided for dehumidification control.

- Hot gas reheat coil includes aluminum tube micro channel design with high efficiency brazed aluminum fins for direct bonding and provides better heat transfer
- Modulating reheat coil provides precise temperature and humidity control to maintain required space conditions and reduces the chances of mold growth, sick building syndrome
- MicroTech III integrated controls with compressor and reheat coil energizes whenever dehumidification is needed without using additional energy
- Each indoor air coil is factory leak tested with high-pressure air under water and completely piped and charged for quick start up and reliable operation

Supply Fan

The airfoil single width, single inlet (SWSI) Class II construction supply fan with aluminum fan blades provides efficient and quiet operation at wide ranging static pressure and air flow requirements.

- Fan wheel is continuously welded to the hub plate and end rim for long lasting reliable operation
- Direct drive fan with no belts, sheaves, or bearings and permanently lubricated motors provides low maintenance cost
- Each fan assembly is dynamically trim balanced at the factory before shipment for quick start up and efficient operation
- MicroTech III integrated controls modulate the supply fan motor
 - 3–15 ton units use ECM motors
 - 16-28 ton units use VFDs
- Motor with thermal overload and phase failure protection is provided for motor long lasting operation

Variable Air Volume Control

MicroTech III proportionally controls the ECM motors or VFDs on the supply and exhaust fans, not only reduce fan energy and operating cost at part load conditions but also improves sound levels. Two supply fan control methods are offered:

- Fan motor speed is controlled by the unit controller based on space temperature for singlezone VAV applications
- Fan motor speed is controlled by the unit controller based on a duct static pressure sensor for traditional VAV applications

Exhaust Fan

Single width, single inlet (SWSI) Class II airfoil fans with aluminum blades provide efficient and quiet operation at wide ranging static pressure and air flow requirements.

- Fan wheel is continuously welded to the hub plate and end rim for long lasting, reliable operation
- Direct drive fan with no belts, sheaves, or bearings and permanently lubricated motors provides low maintenance cost
- Each fan assembly is dynamically trim balanced at the factory before shipment for quick start up and efficient operation
- MicroTech III integrated controls modulate the totally enclosed EC premium efficiency motor for efficient part load control
- Motor with thermal overload and phase failure protection is provided for motor long lasting operation

Filters

Unit provides a draw-through filter section

- Both 2" – 4" filter tracks are provided to accept a 2"pre filter and a 4"after filter. MERV 8 prefilters are provided
- The filter section includes hinged access door equipped with ¼ turn latch for easy access

Figure 6: Easy Access Filters



Heating Section

Wide ranging natural gas, electric, hot water heat selections effectively handle almost any heating demand from morning warm-up control to full heat.

Figure 7: Gas Furnace

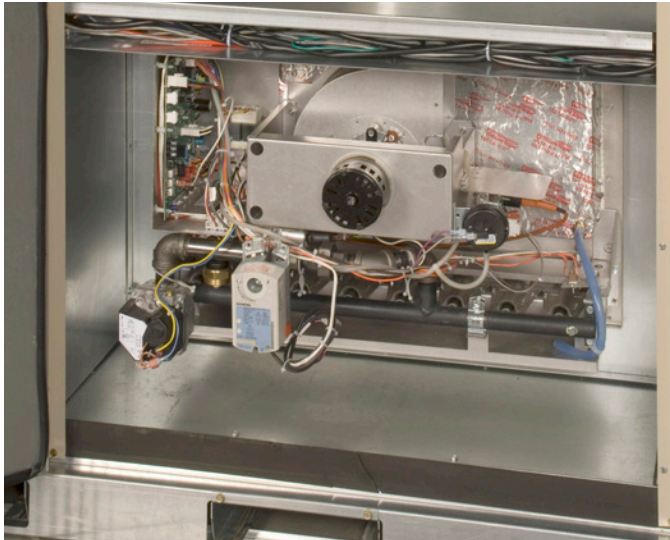

Gas Furnace

ETL certified heating modules provide a custom match to specific design requirement.

- Two stages, 5:1 or 10:1 modulating heating control provides the flexibility to solve diverse needs
- User has the flexibility to order heat exchanger tubes with 20 Gauge, G160, aluminized steel or stainless steel to meet your application needs
- The furnace has a tubular design with in-shot gas burner manifold and is installed downstream of the supply fan
- The module contains an induced draft fan that will maintain a negative pressure in the heat exchanger tubes for the removal of the flue gases to protect indoor air quality
- Each burner module provides flame roll-out safety protection switches and a high temperature limit switch for reliable operation
- Induced draft fan includes an airflow safety switch to prevent heating operation in the event of no airflow for occupant safety
- All burner assemblies are factory tested and adjusted prior to shipment
- Heating control is fully integrated into the unit's MicroTech III control system for quick startup and reliable control
- Optional field installed LP kits are available for staged heating modules

Electric Heat

ETL approved electric heat is factory assembled, installed and tested.

- Heating control is fully integrated into the unit's MicroTech III control system for quick startup and reliable control
- Multi-stage or SCR capability for application flexibility
- Durable low watt density, nickel chromium elements provide longer life
- Fuses are provided in each branch circuit to a maximum of 48 Amps per NEC requirements
- Single point power connection reduces installation cost
- For operational safeties electric heat includes automatic reset, and high temperature limit safety protection and an airflow safety switch to prevent electric heat operation in the event of no airflow

Figure 8: Electric Heat Coils

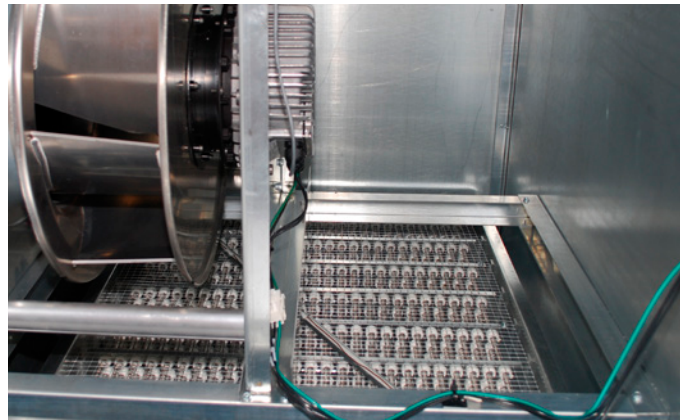

Hot Water Coil

1 and 2-row, low and high output options (3-row available for 16–28 ton units).

- Fully cased coil for better serviceability
- Factory installed coil vent and drain
- Piping vestibule for field installed piping control package
- Unit DDC control provides freeze protection and remote alarm signal
- DDC control ready with 2–10 volt wiring harness for field supplied and installed valve
- Each indoor air coil is factory leak tested with high-pressure air under water for reliable operation

Outdoor Air (OA) Monitor and Controller

Directly measures and controls outdoor ventilation air flow as low as 15 CFM per ton in order to improve indoor air quality (IAQ).

Model	Unit Size (tons)	Minimum CFM
Rebel	3-6	100
	7-15	200
	16-28	400

Thermal dispersion technology, independently calibrated sensors using NIST traceable standards, and laboratory testing of the entire assembly allow ventilation control accuracy of +/- 15%.

This outdoor air monitor is ideal for low velocity ventilation control, sensitivity to air flow increases as flow rate decreases, and accuracy is a percent of reading. Competitive pitot tube and pressure drop alternatives have very little sensitivity at low velocities and accuracy is a percent of full scale readings.

Monitor and controller comply with the measurement portion of the Outdoor Air Delivery Monitoring LEED® Point EQc1.

This option is factory installed, calibrated and tested to reduce installation costs and risks. End-users only need to enter the outdoor air flow set point into the MicroTech® III controller.

OA Monitor/Controller Application

The outdoor air monitor measures the airflow and sends the appropriate analog signal to the MicroTech III controller, which in turn modulates the outdoor air damper to maintain proper ventilation levels. The desired outdoor air flow set point is directly entered at the MicroTech III controller keypad or is read from the BAS.

Measured outdoor air CFM can be displayed on the MicroTech III controller, as well as the outdoor air monitor, and MicroTech III writes this value to the BAS.

All BAS communication is done through the optional, MicroTech III, LON®, or BACnet® communication cards.

The outdoor air monitor option is available on all economizer, 100% outdoor air, and energy recovery options as well as the 0-30% outdoor air option.

Control accuracy may exceed +/- 15% when the energy recovery wheel bypass dampers are open. This only occurs during economizer operation, at which time more than enough ventilation air is provided.



OA Monitor



OA Controller

Outdoor/Return Air Section

Rebel units are available with a 0% to 30% outdoor air damper or a 0% to 100% economizer or also a 100% outdoor air option.

- Outside air intake hood constructed from painted galvanized steel for longer equipment life
- Outside air hood includes moisture eliminator filters to prevent water from entering the unit for better IAQ
- Vinyl gasketed, motorized blade dampers provides efficient operation by reducing leakage during OFF cycles
Damper leakage is 1.5 cfm per square foot at 1" pressure. ASHRAE 90.1 minimum damper leakage is 267% greater than Rebel's damper leakage
- 0% to 30% damper is field adjusted to a fixed open position that is easily set using the MicroTech III keypad, allowing for a balance between IAQ and energy savings
- 0% to 100% option includes outside and return air dampers sized to handle 100% of the supply air volume for efficient and reliable operation
- 0% to 100%, fully functional, modulating economizer provides free cooling and reduces compressor energy and operating cost
- Economizer control is fully integrated into the unit's MicroTech III control system and features a spring-return actuator, adjustable minimum outside air set point and adjustable changeover
- Dry bulb or comparative enthalpy economizer changeover control is available to provide the most economical amount of outside air for "free" cooling
- Barometric relief dampers are standard for exhaust control and exhaust air out of the back of the unit and also include bird screen to prevent infiltration

Energy Recovery Wheel

Daikin energy wheels normally recover 70-75% of both sensible and latent energy. Considerable energy savings can result:

- Provide twice as much summer energy recovery as sensible-only alternatives, such as plate frame heat exchangers or run-around loops
- Energy recovery can increase the air conditioning capacity by 25% if the minimum outdoor air design is 33%. The cost savings on mechanical heating and cooling components offset the additional investment of energy recovery
- Winter humidification energy costs may be cut up to 60%
- Winter latent energy recovery lowers the dew point of exhaust air, compared to sensible-only alternatives, and allows frost-free operation to a lower ambient temperature
- Optional energy recovery wheel for increase efficiency for conditioning minimum outdoor air
- Unitary design for installation/rigging cost savings
- Single point power connection for decreased installation cost
- Slide-out wheel cassette & track for easy maintenance and cleaning
- Bypass dampers for increased efficiency during economizer operation
- Integrated unit control for control coordination between rooftop unit and wheel that controls the wheel speed
- Leaving wheel temperature sensors for wheel operation monitoring
- Integrated unit control with optimum leaving wheel temperature control to prevent over-heating the outdoor air
- Defrost options including ON/OFF control, Start/Stop and VFD speed modulation
- MERV 8 prefilters provided on outdoor and return air paths minimize dirt and cleaning

Figure 9: Energy Recovery Wheel

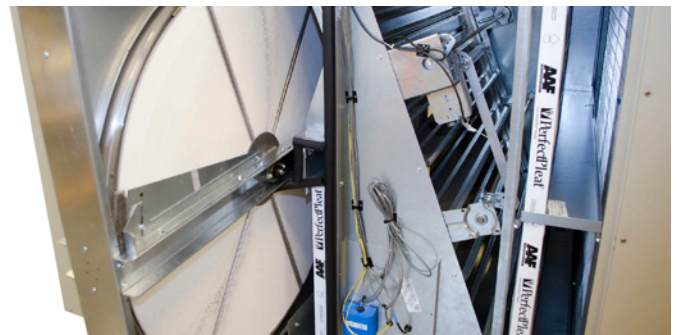

Electrical

Units are completely wired and tested at the factory to provide faster commissioning and start-up.

- Wiring complies with NEC requirements and all applicable UL standards
- For ease of use, wiring and electrical components are number coded and labeled according to the electrical diagram
- A 115 V GFI convenience receptacle requiring independent power supply for the receptacle is optional
- An optional unit powered 20 amp 115 V convenience receptacle, complete with factory mounted transformer, disconnect switch, and primary and secondary overload protection, eliminates the need to pull a separate 115 V power source
- Supply air fan, compressor, and condenser fan motor branch circuits have individual short circuit protection. Unit includes knockouts in the bottom of the main control panels for field wiring entrance
- A single point power connection with power block is standard and a terminal board is provided for connecting low voltage control wiring
- 115-volt control circuit transformer and fuse, system switches, and a high temperature sensor are provided with the unit
- For better serviceability an optional non-fused disconnect switch is optionally mounted inside the control panel and operated by an externally mounted handle for disconnecting electrical power at the unit

Intelligent Equipment™

Intelligent Equipment (IE) from Daikin Applied is a secure, cloud-based controls solution that enables delivery of equipment and/or system information to customers via web or mobile devices.



A power measurement module and communications gateway installed on Daikin equipment enables the unit to be directly connected to the Internet via wireless (cellular, WI-FI) or local area network (LAN), providing management, monitoring control analysis and decision-making functionality for Daikin rooftop systems and the facility.

Features

- Remote monitoring and control of Daikin rooftop units
- Remote servicing capabilities
- Integration to the Energy Star® Portfolio Manager®
- Advanced data analytics including equipment performance, financial performance and building Comfort Index matrix based on ASHRAE Standard 55-2010
- Dynamic user dashboards with photo-realistic graphics and responsive-design interface optimized for users' mobile devices, tablets or PCs
- Secure, role-based user access

Benefits

- Informed decision-making
- Increased equipment efficiency
- 24/7 monitoring capability
- Real-time equipment information
- Accelerated equipment payback
- Historical performance data
- Can be used with, or without, an existing building automation system (BAS)

Also see [ASP 31-384](#) for more details.

Figure 10: Intelligent Equipment Dashboards

Customer Dashboard

The Customer Dashboard provides a comprehensive overview of building performance. It includes sections for Building Status (Energy Star Score 100, Usage Comparison), HVAC Summary (Unit Status: No Alarm, Maintenance: Not Needed, Live Power Usage: 0.45%), and a detailed view for RTU-2. The RTU-2 view shows a 95% Comfort Index, a Sustainability Index of 1.0, and a graph of Relative Humidity (%) vs. Space Temperature (°F). It also features energy-saving recommendations and a sustainability index.

Technician Dashboard

The Technician Dashboard is designed for service personnel. It displays an 'Alarm Cleared / No Active Alarms' message and provides a detailed 'Overview Live Data' for the RTU-4 unit. The unit overview includes Discharge Air Temperature (72.7 °F), Return Air Temperature (60.9 °F), and various system settings like Heating, Economizer, Cooling, and Power Usage. A detailed 'Overview' section shows a 3D model of the RTU-4 with numbered callouts (1-7) pointing to key components: 1. ERW, Economizer & Filter Access; 2. Coil Access Panel; 3. Supply Fan & Gas Heat Access; 4. Gas Connection; 5. Condensate; 6. Control Panel; 7. Inverter Panel. An 'Upcoming Maintenance' alert indicates that the RTU-4 is scheduled for weekly, bi-monthly, monthly, four times a year, and annual maintenance.

Modulating Hot Gas Reheat

The reheat coil comes complete with an aluminum micro-channel coil and modulating hot gas valves for leaving air temperature control.

On a call for dehumidification, the unit controls will modulate the compressor to maintain desired DX coil leaving air temperature and dew point. Hot gas from the unit condenser will be routed to an indoor coil downstream of the DX coil to reheat the air. Hot gas reheat valves (Figure 11) will control how much hot gas is routed to the indoor coil to maintain desired discharge air temperature from the unit.

Figure 11: Dual 2-Way Modulating Valve Refrigeration Schematic (Cooling Model Shown)

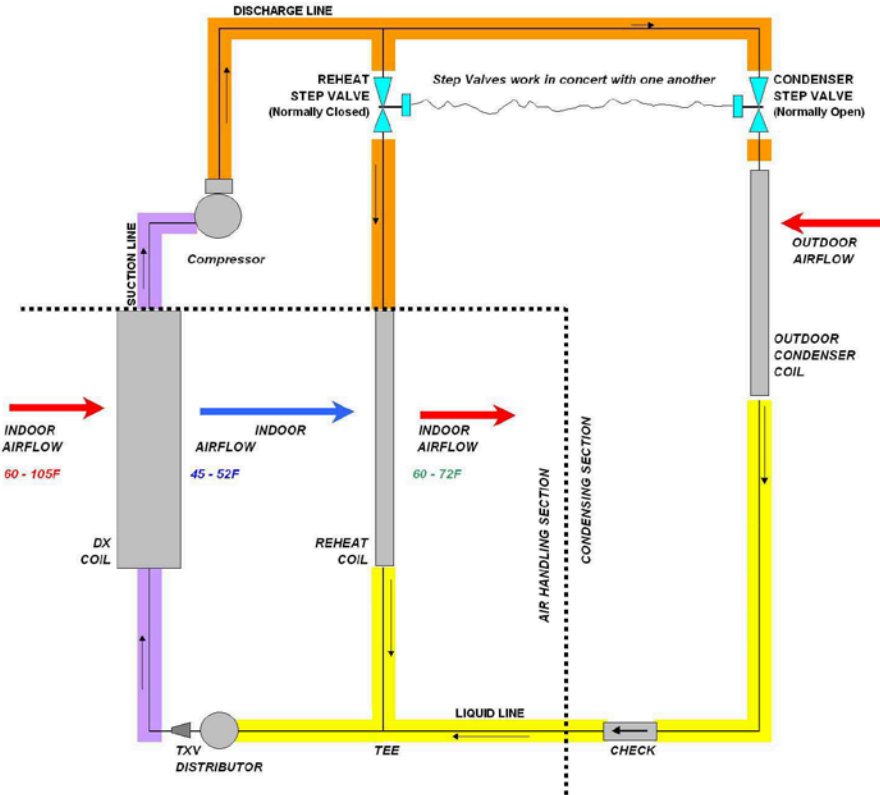
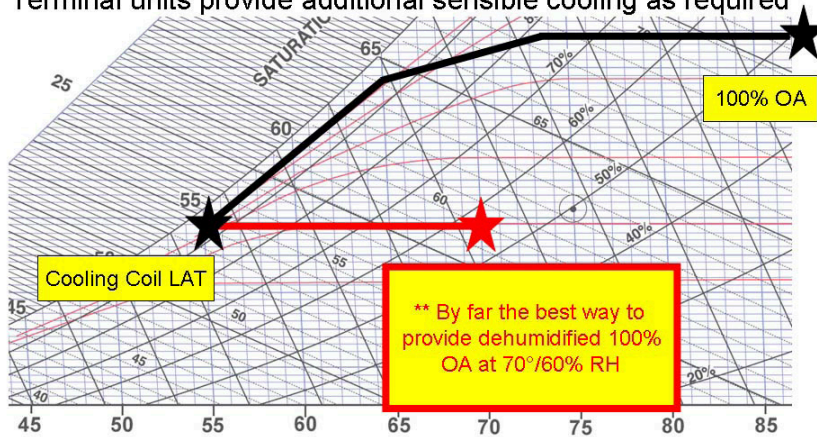

Figure 12: Ideal for Neutral Air Ventilation Control

- The rooftop mainly dehumidifies the required ventilation air
- Terminal units provide additional sensible cooling as required



Dehumidification Initiation

An analog sensor is mounted in the return duct, the space, or outdoors to sense relative humidity. The location is selected by setting the sensor location value on the keypad to return, space, or Outdoor Air Temperature. Outdoor Air Temperature can only be selected for units with Discharge Air Temperature control. Dehumidification is disabled when the unit is in either the heating or minimum Discharge Air Temperature state. When dehumidification is enabled, dehumidification operation is initiated when humidity control is set to either relative humidity or dew point and that value rises above the appropriate setpoint by more than half of its deadband. Economizer operation is disabled in the dehumidification mode so the unit immediately transitions to cooling if dehumidification is initiated in economizer state.

Dehumidification Termination

Dehumidification is terminated if the selected variable, relative humidity or dew point, drops below the appropriate humidity setpoint by more than half its deadband. Dehumidification is also terminated if cooling is disabled for any reason or the unit enters either the heating or minimum Discharge Air Temperature state. Compressor capacity is reduced and eventually shut off when compressor cycle timers are satisfied.

Control & Arrangement

In conjunction with dehumidification, MHGRH is used to raise the temperature of the cooled air to a desirable value. MHGRH is comprised of a parallel coil arrangement, with dual modulating reheat valves (which operate in concert with one another) and a check valve.

During dehumidification control with modulating hot gas reheat (MHGRH), an analog signal (0-10Vdc) is controlled as described below.

- A PI loop is used to control the HGRH valves to maintain the discharge air temperature from the reheat coil
- Compressor staging and speed during reheat (or dehumidification) will be controlled by the leaving DX coil temperature. For increased dehumidification during reheat, the standard default compressor staging range is 45–52°F
- When dehumidification is active in the cooling state, the reheat set point equals the Discharge Air Temperature cooling setpoint. For Discharge Air Temperature units, this is the normal Discharge Air Temperature set point resulting from any reset. For zone control units, this set point is the result of a PI loop based on the control temperature
- Communication with the reheat control valves is accomplished by providing a 0–10 Vdc signal to a pair of interface boards which in turn supply the control signal to the reheat valves (step type)

- In the fan only state, no sensible cooling is required, but dehumidification mode will still be enabled if the dew point or humidity sensor is not satisfied. Reheat set point varies from a maximum value (default 65°F) when the control temperature is at or below the heating changeover setpoint to a minimum value (default 55°F) when the control temperature is at or above the cooling changeover setpoint
- In the reheat mode, the minimum position for the reheat valves is 10% (1.0 Vdc). The controller will modulate the reheat valves from this starting position
- Reheat valve(s) must be at 0% (0 Vdc) position before starting the first compressor in the reheat circuit to prevent pressure spikes
- Upon termination of dehumidification (reheat), the maximum ramp down or decay rate of the reheat control valves shall be 1% per sec (or 0.1V per sec)
- Upon termination of dehumidification (reheat), staging of compressor(s) is delayed for 1 minute after reheat capacity = 0% (0 Vdc)
- Every 24 hours, the reheat control valves will be driven to their maximum position (10Vdc) and then returned to their normal operating position (0Vdc). If unit is operating in cooling or dehumidification (reheat) at the prescribed time it will be deferred to the next time
- Dehumidification status can now be found under the MicroTech III main system menu. Reheat capacity (valve position) can also be found under the main system menu, display based on percentage (0-100%)

Daikin Rooftop units are intended for use in normal heating, ventilating, and air conditioning applications. Consult your local Daikin sales representative for applications involving operations at high ambient temperatures, high altitudes, non-cataloged voltages, or for job specific unit selections that fall outside of the range of the catalog tables.

For proper operation, units should be rigged in accordance with instructions stated in IM 1125. Fire dampers, if required, must be installed in the ductwork according to local and/or state codes. No space is allowed for these dampers in the unit. Follow factory check, test and start procedures explicitly to achieve satisfactory start-up and operation (see IM 1125). Most rooftop applications take advantage of the significant energy savings provided with economizer operation. When an economizer system is used, mechanical refrigeration is typically not required below an ambient temperature of 50°F. Standard DPS refrigeration systems are designed to operate in ambient temperatures down to 25°F.

Unit Location

The structural engineer must verify that the roof has adequate strength and ability to minimize deflection. Take extreme caution when using on a wooden roof structure. Unit condenser coils should be in a location that avoids any heated exhaust air.

Allow sufficient space around the unit for maintenance/service clearance. Refer to [Figure 13 on page 17](#) for recommended clearances. Consult your Daikin sales representative if available clearances do not meet minimum recommendations. Where code considerations, such as the NEC, require extended clearances, these take precedence.

Service Clearance

Allow for recommended service clearances as shown in [Figure 13](#). Provide a roof walkway along the sides of the unit for service and access to controls and components. Contact your Daikin sales representative for service requirements less than those recommended.

Curb Installation

The roof curb is field-assembled and must be installed level (within 1/16" per foot side to side). A sub-base must be constructed by the contractor in applications involving pitched roofs. Gaskets are furnished and must be installed between the unit and curb. For proper installation, follow NRCA guidelines. Typical curb installation is illustrated in [Figure 14 on page 18](#) and [Figure 15 on page 19](#).

In applications requiring post and rail installation, an I-beam securely mounted on multiple posts should support the unit on each side. In addition, the insulation on the underside of the unit should be protected from the elements.

Applications in geographic areas subjected to seismic or hurricane conditions must meet code requirements for fastening the unit to the curb and the curb to the building structure.

Figure 13: Service Clearances

**Small Cabinet
003—006**

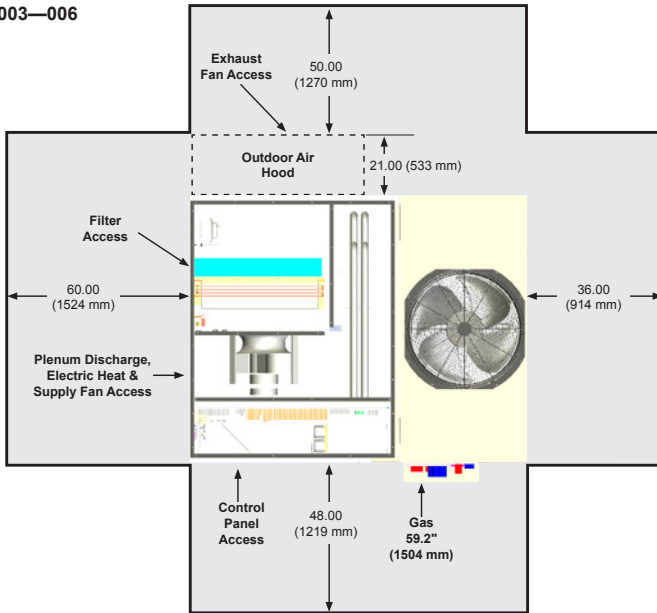

**Medium Cabinet
007—015**

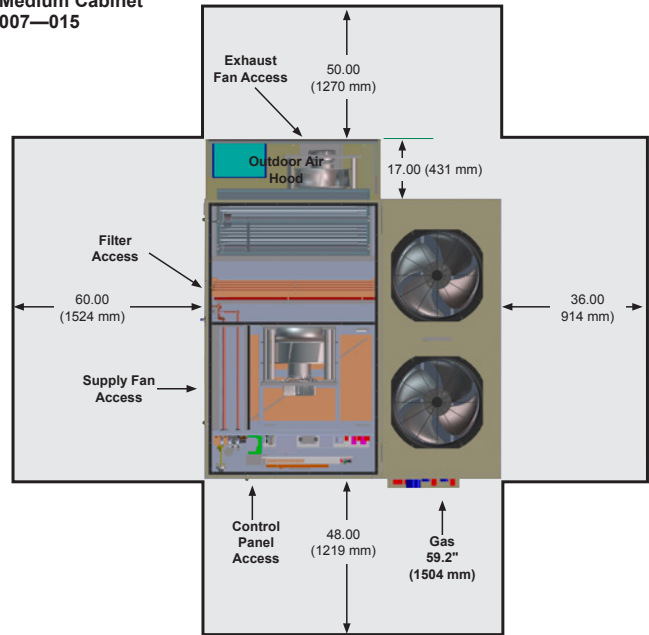

**Large Cabinet
016—028**

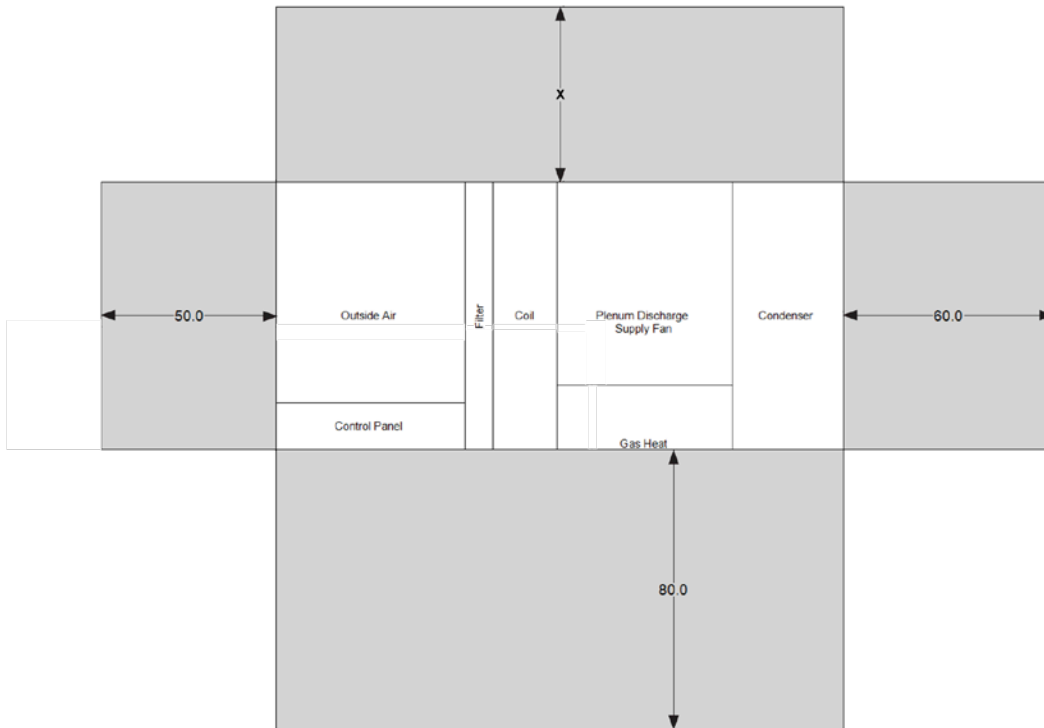

NOTES:

1. Center of gravity height = 34.1"
2. Total weight = 4001 lbs.
3. X = 60" with ERW, 50" without ERW

Figure 14: Roof Curb Assembly (DPS 003—006)¹

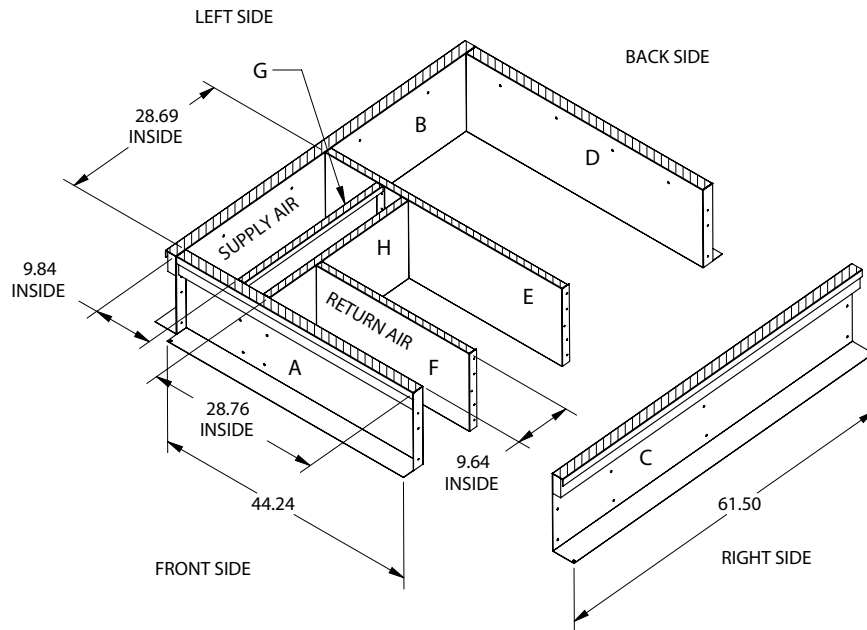

- NOTE:**
1. Check submittal drawing for gas/water/electrical/supply/return air opening
 2. Horizontal above the roof gas connection only
 3. All dimensions in inches

Standard Roof Curb – Small Cabinet

Roof Curb for ERW – Small Cabinet

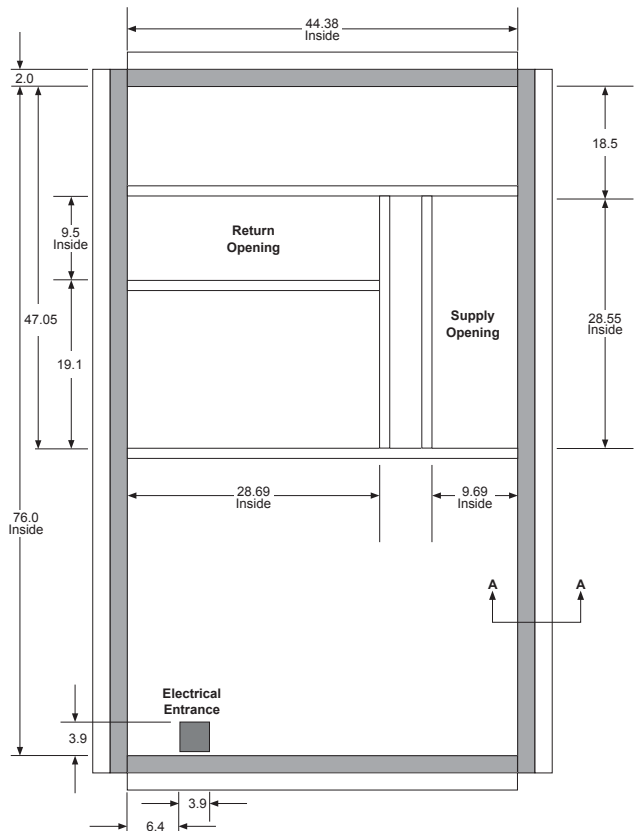
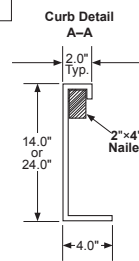
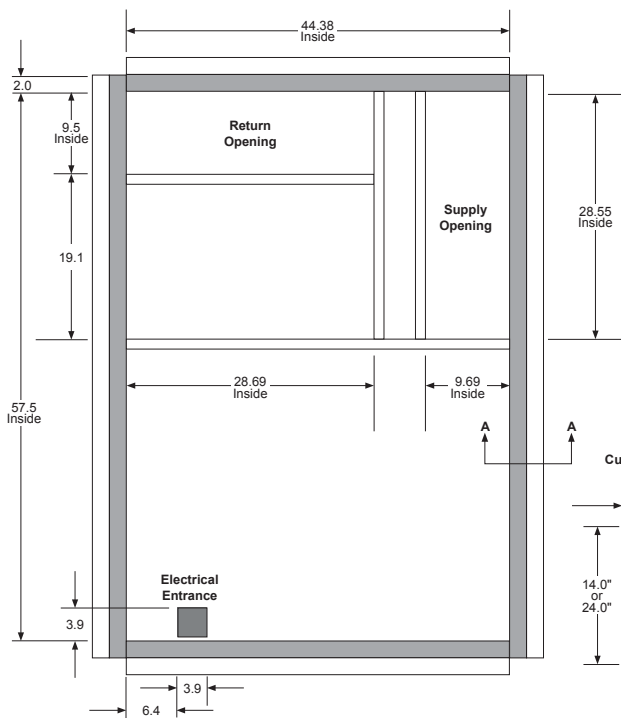
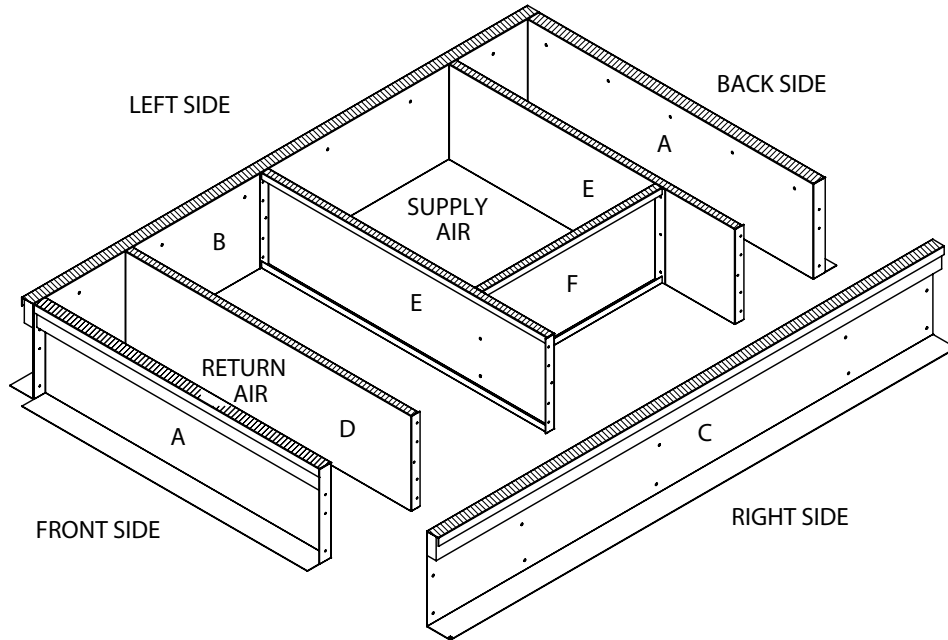

Figure 15: Roof Curb Assembly (DPS 007-015)¹



- NOTE:**
1. Check submittal drawing for gas/water/electrical/supply/return air opening
 2. Horizontal above the roof gas connection only
 3. All dimensions in inches

Standard Roof Curb – Medium Cabinet

Roof Curb for ERW – Medium Cabinet

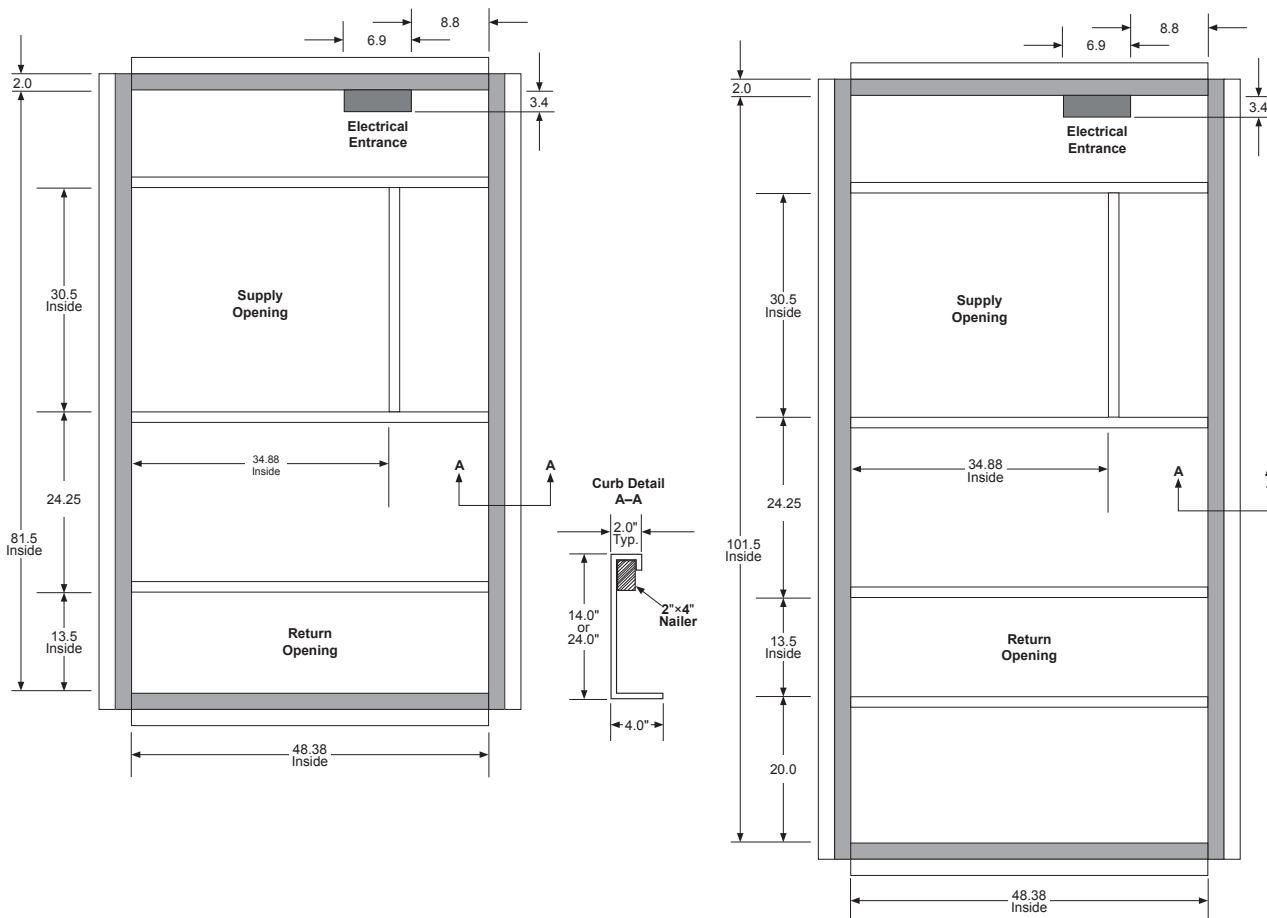
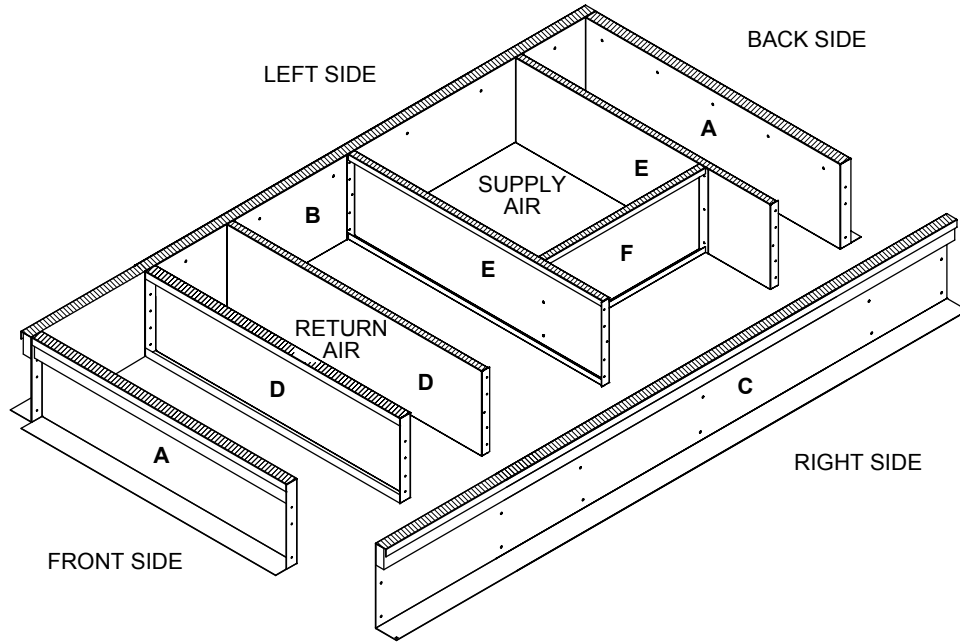
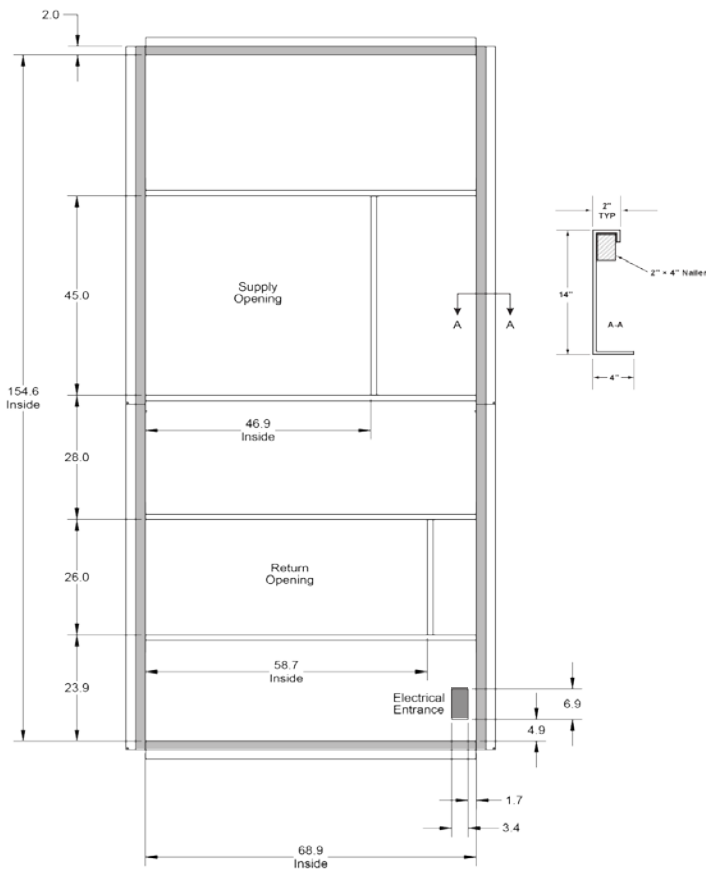

Figure 16: Roof Curb Assembly (DPS 016-028)'



- NOTE:**
1. Check submittal drawing for gas/water/electrical/supply/return air opening
 2. Horizontal above the roof gas connection only
 3. All dimensions in inches

Standard Roof Curb – Large Cabinet



Roof Curb for ERW – Large Cabinet

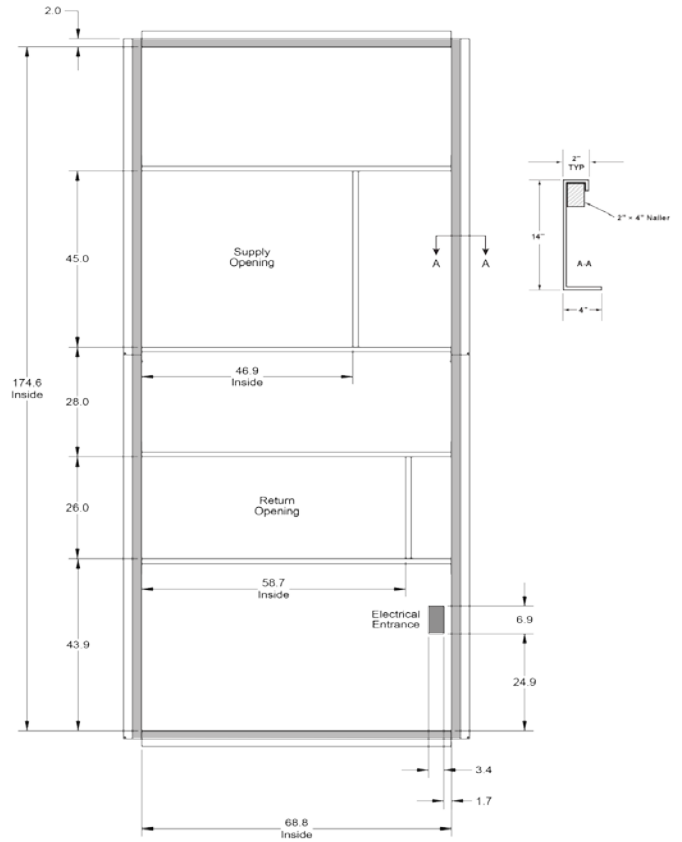

Acoustical Considerations

Good acoustical design is critical for any installation and should start at the earliest stages in the design process. Common sound paths for rooftop equipment must be addressed are:

- Radiated sound through the bottom of the unit (air handling section and condensing section) and into the space
- Radiated sound to the property line
- Structure-borne vibration from the unit to the building
- Airborne sound through the supply air duct
- Airborne sound through the return air duct

Locating rooftop equipment away from sound sensitive areas is critical and the most cost effective means of avoiding sound problems. If possible, rooftop equipment should always be located over less sensitive areas such as corridors, toilet facilities or auxiliary spaces and away from office areas, conference rooms and classrooms. Some basic guidelines for good acoustical performance are:

- Provide proper structural support under all areas of the unit
- Always locate the unit's center of gravity close to a main support to minimize roof deflection
- Use a concrete deck or pad when a unit has to be located over an occupied space where good acoustics are essential
- Only the supply and return air ducts should penetrate the acoustical material and decking within the curb perimeter, and the openings must be sealed once the duct is installed
- Don't overlook the return air path. Never leave a clear "line of sight" into a return or exhaust fan; always include some duct work (acoustically lined tee) at the return inlet
- Place acoustical material in the area directly beneath the condensing section
- Select acoustical material that discourages microbial growth
- Minimize system static pressure losses to reduce fan sound generation
- Design duct systems to minimize turbulence
- Account for low frequency duct breakout in system design. Route the first 20 ft. of rectangular duct over non-sensitive areas and avoid large duct aspect ratios. Consider round or oval duct to reduce breakout

There are many sound sources in rooftop systems. Fans, compressors, condenser fans, duct take-offs, etc., all generate sound. For guidelines on reducing sound generation in the duct system, refer to the ASHRAE Applications Handbook. Contact your local Daikin sales representative for equipment supply, return and radiated sound power data specific to your application.

Ductwork Considerations

A well-designed duct system is required to allow the rooftop equipment to provide rated performance and to minimize system resistance and sound generation. Duct connections to and from units should allow straight, smooth airflow transitions. Avoid any abrupt change in duct size and sharp turns in the fan discharge. Avoid turns opposed to wheel rotation since they generate air turbulence and result in unwanted sound. If 90° turns are necessary, use turning vanes. Refer to the ASHRAE Applications Handbook for specific guidelines relevant to rooftop equipment.

Return Duct

The return path is the most often overlooked. A section of return duct is required to avoid a "line of sight" to the return air opening and to provide attenuation of return air sound. Install an insulated tee with a maximum duct velocity of 1000 to 1200 feet per minute. Extend the duct 15 feet to provide adequate attenuation.

Supply Duct

Insulate supply air ductwork for at least the first 20 feet from the unit. Consider the use of round or oval ductwork, as it significantly reduces low frequency breakout noise near the equipment. If rectangular duct is used, keep the aspect ratio of the duct as low as possible. The large flat surfaces associated with high aspect ratios increase low frequency breakout to the space and can generate noise, such as "oil canning." The maximum recommended supply duct velocity is 1800 to 2000 feet per minute.

Duct High Limit

A Daikin Packaged System with VAV control includes a duct high limit switch as a standard feature that is of particular importance when fast acting, normally-closed boxes are used.

Vibration Isolation

Make duct attachments to the unit with a flexible connection. Economizer and Exhaust Fan Application Rooftop economizer applications usually require exhaust fans to properly control building pressure and maintain minimum ventilation. The air balancer must adjust the outdoor air damper to provide minimum ventilation settings. The EAF is normally-off during non-economizer operation. During these minimum outdoor air conditions, the system essentially acts like a supply fan only system.

Smoke and Fire Protection

Due to the wide variation in building design and ambient operating conditions our units are applied, we do not represent or warrant that our products are fit and sufficient for smoke, fume, and fire control purposes. The owner and a fully qualified building designer are responsible for meeting all local and NFPA building code requirements with respect to smoke, fume, and fire control. The unit's control panel has a terminal block that a supply air and return air smoke detector can be wired to. An optional return air smoke detector is offered. Any other smoke detector, its installation, and the wiring to the unit controller are all field supplied.

Variable Air Volume Application

Rebel units include ECM supply and exhaust fans to provide variable air volume (VAV) control as shown in Figure 17. Daikin Rebel variable air volume systems (VAV) employ the concept of varying the air quantity to a space at a constant temperature, thereby balancing the heat gains or losses and maintaining the desired room temperature. This ability to reduce supply air quantities not only provides substantial fan energy savings at partial load conditions, but it also minimizes equipment sizing. Variable volume systems offer the following advantages:

Figure 17: Variable Air Volume (VAV) Control

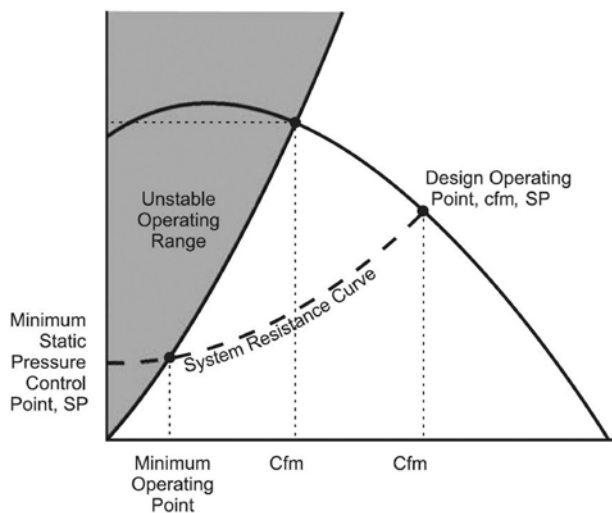

- Lower system first cost by using system diversity to reduce equipment and duct sizes
- Lower operating costs by reducing fan energy demands, especially at part load conditions
- Provides excellent acoustics at lower air flows

In placing a duct static pressure sensor, locate a pressure tap near the end of the main duct trunk. Adjust the static pressure setpoint so that at minimum airflow all of the terminals receive the minimum static pressure required plus any downstream resistance. Locate the static pressure sensor tap in the ductwork in an area free from turbulence effects and at least ten duct diameters downstream and several duct diameters upstream from any major interference, including branch takeoffs.

Single Zone Variable Air Volume Application

A unit configured for single zone VAV will use discharge air control for mechanical cooling and heat, with VAV control of the supply air fan based upon the space or return air temperature. During cooling, the MicroTech III controller increases the ECM fan motor speed when the space temperature rises above the setpoint, and it decreases fan speed when space temperatures approach the setpoint. Mirror-image heating control is also provided. The MicroTech III controller will also use the control temperature to transition between cooling, fan only, and heating modes. Singlezone variable volume systems offer the following advantages:

- Lower system first cost
- Lower operating costs by reducing fan energy demands, especially at part load conditions
- Provides excellent acoustics at lower air flows

Fan Operating Range

The acceptable system operating range of the Daikin rooftop is determined by all of the following characteristics. Each of these limiting factors must be considered for proper performance and component design life:

- Unstable fan operation
- Maximum fan rpm
- Maximum cabinet static pressure
- Maximum face velocity (cooling coil is most important)
- Minimum furnace velocity
- Turndown capability on VAV applications
- Compressor operating pressures

Indoor Fan and Motor Heat

The indoor fan and motor electrical consumption is a sensible cooling load approximately equal to 2.8 MBh per bhp (depending slightly on motor efficiency). The fan and motor temperature rise is equal to $Btuh / (1.08 \times cfm)$ and is typically about 3°F.

Altitude Adjustments

Fan Curve Performance

Fan curve performance is based on 70°F air temperature and sea level elevation. Selections at any other conditions require adjustment for air densities listed in [Table 1 on page 23](#). Higher elevations generally require more rpm to provide a given static pressure but less bhp due to the decrease in air density.

Example:

Assume 2,000 cfm is required at 1.00" TSP. The elevation is 5000 ft. and 70°F average air temperature is selected. A 14" SWSI airfoil fan is selected.

1. The density adjustment factor for 5000 ft. and 70°F is 0.83.
2. TSP must be adjusted as follows:
 $1.0" / 0.83 = 1.20"$.
3. Locate 2,000 cfm and 1.2 on the fan curve.
Rpm = 1720 and bhp = 0.53.
4. Consumed fan power at design =
 $0.53 \text{ bhp} \times 0.83 = 0.44 \text{ bhp}$.

Table 1: Temperature and Altitude Conversion Factors

Air temp (°F)	Altitude (feet)								
	0	1000	2000	3000	4000	5000	6000	7000	8000
-20	1.20	1.16	1.12	1.08	1.04	1.00	0.97	0.93	0.89
0	1.15	1.10	1.08	1.02	0.99	0.95	0.92	0.88	0.85
20	1.11	1.06	1.02	0.98	0.95	0.92	0.88	0.85	0.82
40	1.06	1.02	0.98	0.94	0.91	0.88	0.84	0.81	0.78
60	1.02	0.98	0.94	0.91	0.88	0.85	0.81	0.79	0.76
70	1.00	0.96	0.93	0.89	0.86	0.83	0.80	0.77	0.74
80	0.98	0.94	0.91	0.88	0.84	0.81	0.78	0.75	0.72
100	0.94	0.91	0.88	0.84	0.81	0.78	0.75	0.72	0.70
120	0.92	0.88	0.85	0.81	0.78	0.76	0.72	0.70	0.67
140	0.89	0.85	0.82	0.79	0.76	0.73	0.70	0.78	0.65

Condenser Performance

Altitudes greater than sea level require a derate in condenser and cooling performance that can be estimated as follows:

For altitudes up to 6000 feet:

- Cooling capacity decrease factor (all sizes) = 0.5% per 1000 feet
- Compressor kW increase factor = 0.6% per 1000 feet

For altitudes above 6000 feet, consult the factory. The actual derate varies with each individual unit and design conditions. Your local Daikin representative can provide exact performance data.

Furnace Performance

Gas heat performance data is based on standard 70°F air temperature and zero feet altitude (sea level).

For altitudes between 2000 to 6000 feet, the gas burner must be derated 4% for every 1000 feet of altitude.

Example:

A 400 MBh furnace at an altitude of 3000 feet is derated ($0.04 \times 3 = 0.12$). At 400 MBh input ($400 \times 0.12 \text{ MBh}$), the actual input is ($400 - 48 = 352 \text{ MBh}$) at 3000 feet.

For altitudes above 6000 feet, consult the factory.

System Operating Limits

Daikin DPS systems are designed to operate over an extensive operating range. However, for proper system operation some limits do apply.

To help prevent moisture blow-off, design guidelines have been established for cooling coil selection. For applications outside of these limits, consult your Daikin sales representative.

In addition to maximum face velocity limitations, minimum velocity guidelines must also be followed. In order to maintain proper refrigeration performance, the minimum coil face velocity is 175 ft./min. When selecting a variable air volume unit, it is necessary to design the system such that the 175 ft./min. limit is maintained at light load conditions.

Condensate Drainage

Provide all drain pans with a properly sized p-trap to allow free drainage of coil condensate. For trap sizing, follow instruction given in IM 842. Run all traps and drain lines full size from the threaded unit connection to the roof drain.

Zone Sensor Placement

Placement of the zone temperature sensor is critical for proper and economical operation of the heating and cooling system. It is generally recommended that the space sensor be located on an inside wall (3 to 5 feet from an outside wall) in a space having a floor area of at least 400 square feet. Do not locate the sensor below the outlet of a supply diffuser, in the direct rays of the sun, on a wall adjacent to an unheated or abnormally warm room (boiler or incinerator room), or near any heat producing equipment. Where zone sensor placement is a problem, all zone control systems, as standard, have the capability to use a return air sensor for heating and cooling.

Unit Wiring

All units require three phase, 60 Hz, 208, 230, 460, or 575 volt power supply. All units include branch circuits and short circuit protection and are available with a power block or nonfused disconnect switch. Each unit is provided with a 115 V convenience outlet. Per the NEC, this circuit must be fed independent of the main unit power supply.

All wiring must be installed in accordance with the National Electric Code (NEC) and local codes.

Winter Shipment

Flat bed shipment in winter can expose units to harsh road chemicals. Since equipment size and configuration precludes covering during transit, wash units free of these chemicals as soon as possible to help prevent corrosion.

Coil Freeze Protection

When applying roof-mounted equipment in areas that experience subfreezing conditions, coil freeze protection measures must be provided. Subfreezing temperatures can adversely affect water and steam coils during controlled or uncontrolled unit shutdowns and even during unit operation. Daikin economizer dampers are arranged to direct the outside and return air streams toward each other, however, there may not always be a uniform unit temperature profile under all load and ambient temperatures. Some temperature stratification will occur, particularly at low ambient temperatures and the associated reduced airflow inherent with VAV systems.

Glycol is strongly recommended as a positive means of freeze protection for water coils. No control sequence can prevent coil freezing in the event of a power failure or equipment malfunction. During those periods, glycol is the only positive means of freeze protection. When selecting water coils, specify glycol to account for performance differences.

Parallel Air Paths on Energy Recovery Wheel Applications

Economizer Units

There are three sets or parallel air flow paths on economizer units:

Set 1: OA and RA paths to the SAF

- The OA path APD is normally greater than the RA path APD. Therefore, the air balancer must adjust the RA dampers to not open fully so that sufficient OA is achieved
- The RA path includes return duct ESP. Normally, the SAF handles both of these paths. Therefore, the EAF need not handle the return duct ESP. However:
 - The RA path is not open during economizer operation, so the EAF must handle return duct ESP during economizer operation or excessive positive building pressure will occur
- For VAV units, note that RA cfm during economizer operation normally is less than design return cfm
- An energy analysis must be careful not to overwhelm the EAF with return duct ESP except during economizer cooling

Set 2: OA wheel and OA bypass path to the SAF

Set 3: EA wheel and bypass path to the EAF

100% Outdoor Air Units

There are no parallel flow paths in a 100% OA unit. Instead, there is one counter-flow path (OA and EA paths throughout the wheel). The EAF must be sized for design return duct cfm and ESP as well as the wheel and wheel prefilter pressure drop.

Figure 18: Energy Wheel Parallel Air Path

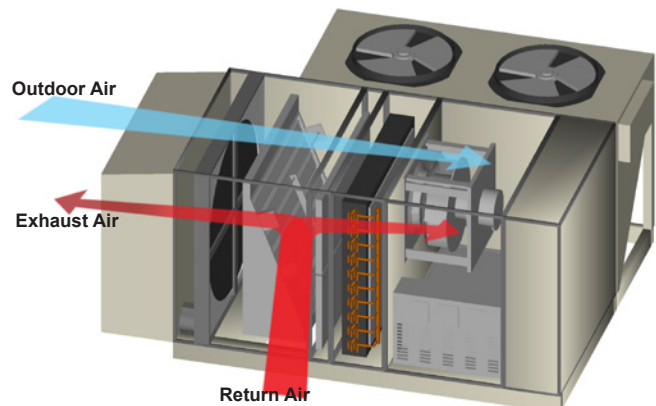

Table 2: Physical Data—Standard Units DPS 003 through 028

Model	Small Cabinet				Medium Cabinet				Large Cabinet					
	003	004	005	006	007	010	012	015	016	018	020	025	028	
Cooling only performance														
Gross Cooling capacity (tons)	3	4	5	6	7.5	10	12	15	15.5	17.5	20.1	25	27.5	
Nominal airflow (cfm)	1125	1500	1875	2100	2450	3500	4200	5250	5900	6600	7600	9500	10400	
EER ¹	13.5	12.4	13.0	11.6	12.6	12.5	12.1	11.0	Consult Factory				11.3	10.1
IEER ¹ or SEER	16.9	17.0	18.5	19.8	20.6	19.4	18.5	18.0					18.3	17.7
Heat pump performance⁴														
High Temperature Capacity @ 47°F (MBh)	32	43	54	64	78	105	134	164	—	—	—	—	—	
COP @ 47°F or HSPF ⁵	9.2	8.9	8.5	3.69	3.66	3.42	3.33	3.64	—	—	—	—	—	
Low Temperature Capacity @ 17°F (MBh)	20	24	33	39	47	61.5	77	91	—	—	—	—	—	
COP @ 17°F ⁵	N/A	N/A	N/A	2.54	2.42	2.38	2.32	2.25	—	—	—	—	—	
Electric heat performance														
Control Options	2/4/SCR				4 stage/SCR				4 stage/ SCR					
KW (low/medium/high heat)	6/12/18/30				18/36/54/72				30, 45, 60, 90, 120, 150					
Gas heating performance														
Input capacity (MBh)	80/120/160				200/300/400				300, 450, 600					
Number of stages (staged option)	2				2				2 or 4 on 450 and 600					
Turndown (Modulating options)	5:1				5:1, 10:1				5:1 on 300 or 12:1					
Gas connection size (mpt)	1/2"				3/4"				3/4"					
Steady state efficiency	80%				80%				80%					
Heating coil														
Type	Hot Water				Hot Water				Hot Water					
Rows / FPI (high heat/low heat)	(2/10) / (1/8)				(2/10) / (1/8)				1/12, 2/12, 3/13					
Face area (sq ft)	2.5				5.4				12.3					
Compressors														
Quantity / Type	(1) Inverter Scroll				(1) Inverter Scroll, (1) Fixed Speed Scroll				1 Inverter Scroll on 16–20, 1 Inverter Scroll + 1 fixed speed scroll					
Number of stages	Modulating				Modulating				Modulating					
Refrigerant	R-410A				R-410A				R - 410A					
Indoor coil														
Rows / FPI	3/16	4/16	4/14	4/14	3/15	4/15	4/15	6/12	3/15	3/15	4/15	4/15	4/15	
Face area (sq ft)	4.8	4.8	6.0	6.0	14.0	15.4	15.4	15.4	22.0	22.0	21.6	21.6	21.6	
Capacity control	Electronic Expansion Valve (EEV)				Electronic Expansion Valve (EEV)				Electronic Expansion Valve (EEV)					
Outdoor coil														
Type: non-heat pump/heat pump ⁶	Aluminum Micro-channel/Copper tube-Aluminum fin								Aluminum Micro-channel					
Rows / FPI — heat pump	2/16	2/16	3/16	3/16	3/16	4/16	4/16	4/16	—	—	—	—	—	
Rows / FPI — non-heat pump	1/21	1/21	3/16	3/16	1/21	1/21	4/16	1/21	1/23					
Outdoor fan and motor														
HP / Quantity	0.5/1	0.5/1	1.0/1	1.0/1	1.0/2	1.0/2	1.0/2	1.0/2	3.5/1					
Fan Diameter (in) / Quantity	27/1	27/1	27/1	27/1	27/2	27/2	27/2	27/2	39/1					
Indoor fan														
Type	Centrifugal Airfoil (SWSI)				Centrifugal Airfoil (SWSI)				Centrifugal Airfoil (SWSI)					
Quantity / Diameter ²	(1) 12", (1) 14", (1) 16"				(1) 14", (1) 16", (1) 22"	(1) 22"			1/16 or 1/20	1/20 or 1/24		1/24		
Quantity / Diameter ³	(1) 12", (1) 14", (1) 16"				(1) 14", (1) 16", (1) 22"				1/16 or 1/20					
Drive type	Direct Drive				Direct Drive				Direct Drive					
Motor HP range	1.3 / 2.3 / 4.0				4.0 / 8.0				1 - 7.5	2 - 10	3 - 15	3 - 20		
Hot gas reheat coil														
Coil Type	Microchannel				Microchannel				Microchannel					
Control Type	Modulating				Modulating				Modulating					
Temperature rise	20°				20°				20°					
Filters														
Type	2", 4"				2", 4"				2" (MERV8), 4" (MERV14)					
Area (sq ft)	7.1				18				27.0					
Qty. - size	4 - 16 × 16				6 - 18 × 24				9 - 18 × 24					

NOTE:

1. EER and IEER/SEER for Cooling Only VAV, 460 volt unit
2. Mixed Outside Air and Return Air units
3. 100% Outside Air unit only
4. Heat pump performance for units with back up electric heat
5. HSPF for 3-5 ton units only
6. Size 5, 6 and 12 non-heat pump models use copper tube aluminum fin

Table 3: Physical Data—Unit Weights DPS 003 through 028

Model	Small Cabinet				Medium Cabinet			
	003	004	005	006	007	010	012	015
Weight (lbs.)								
Base Weight ¹	1000	1000	1025	1058	1600	1600	1600	1763
Heat pump	1030	1030	1058	1058	1660	1660	1660	1823
Electric Heat	45	45	45	45	100	100	100	100
Hot Water 1 Row	11	11	11	16.5	30	30	30	30
Hot Water 2 Row	32	32	32	20	31	31	31	31
Gas Heat	75	75	63	93	186	186	186	186
Hot Gas Re-heat	8	8	12	12	28	31	31	31
Economizer	163	163	163	163	308	308	308	308
High capacity coil	105	105	105	105	215	215	215	215
Energy Wheel Weight Adds (lbs.)								
100% OA	160	160	160	160	300	300	300	300
Mixed Air	175	175	175	175	250	250	250	250

1. Includes standard cooling coil

Model	Large Cabinet				
	016	018	020	025	028
Base Weight (in lbs.)	2,465		2,575	2,700	
Heat Pump	—	—	—	—	—
Electric Heat	228				
Hot Water Heat	1-row	60			
	2-row	100			
	3-row	140			
Gas Heat	300	175			
	450	225			
	600	275			
Hot Gas Reheat	30				
Economizer	500				
ERW – Small	350				
ERW – Large	400				
Indoor Fan	16"	100			
	20"	150			
	24"	260			
Indoor Fan Motors	1	36			
	1.5	41			
	2	40			
	3	69			
	5	84			
	7.5	115			
	10	128			
	15	211			
20	225				
Exhaust Fan	250				

Size 3–15 Fan Weights (lbs.)	
12 Inch (310 mm)	87
14 Inch (360 mm)	91
16 Inch (400 mm)	115
22 Inch (560 mm)	115

Curb Weights (lbs.)	14"	24"
003—006	156	230
007—015	200	295
016—028	566	657

Table 4: Refrigerant Charge

Unit Size	Cooling Model		Heat Pump Model	
	Standard Unit	Standard Unit w/ MHGRH	Standard Unit	Standard Unit w/ MHGRH
3	6.6	11.3	12.0	14.4
4	6.5	11.3	12.6	15.0
5	15.3	18.2	16.8	19.7
6	15.3	18.2	16.8	19.7
7.5	11.1	17.8	26.0	31.2
10	20.0	25.8	40.0	45.8
12	20.0	25.8	40.0	45.8
15	24.4	30.2	46.0	51.8
16	37.0	Consult Factory		
18	37.0			
20	37.0			
25	35.5			
28	35.5			

Fan Curves

Figure 19: Fan Curve – 12 inch Fan

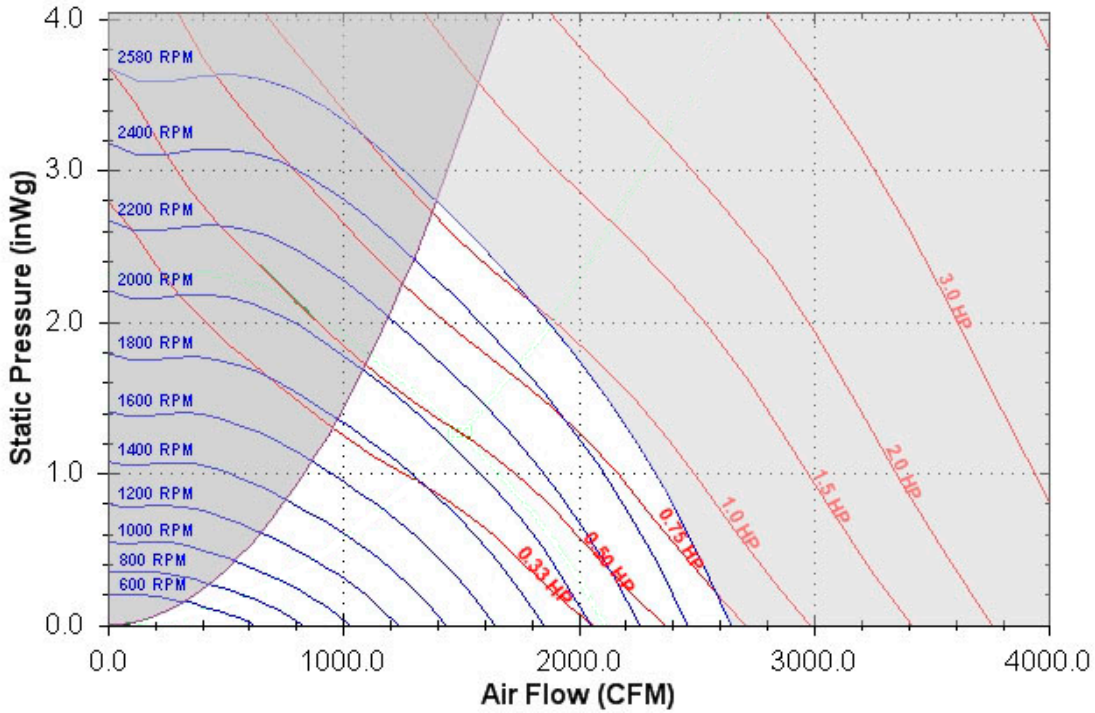

Figure 20: Fan Curve – 14 inch Fan

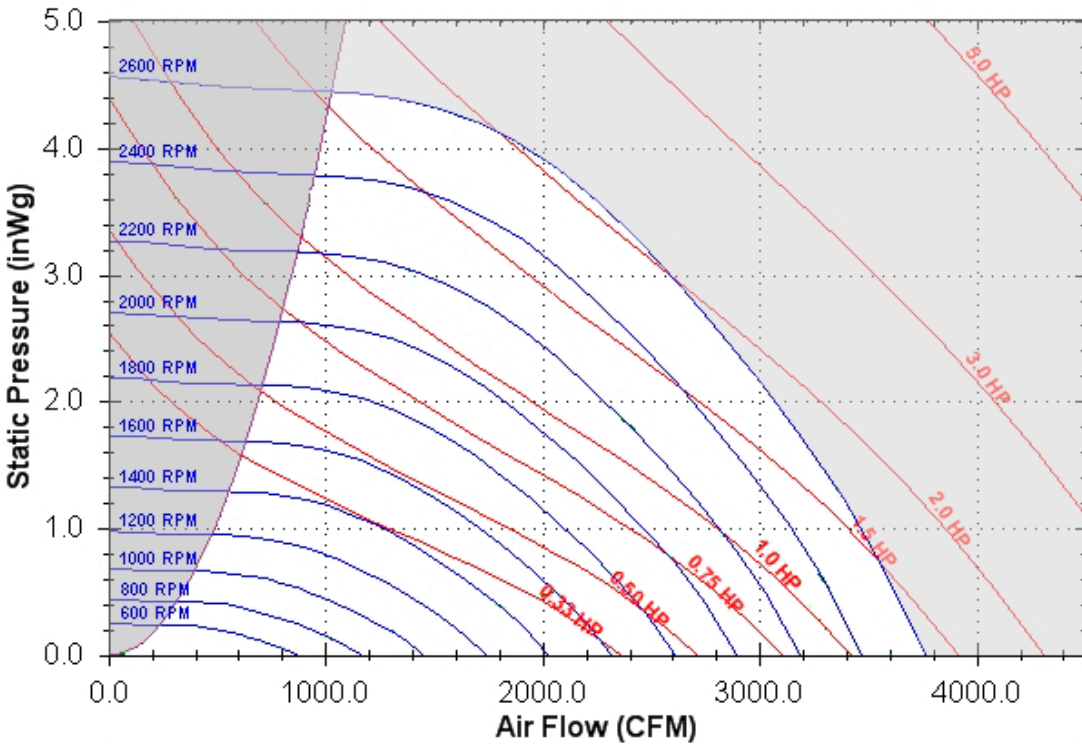

Figure 21: Fan Curve – 16 inch Fan

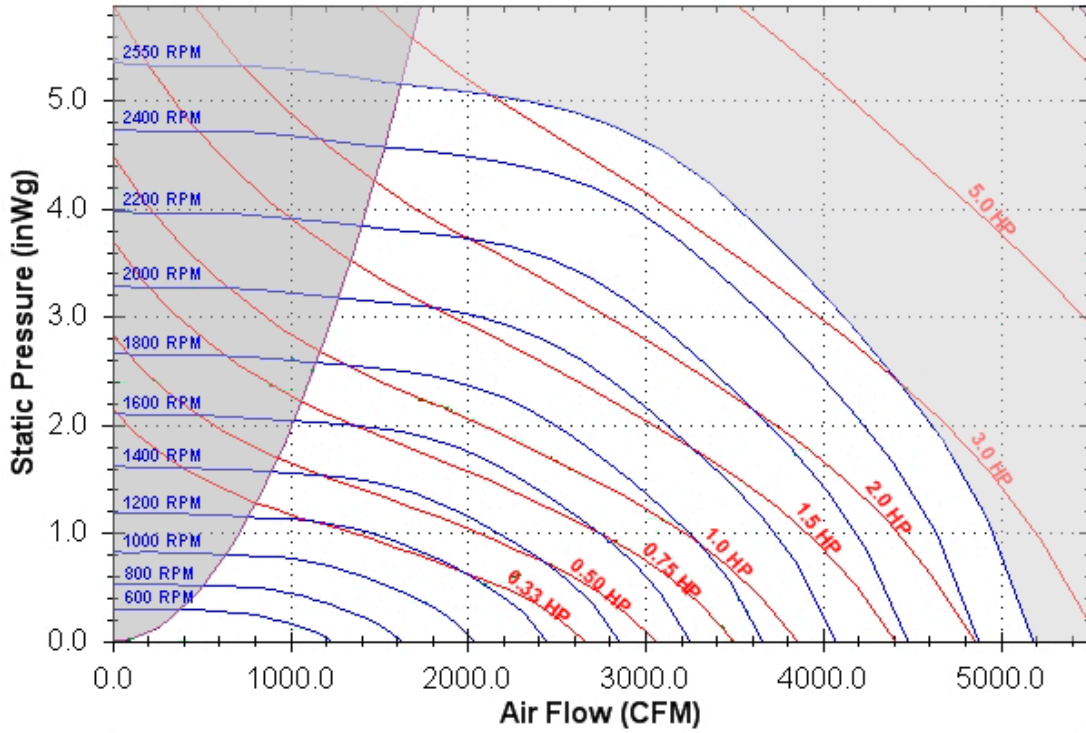

Figure 22: Fan Curve – 22 inch Fan

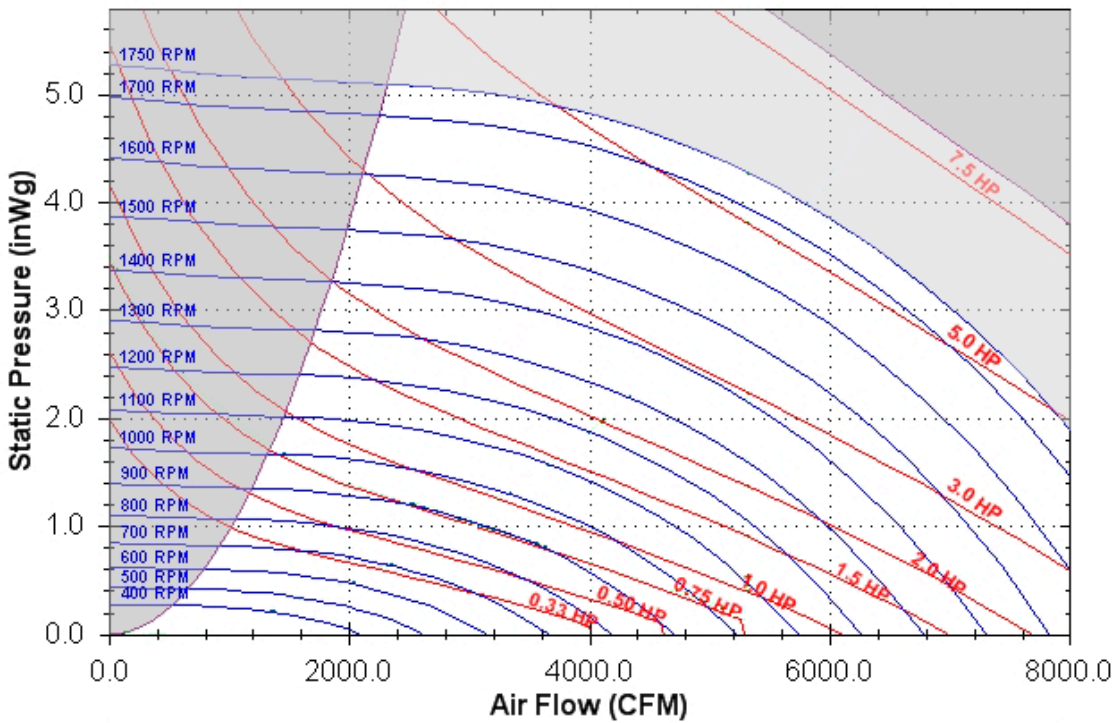

Figure 23: Fan Curve – DDPL-16 – Size 16–28

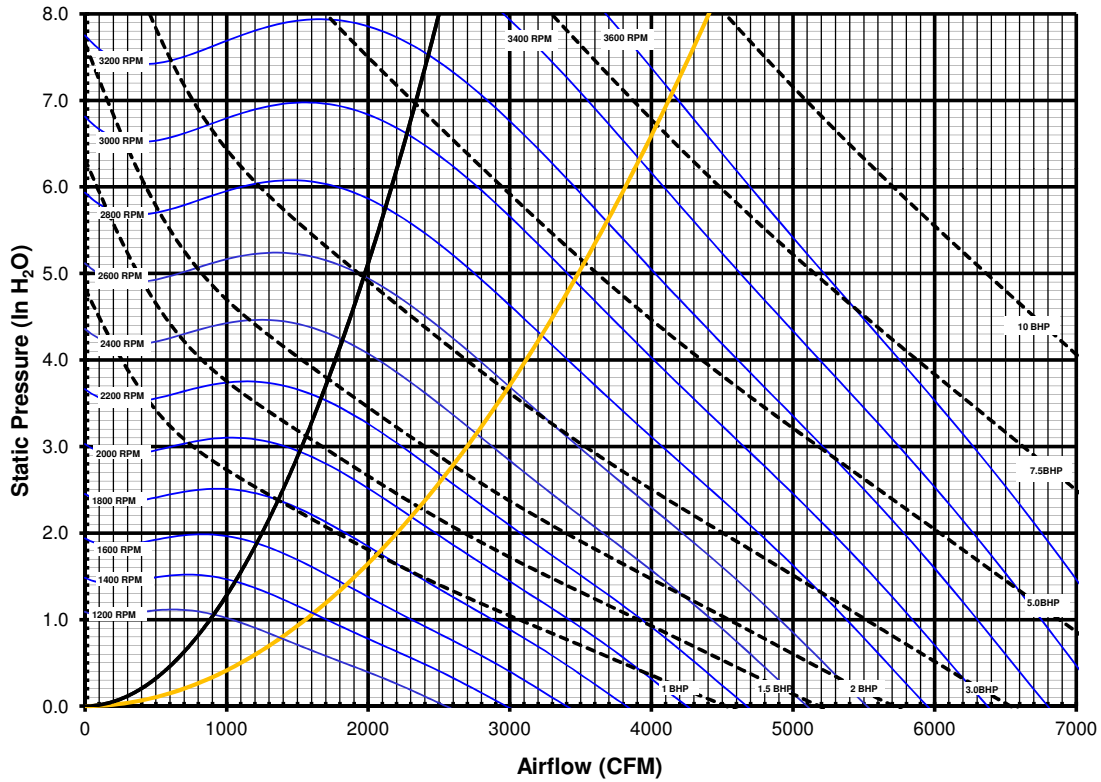

Figure 24: Fan Curve – DDPL-20 – Size 16–28

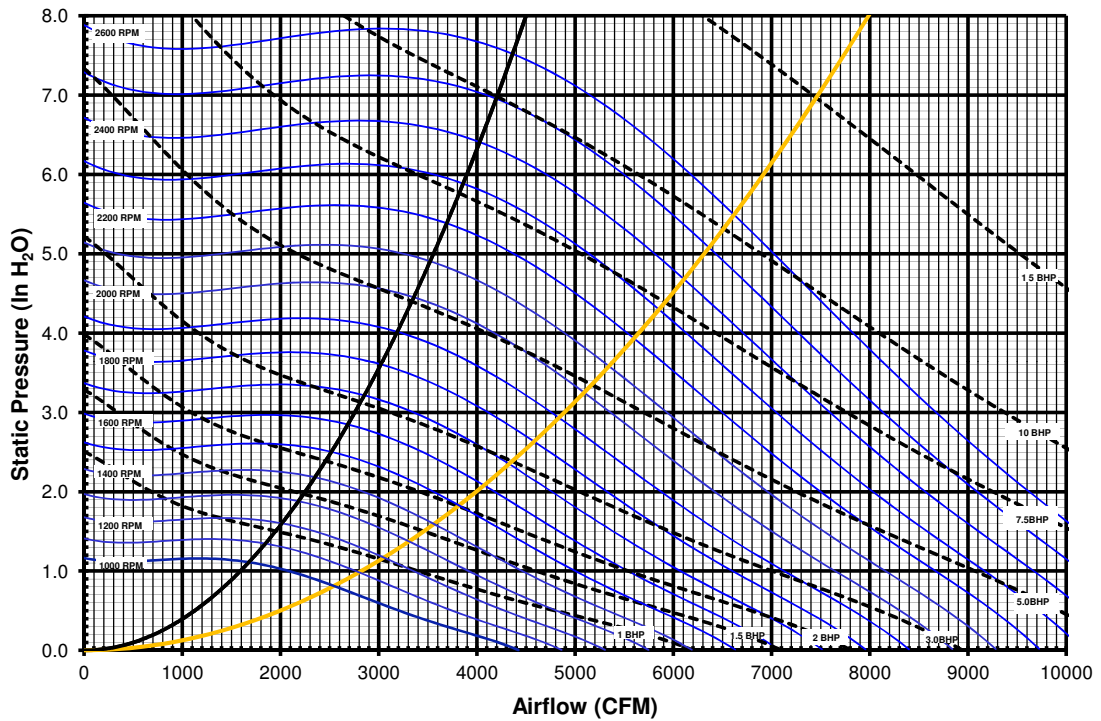
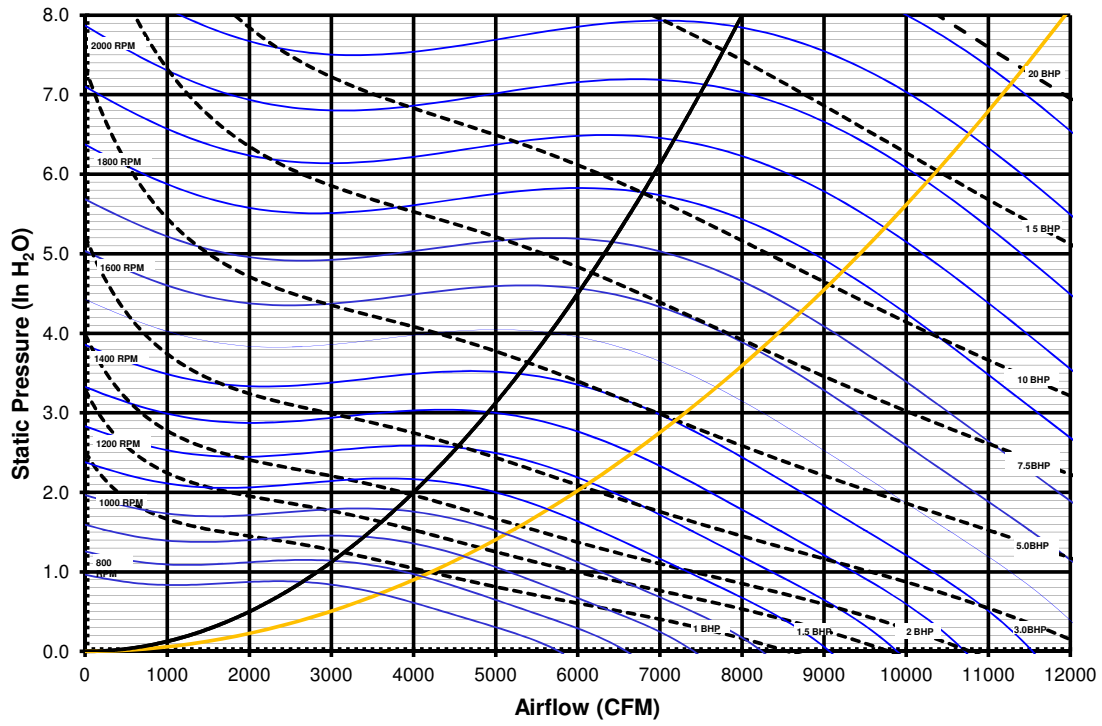

Figure 25: Fan Curve – DDPL-24 – Size 16–28



Heating Capacity

Table 5: Heating Capacity – Electric Heaters

Unit	Stages	Option # 1				Option # 2				Option # 3				Option # 4				Option # 5				Option # 6																					
		KW	MBH	Delta T ¹	Min (cfm)	KW	MBH	Delta T ¹	Min (cfm)	KW	MBH	Delta T ¹	Min (cfm)	KW	MBH	Delta T ¹	Min (cfm)	KW	MBH	Delta T ¹	Min (cfm)	KW	MBH	Delta T ¹	Min (cfm)	KW	MBH	Delta T ¹	Min (cfm)														
003	2, SCR	6	20.5	15.8	316	12	40.9	31.6	632	18	61.4	47.4	948	30	102.4	60.0 ³	1580	—	—	—	—	—	—	—	—	—	—	—	—	—													
004				11.9				23.7				35.6				59.3		—	—	—	—	—	—	—	—	—	—	—	—	—	—	—	—	—	—	—	—	—	—	—	—		
005				9.5				19.0				28.4				47.4		—	—	—	—	—	—	—	—	—	—	—	—	—	—	—	—	—	—	—	—	—	—	—	—	—	
006				7.9				15.8				23.7				39.5		—	—	—	—	—	—	—	—	—	—	—	—	—	—	—	—	—	—	—	—	—	—	—	—	—	
007	4, SCR	18	61.4	19.0	948	36	122.9	37.9	1896	54	184.3	56.9	2844	72.0 ²	245.8	60.0 ³	3793	—	—	—	—	—	—	—	—	—	—	—	—	—													
010				14.2				28.4				42.7				56.9		—	—	—	—	—	—	—	—	—	—	—	—	—	—	—	—	—	—	—	—	—	—	—	—	—	
012				11.9				23.7				35.6				47.4		—	—	—	—	—	—	—	—	—	—	—	—	—	—	—	—	—	—	—	—	—	—	—	—	—	—
015				9.5				19.0				28.4				37.9		—	—	—	—	—	—	—	—	—	—	—	—	—	—	—	—	—	—	—	—	—	—	—	—	—	—
016				7.9				15.8				23.7				39.5		—	—	—	—	—	—	—	—	—	—	—	—	—	—	—	—	—	—	—	—	—	—	—	—	—	—
018	30	102	1580	17.5	45	154	26.2	2369	60	205	34.9	3159	90	307	52.4	4739	—	—	—	—	—	—	—	—	—	—	—	—	—														
020				13.5			20.3				27.1				34.9		—	—	—	—	—	—	—	—	—	—	—	—	—	—	—	—	—	—	—	—	—	—	—	—			
025				10.8			16.2				21.7				27.1		—	—	—	—	—	—	—	—	—	—	—	—	—	—	—	—	—	—	—	—	—	—	—	—	—	—	
028				9.8			14.8				19.7				26.2		—	—	—	—	—	—	—	—	—	—	—	—	—	—	—	—	—	—	—	—	—	—	—	—	—		
				13.5			20.3		60		205	27.1		90	307	40.6		120	409	54.2		6319	—	—	—	—	—	—	—														
				10.8			16.2		60		205	21.7		90	307	32.5		120	409	43.3		6319	150	512	54.2		7898	49.2															
				9.8			14.8		60		205	19.7		90	307	29.5		120	409	39.4		6319	150	512	49.2		7898	49.2															

- 1. Temperature is calculated at nominal air flow
- 2. Not available in 208 & 230 Volt
- 3. 60 degree max rise

Table 6: Heating Capacity and Water Pressure Drop – Hot Water Coils

Unit	MBH	GPM	WPD	Connection Size
3	61.4	6.1	1.0	1.375 Sweat
4	72.9	7.3	1.4	1.375 Sweat
5	82.6	8.2	1.7	1.375 Sweat
6	91.6	9.2	2.2	1.375 Sweat
7.5	149.7	15.0	3.1	1.375 Sweat
10	176.9	17.8	4.2	1.375 Sweat
12	195.9	19.6	5.1	1.375 Sweat
15	221.4	22.1	6.4	1.375 Sweat
16	347	35.5	0.7	1.375 Sweat
18	376	38.4	1.2	1.375 Sweat
20	403	41.1	1.3	1.375 Sweat
25	464	47.3	1.4	1.375 Sweat
28	497	50.7	1.6	1.375 Sweat

Nominal airflow, 60°EAT, approximately 180°–160° water. WPD does not include a field supplied valve pressure drop. 2-row performance shown, 1-row coil also available.

Table 7: Heating Capacity – Gas Furnaces

Data	Unit Size									
	003–006			007–015			016–028			
	Low Heat	Med Heat	High Heat	Low Heat	Med Heat	High Heat	Low Heat	Med Heat	High Heat	
Heating Input	50	100	150	200	300	400	300	450	600	
Heating Output	40	80	120	160	240	320	240	360	480	
Steady State Efficiency	80%									
Number of Stages	2						2	4		
Turndown ¹	5:1			5:1 or 10:1			5:1	12:1		

- 1. Modulating Heat Only

Air Pressure Drops

Table 8: Pressure Drop – Electric Heaters

Unit	Unit Airflow					
	1000	2000	3000	4000	5000	6000
003–006	0.11	0.36	0.77	—	—	—
007–015	0.02	0.07	0.14	0.23	0.34	0.48

Table 9: Pressure Drop – Hot Water Coils

Unit	Heat Type	Unit Airflow							
		1000	2000	3000	4000	5000	6000	8000	10000
003–006	Low (1 Row)	0.04	0.15	0.32	—	—	—	—	—
	High (2 Row)	0.11	0.37	0.83	—	—	—	—	—
007–015	Low (1 Row)	—	0.05	0.10	0.17	0.26	0.37	—	—
	High (2 Row)	—	0.11	0.23	0.39	0.59	0.83	—	—
016–028	Low (1 Row)	—	—	—	0.09	—	0.17	0.27	0.42
	Medium (2 Row)	—	—	—	0.16	—	0.31	0.51	0.74
	High (3 Row)	—	—	—	0.25	—	0.50	0.80	1.16

Table 10: Pressure Drop – Gas Furnaces

Unit	Heat Type	Unit Airflow							
		1000	2000	3000	4000	5000	6000	8000	10000
003–006	Low (50 MBH)	0.08	0.33	0.74	—	—	—	—	—
	Medium (100 MBH)								
	High (150 MBH)								
007–015	Low (200 MBH)	0.02	0.07	0.14	0.23	0.35	0.49	—	—
	Medium (300 MBH)								
	High (400 MBH)								
016–028	600 MBH	—	—	—	0.10	—	0.23	0.42	0.65

Table 11: Pressure Drop – Components

Component	Unit	Unit Airflow							
		1000	2000	3000	4000	5000	6000	8000	10000
Economizer									
	003-006	0.01	0.05	0.11	—	—	—	—	—
	007-015	0.01	0.03	0.08	0.13	0.20	0.29	—	—
	016-028	—	0.02	—	0.08	—	0.18	0.31	0.49
Filter									
	003-006	0.03	0.12	0.28	—	—	—	—	—
	007-015	0.01	0.02	0.06	0.09	0.15	0.22	—	—
2" MERV 8 (27 ft ²)	016-028	—	0.02	—	0.05	—	0.09	0.13	0.18
4" MERV 14 (27 ft ²)		—	0.05	—	0.11	—	0.19	0.27	0.38
Standard Cooling Coil									
	003-006	0.18	0.46	0.79	—	—	—	—	—
	007	0.03	0.09	0.14	0.20	0.25	0.33	—	—
	010-015	0.04	0.10	0.18	0.26	0.34	0.43	—	—
Hot Gas Reheat									
	003-006	0.03	0.07	0.13	—	—	—	—	—
	007-010	—	0.02	0.04	0.06	0.08	0.11	—	—
	015	—	0.02	0.03	0.05	0.07	0.09	—	—
	016-028	—	0.01	—	0.17	0.22	0.29	0.41	0.58

Table 12: Pressure Drop — Energy Recovery Wheel

	Airflow (CFM)														
	500	750	1000	1250	1500	2000	2500	2800	3000	3500	4000	4500	5000	5500	6500
3 – 6 Tons															
Low Airflow Wheel and Prefilters	0.40	0.58	0.77	0.96	1.12	—	—	—	—	—	—	—	—	—	—
7.5 – 15 Tons															
Low Airflow Wheel and Prefilters	—	—	0.51	—	0.75	0.99	1.22	1.35	—	—	—	—	—	—	—
High Airflow Wheel and Prefilters	—	—	N/A	—	0.38	0.49	0.61	0.68	0.73	0.84	0.96	1.08	1.19	—	—
16 – 28 Tons															
Small Wheel	—	—	—	—	0.52	—	0.88	—	—	1.26	—	—	—	—	—
Large Wheel	—	—	—	—	0.30	—	0.50	—	—	0.71	—	0.92	—	1.14	1.35

Figure 26: DPS 003-006, No Energy Recovery, 0-30% or 100% Outdoor Air

Detail: A-B for Horizontal Supply and Return Air Openings

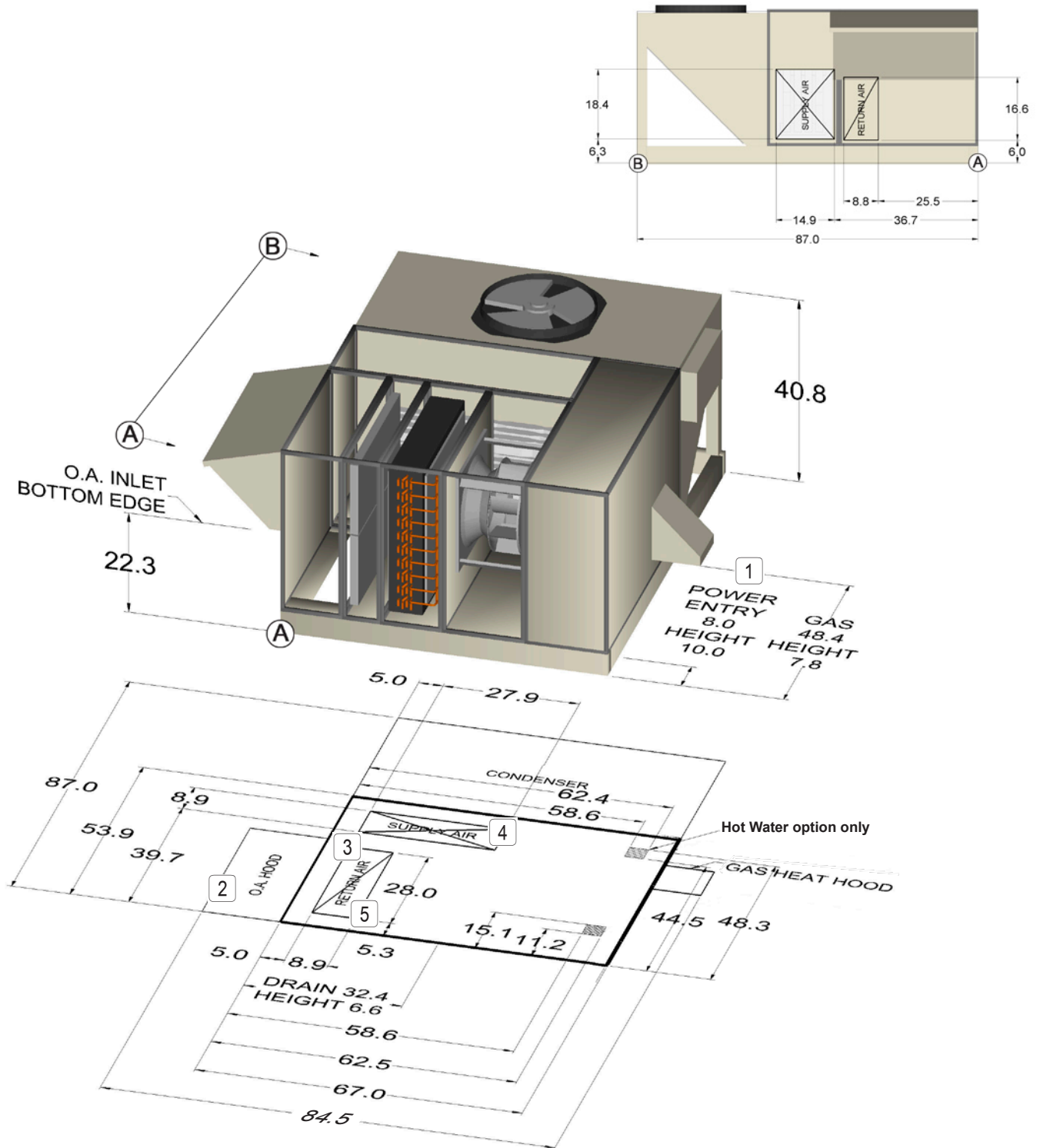

- NOTE:** Horizontal above the roof gas connection only
1. Recommended location for field cut side power connection
 2. Not provided on 100% Return Air units
 3. Not provided on 100% Outdoor Air units
 4. Not provided on units with Horizontal Supply Air opening
 5. Not provided on units with Horizontal Return Air opening

Figure 27: DPS 003–006, Economizer, No Energy Recovery

Detail: A-B for Horizontal Supply and Return Air Openings

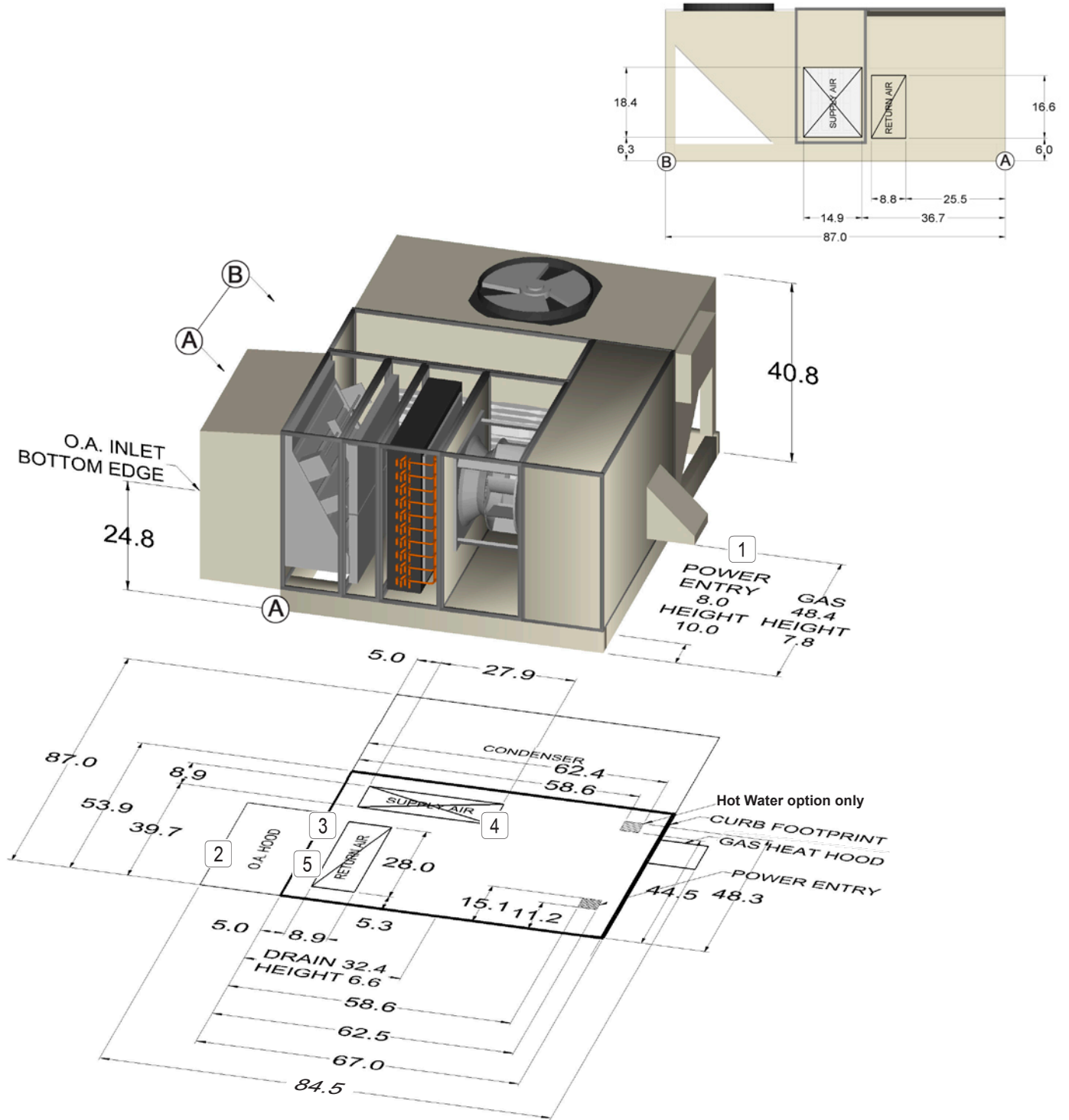

- NOTE:** Horizontal above the roof gas connection only
1. Recommended location for field cut side power connection
 2. Not provided on 100% Return Air units
 3. Not provided on 100% Outdoor Air units
 4. Not provided on units with Horizontal Supply Air opening
 5. Not provided on units with Horizontal Return Air opening

Figure 28: DPS 003–006, Energy Recovery, All Outdoor Air Options

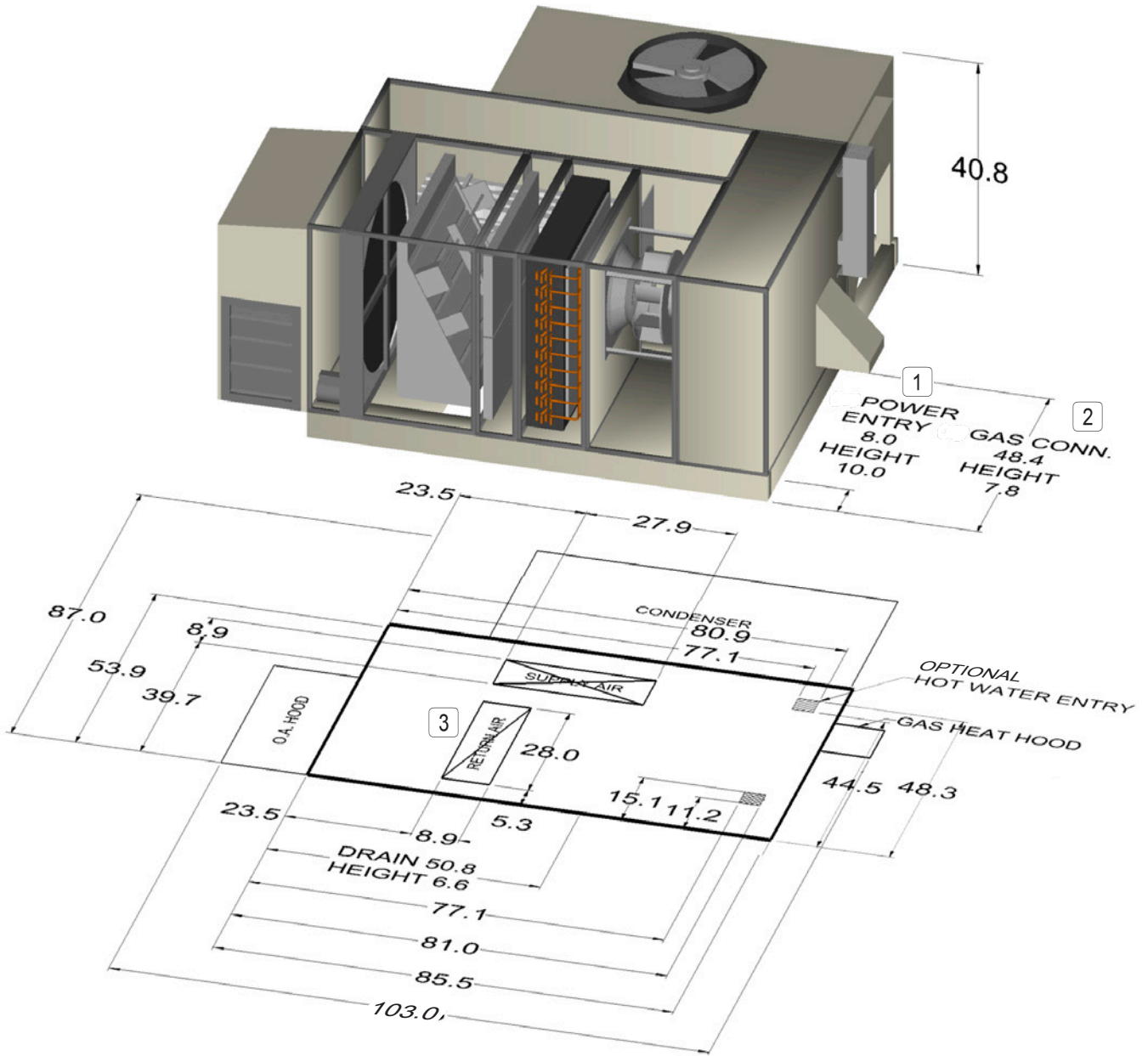

NOTE: 1. Recommended location for field cut side power connection
 2. Horizontal gas connection only. Gas pipe routing within roof curb is not available
 3. Not supplied on 100% OA units

Figure 29: DPS 007–015, Energy Recovery, All Outdoor Air Options

Size (tons)	L
7–12	132.7
15	149.7

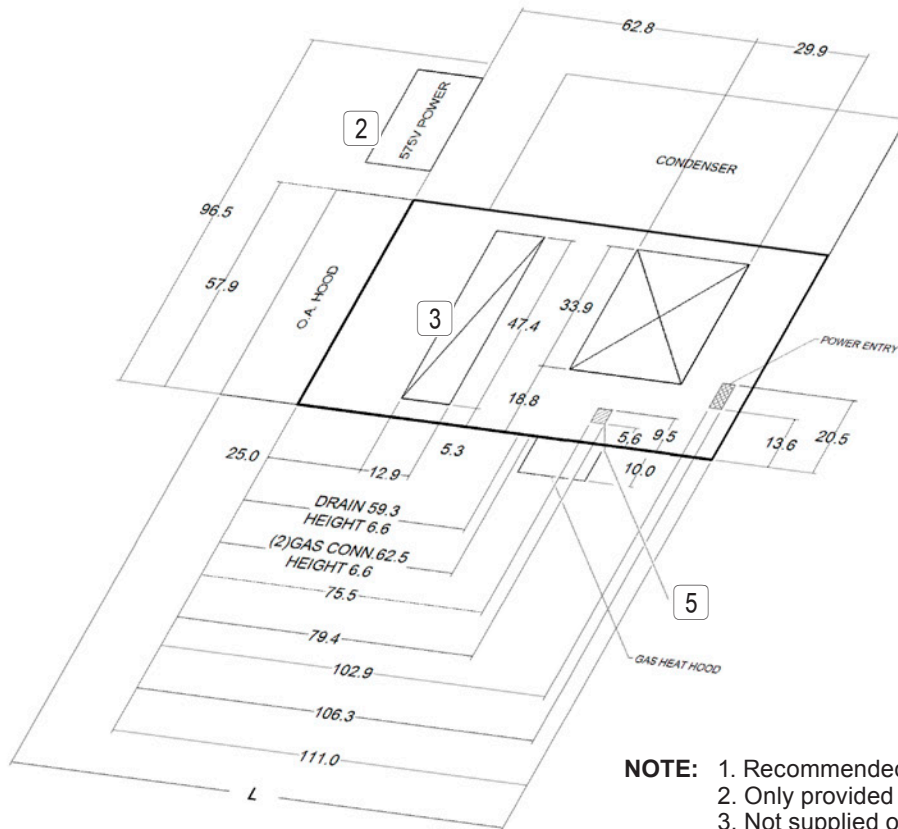
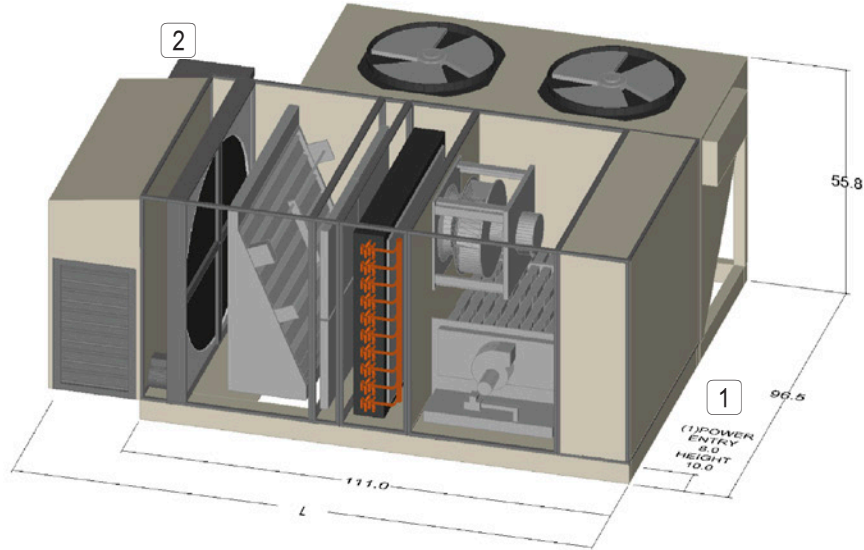

- NOTE:**
1. Recommended location for field-cut, side power opening
 2. Only provided on 575 volt units
 3. Not supplied on horizontal return or 100% OA units
 4. Horizontal, above the roof, gas connection only
 5. Optional field-cut hot water piping entrance

Figure 30: DPS 007-015, Economizer, No Energy Recovery

Size (tons)	L
7-12	112.7
15	129.7

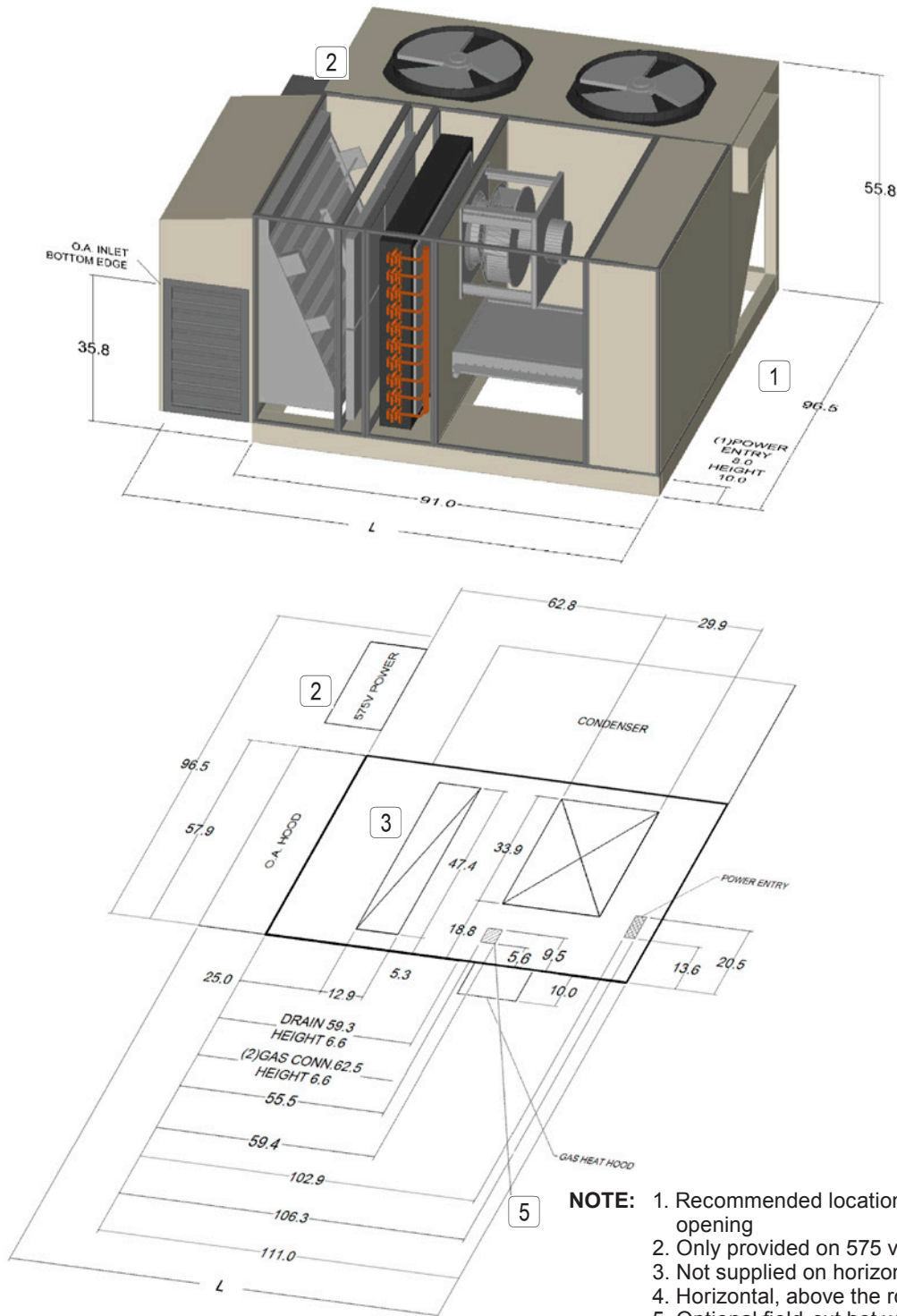
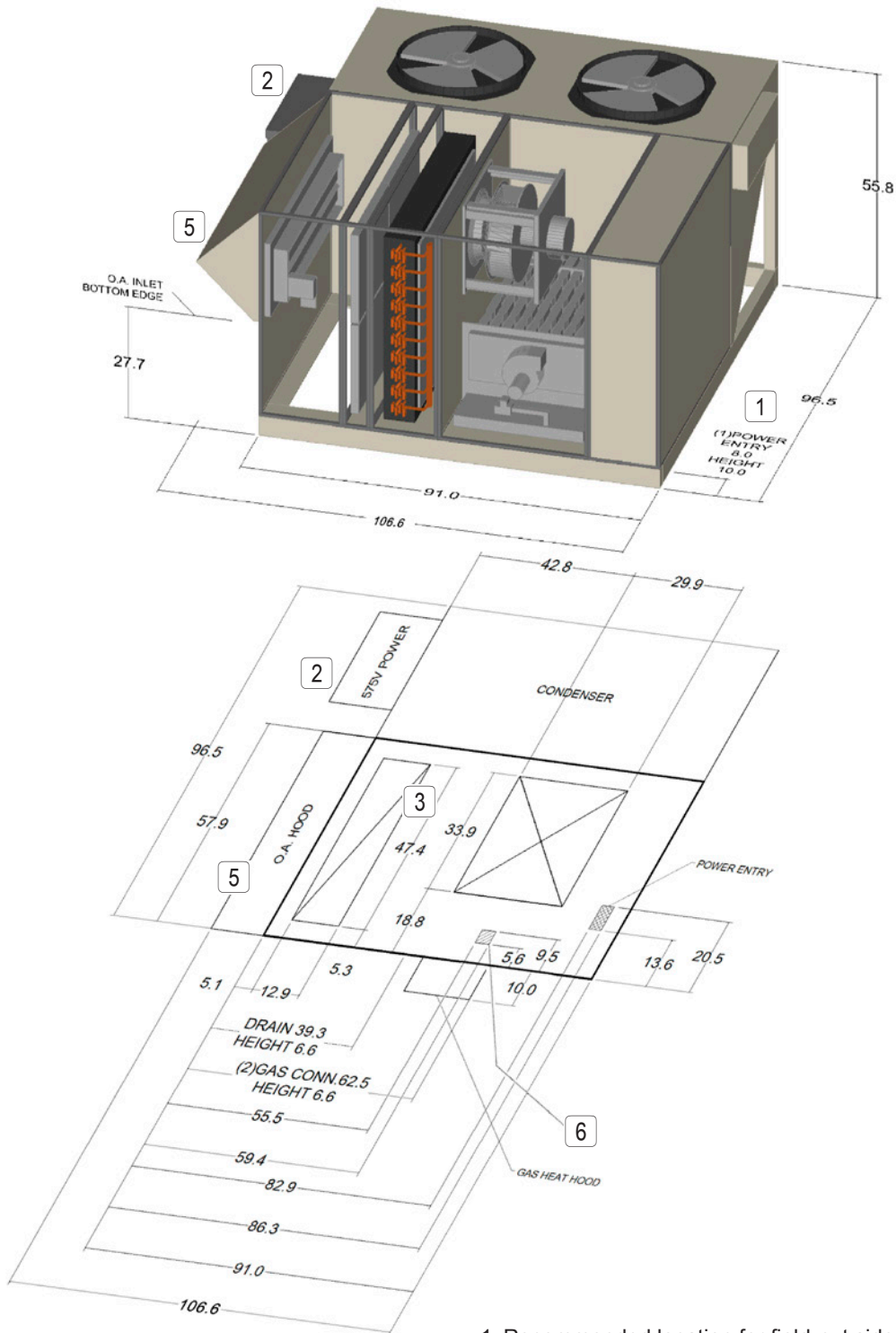
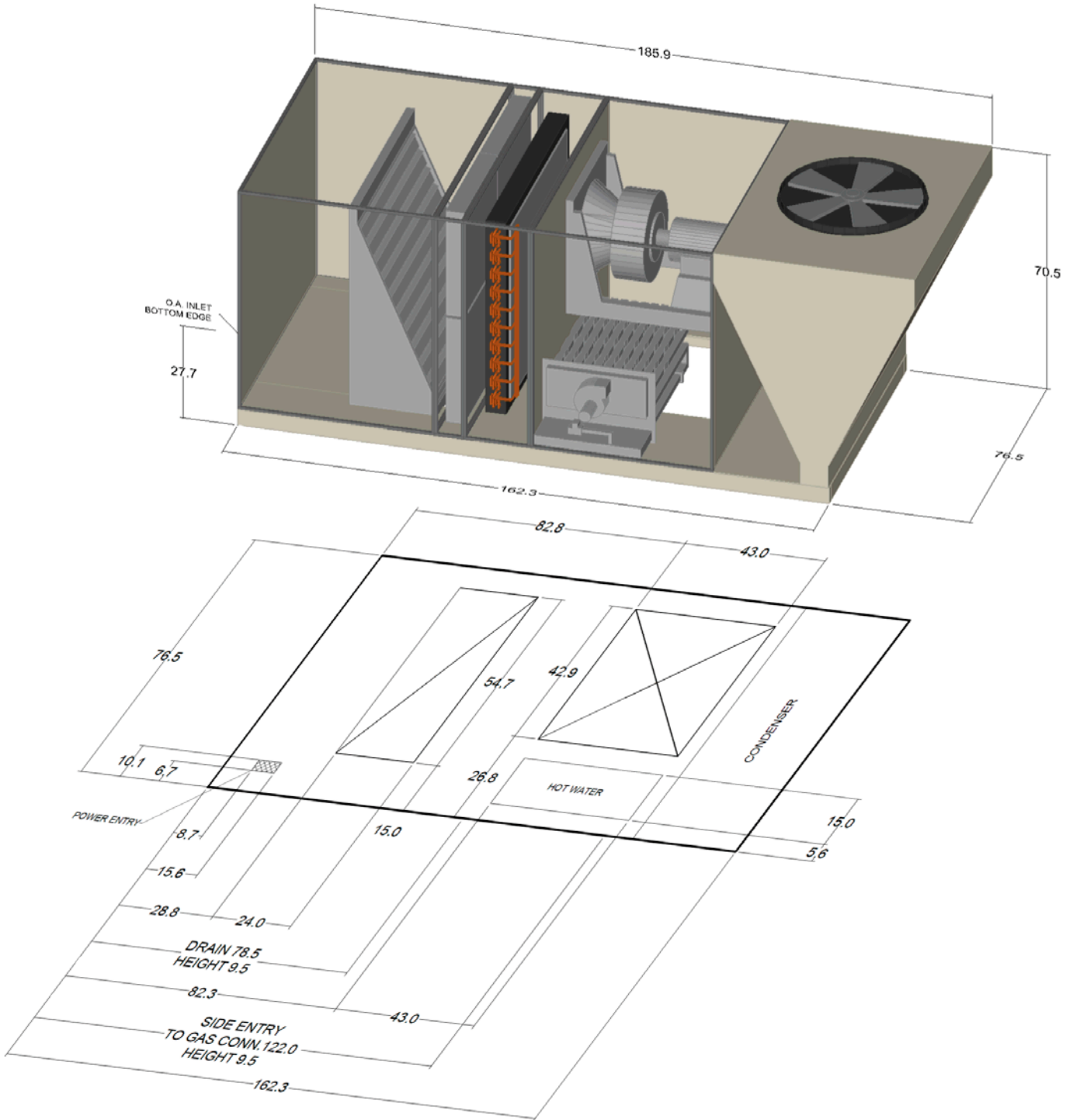

Figure 31: DPS 007-015, No Energy Recovery, 0-30% or 100% Outdoor Air



1. Recommended location for field-cut, side power opening
2. Only provided on 575 volt units
3. Not supplied on horizontal return or 100% OA units
4. Horizontal, above the roof, gas connection only
5. Not provided on 100% Return Air units
6. Optional field-cut hot water piping entrance

Figure 32: DPS 016–028, 30% or 100% Outdoor Air, No Energy Recovery



NOTE:
1. Recommended location for optional field-cut side power connection.

Figure 33: DPS 016–028, Economizer No Energy Recovery

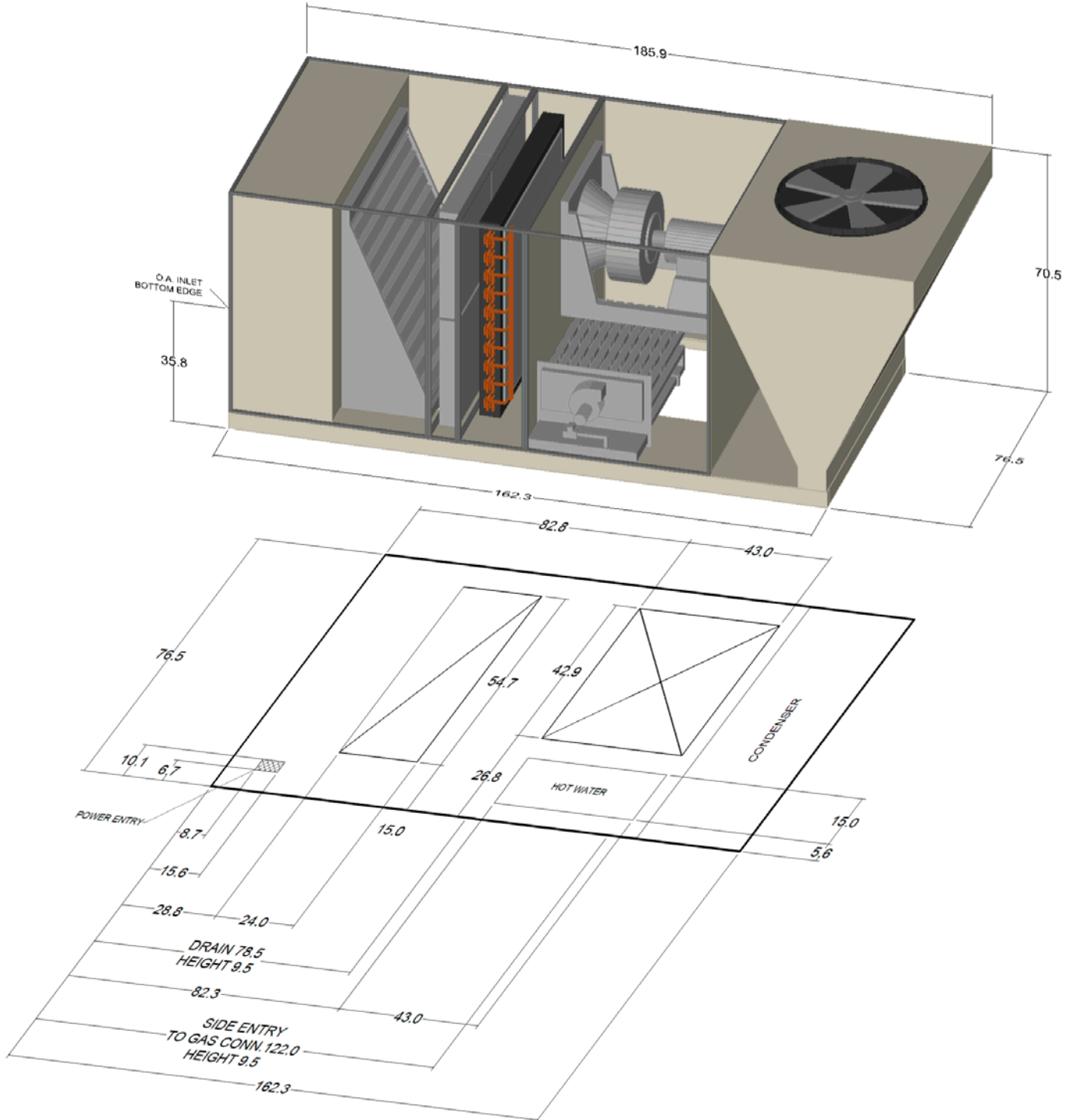

NOTE:

1. Recommended location for optional field-cut side power connection.
2. Horizontal gas connection only. Gas pipe routing within the roof curb is not available.

Figure 34: DPS 016–028, Energy Recovery

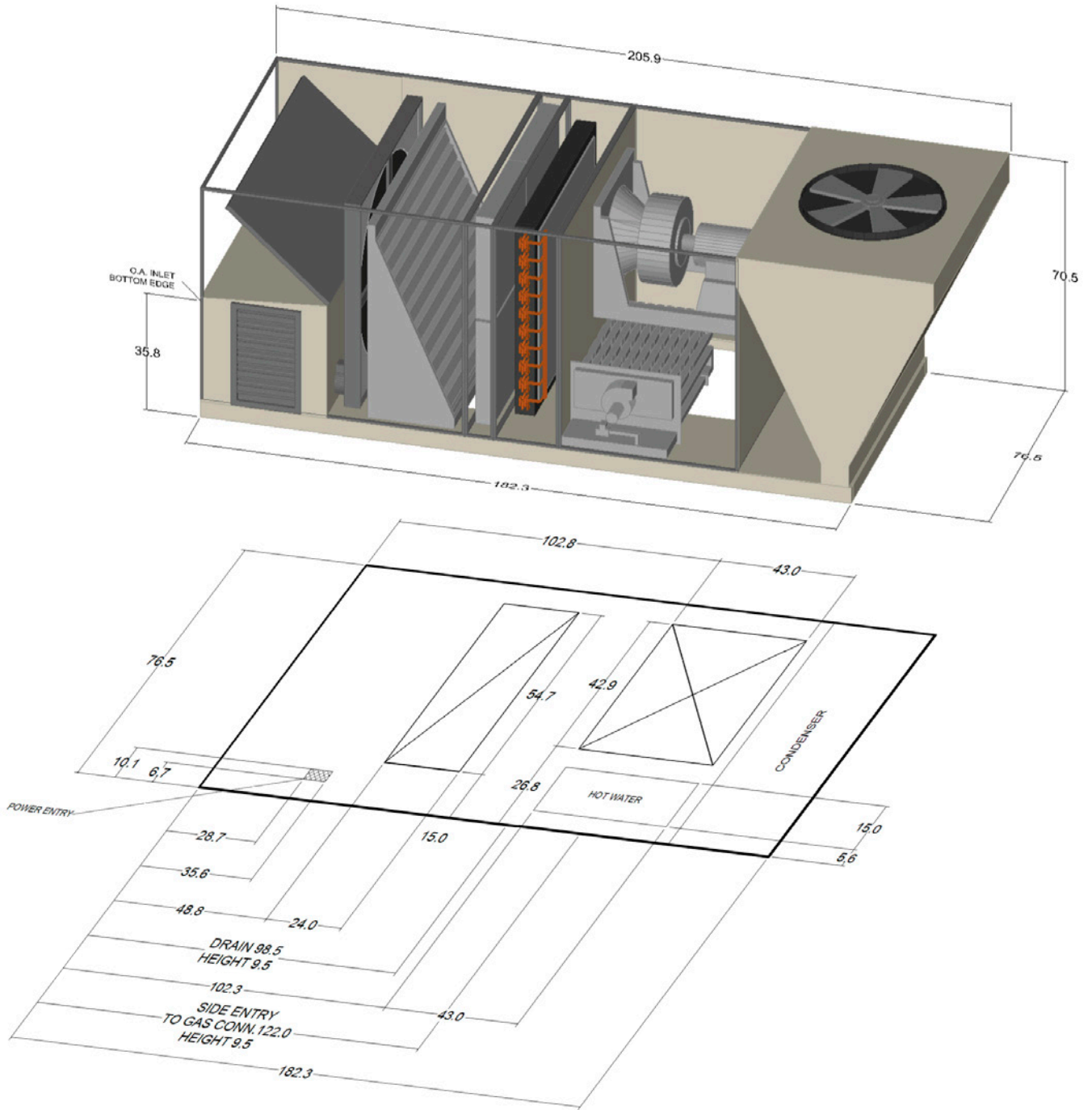

NOTE:

1. Recommended location for optional field-cut side power connection.
2. Horizontal gas connection only. Gas pipe routing within the roof curb is not available.

Table 13: DPS 003–015 Electric Heat Data¹

kW	Voltage	Amps
6	208	16.7
	230	15.1
	475	7.3
	575	6.0
12	208	33.3
	230	30.1
	475	14.6
	575	12.0
18	208	50.0
	230	45.2
	475	21.9
	575	18.1
30	208	83.3
	230	75.3
	475	36.5
	575	30.1
36	208	99.9
	230	90.4
	475	43.8
	575	36.1
54	208	149.9
	230	135.6
	475	65.6
	575	54.2
72	—	—
	—	—
	475	87.5
	575	72.3

1. Maximum temperature rise equals 60°F

Table 14: DPS 016–028 Electric Heat Data

KW	Voltage	Amps	KW	Voltage	Amps
30	208	83.4	90	208	250.1
	230	75.4		230	226.2
	460	37.7		460	113.1
	575	30.2		575	90.5
45	208	125.1	120	208	333.5
	230	113.1		230	301.6
	460	56.5		460	150.8
	575	45.2		575	120.6
60	208	166.7	150	208	416.9
	230	150.8		230	377.0
	460	75.4		460	188.5
	575	60.3		575	150.8

Rebel Minimum Circuit Ampacity [MCA] or Wire Sizing Amps

No electric heat

$$\text{MCA} = 1.25 \times \text{largest motor FRLA} + \text{sum of all other motor FRLA}$$

Heat Pump with electric heat where electric heat > 50 kW

$$\text{MCA} = 1.25 \times \text{largest motor FRLA} + \text{sum of all other motor FRLA} + \text{heater FLA}$$

Heat Pump with electric heat where electric heat is less than or equal to 50 kW

$$\text{MCA} = 1.25 \times [\text{heater FLA} + \text{largest motor FRLA}] + \text{sum of all other motor FRLA}$$

Not a heat pump with electric heat

Must calculate heat mode MCA and cool mode MCA and use the greater value.
Do not include compressors or condenser fans in the heat mode MCA.

$$\text{Cooling mode MCA} = 1.25 \times \text{largest motor FRLA} + \text{sum of all other motor FRLA}$$

Heating mode MCA where electric heat > 50 kW

$$\text{MCA} = 1.25 \times \text{largest motor FLA} + \text{sum of all other motor FLA} + \text{heater FLA}$$

Heating mode MCA where electric heat is less than or equal to 50 kW

$$1.25 \times [\text{heater FLA} + \text{largest motor FLA}] + \text{sum of all other motor FLA}$$

NOTE: FRLA = fan motor or controls full load amps or compressor rated load amps
FLA = fan motor or electric heat or controls full load amps
Control amps are:

Voltage	208	230	460	575
Gas Heat Units	2.36	2.16	1.08	0.86
All Other Units	1.18	1.08	0.54	0.43

Table 15: Amp Draw Data

Unit Size (Tons)	Compressor RLA										Compressor LRA								Condenser Fan FLA Each			
	Compressor 1 - Variable						Compressor 2 - Fixed				Compressor 1				Compressor 2				Qty	208	230	460
	Voltage						Voltage				Voltage				Voltage							
	208	230	460	575	[%]		208	230	460	575	208	230	460	575	208	230	460	575				
3	7.7	7.0	3.5	—	45%	0.0	0.0	0.0	—	See Note	0.0	0.0	0.0	—	1	0.9	0.8	0.4				
4	10.0	9.0	4.5	—	55%	0.0	0.0	0.0	—		0.0	0.0	0.0	—	1	0.9	0.8	0.4				
5	11.9	10.8	5.4	—	68%	0.0	0.0	0.0	—		0.0	0.0	0.0	—	1	2.0	1.8	0.9				
6	15.0	13.6	6.8	—	89%	0.0	0.0	0.0	—		0.0	0.0	0.0	—	1	2.0	1.8	0.9				
7.5	11.9	10.8	5.4	—	68%	8.6	7.8	3.9	—		67.5	73.7	37.1	—	2	2.0	1.8	0.9				
10	10.0	9.0	4.5	—	59%	17.5	15.8	7.9	—		93.1	84.2	42.1	—	2	2.0	1.8	0.9				
12	15.0	13.6	6.8	—	89%	17.5	15.8	7.9	—		93.1	84.2	42.1	—	2	2.0	1.8	0.9				
15	28.3	25.6	12.8	—	100%	17.5	15.8	7.9	—		93.1	84.2	42.1	—	2	2.0	1.8	0.9				
16	47.0	42.5	22.9	20.5	—	0	0	0	0		See Note	1	8.0	8.0	4.0							
18	47.0	42.5	22.9	20.5	—	0	0	0	0			1	8.0	8.0	4.0							
20	47.0	42.5	22.9	20.5	—	0	0	0	0			1	8.0	8.0	4.0							
25	47.0	42.5	22.9	20.5	—	39.1	35.4	18.6	15.4			1	8.0	8.0	4.0							
28	47.0	42.5	22.9	20.5	—	39.1	35.4	18.6	15.4			1	8.0	8.0	4.0							

NOTE: The inverter compressor is controlled to have a soft start and an LRA <1.0

Horse Power	Supply Fan FLA				Exhaust Fan FLA			
	Voltage				Voltage			
	208	230	460	kW	208	230	460	kW
1.3	3.1	2.8	1.4	1.0	3.1	2.8	1.4	1.0
2.3	5	4.6	2.3	1.7	5	4.6	2.3	1.7
4	8.8	7.4	4.0	3.0	8.8	7.4	4.0	3.0
8	13.5	12.2	6.1	6.0	—	—	—	—

575V Amp Draws: Compressors and motors will be run off a 575 to 460V transformer. Motors will be nameplated at 460V. 575 voltage is for large cabinet only.

Table 16: Recommended Field Power Wiring

Ampacity (MCA)	Number of Power Wires Per Phase	Wire Gauge	Insulation Temperature Rating (°C)
20	—	14	75
25	1	12	75
35	1	10	75
50	1	8	75
65	1	6	75
85	1	4	75
100	1	3	75
115	1	2	75
130	1	1	75
150	1	1/0	75
175	1	2/0	75
200	1	3/0	75
230	1	4/0	75
255	1	250	75

1. All wire sizes assume separate conduit for each set of parallel conductors.
2. All wire sizes based on NEC Table 310-16 for 75°C THW wire (copper). Canadian electrical code wire ampacities may vary.
3. All wire sizes assume no voltage drop for short power leads.

PART 1: GENERAL

1.01 SECTION INCLUDES

- A. Packaged Rooftop air conditioners

1.02 REFERENCES

- A. AFBMA 9 - Load Ratings and Fatigue Life for Ball Bearings.
- B. AMCA 99—Standards Handbook
- C. AMCA 500—Test Methods for Louver, Dampers, and Shutters.
- D. AHRI 340/360 - Unitary Large Equipment
- E. NEMA MG1—Motors and Generators
- F. National Electrical Code.
- G. NFPA 70—National Fire Protection Agency.
- H. SMACNA—HVAC Duct Construction Standards—Metal and Flexible.
- I. UL 900—Test Performance of Air Filter Units.

1.03 SUBMITTALS

- A. Shop Drawings: Indicate assembly, unit dimensions, weight loading, required clearances, construction details, field connection details, electrical characteristics and connection requirements.
- B. Product Data:
 1. Provide literature that indicates dimensions, weights, capacities, ratings, fan performance, and electrical characteristics and connection requirements.
 2. Provide computer generated fan curves with specified operating point clearly plotted.
 3. Manufacturer's Installation Instructions.

1.04 OPERATION AND MAINTANENCE DATA

- A. Maintenance Data: Provide instructions for installation, maintenance and service

1.05 QUALIFICATONS

- A. Manufacturer: Company specializing in manufacturing the Products specified in this section with minimum five years documented experience, who issues complete catalog data on total product.
- B. Startup must be done by trained personnel experienced with rooftop equipment.
- C. Do not operate units for any purpose, temporary or permanent, until ductwork is clean, filters and remote controls are in place, bearings lubricated, and manufacturers' installation instructions have been followed.

1.06 DELIVERY, STORAGE, AND HANDLING

- A. Deliver, store, protect and handle products to site.
- B. Accept products on site and inspect for damage.
- C. Store in clean dry place and protect from weather and construction traffic. Handle carefully to avoid damage to components, enclosures, and finish.

PART 2: PRODUCTS

2.01 MANUFACTURERS

- A. Basis of Design: Daikin Applied
 1. No equal exists. [Deducts for alternative equipment will be considered.]

2.02 GENERAL DESCRIPTION

- A. Furnish as shown on plans, Daikin Applied Rebel Single zone Heating and Cooling Unit(s) model DPS. Unit performance and electrical characteristics shall be per the job schedule.
- B. Configuration: Fabricate as detailed on prints and drawings:
 1. Return plenum / economizer section
 2. Filter section
 3. Cooling coil section
 4. Supply fan section
 5. Gas heating section.
 6. Condensing unit section
- C. The complete unit shall be cETLus listed.
- D. The unit shall be ASHRAE 90.1-2013 compliant and labeled.
- E. Each unit shall be specifically designed for outdoor rooftop application and include a weatherproof cabinet. Each unit shall be completely factory assembled and shipped in one piece. Packaged units shall be shipped fully charged with R-410 Refrigerant and oil.
- F. The unit shall undergo a complete factory run test prior to shipment. The factory test shall include a refrigeration circuit run test, a unit control system operations checkout, a unit refrigerant leak test and a final unit inspection.
- G. All units shall have decals and tags to indicate caution areas and aid unit service. Unit nameplates shall be fixed to the main control panel door. Electrical wiring diagrams shall be attached to the control panels. Installation, operating and maintenance bulletins and start-up forms shall be supplied with each unit.

- H. Performance: All scheduled EER, IEER, capacities and face areas are minimum accepted values. All scheduled amps, kW, and HP are maximum accepted values that allow scheduled capacity to be met.
- I. Warranty: The manufacturer shall provide 12-month parts only warranty. Defective parts shall be repaired or replaced during the warranty period at no charge. The warranty period shall commence at startup or six months after shipment, whichever occurs first.

2.03 CABINET, CASING, AND FRAME

- A. Panel construction shall be double-wall construction for all panels. All floor panels shall have a solid galvanized steel inner liner on the air stream side of the unit to protect insulation during service and maintenance. Insulation shall be a minimum of 1" [size 3-15] 2" [size 16-28] thick with an R-value of 7 [size 3-15] 13 [size 16-28,] and shall be 2 part injected foam. Panel design shall include no exposed insulation edges. Unit cabinet shall be designed to operate at total static pressures up to 5.0 inches w.g.
- B. Exterior surfaces shall be constructed of pre-painted galvanized steel for aesthetics and long term durability. Paint finish to include a base primer with a high quality, polyester resin topcoat of a neutral beige color. Finished panel surfaces to withstand a minimum 750-hour salt spray test in accordance with ASTM B117 standard for salt spray resistance.
- C. Service doors shall be provided on the fan section, filter section, control panel section, and heating vestibule in order to provide user access to unit components. All service access doors shall be mounted on multiple, stainless steel hinges and shall be secured by a latch system. Removable service panels secured by multiple mechanical fasteners are not acceptable. The unit base shall overhang the roof curb for positive water runoff and shall seat on the roof curb gasket to provide a positive, weather tight seal. Lifting brackets shall be provided on the unit base to accept cable or chain hooks for rigging the equipment.

2.04 ECONOMIZER SECTION

- A. Unit shall be provided with an outdoor air economizer section. The economizer section shall include outdoor, return, and exhaust air dampers. The economizer operation shall be fully integral to the mechanical cooling and allow up to 100% of mechanical cooling if needed to maintain the cooling discharge air temperature. The outdoor air hood shall be factory installed and constructed from galvanized steel finished with the same durable paint finish as the main unit. The hood shall include moisture eliminator filters to drain water away from the entering air stream. The outside and return air dampers shall be sized to handle 100% of the supply air volume. The dampers shall be parallel blade design. Damper blades shall be gasketed with side seals to provide an air leakage rate of 1.5 cfm / square foot of damper area at 1" differential pressure in accordance with testing defined in AMCA 500. A barometric exhaust damper shall be provided to exhaust air out of the back of the unit. A bird screen shall be provided to prevent infiltration of rain and foreign materials. Exhaust damper blades shall be lined with vinyl gasketing on contact edges. Control of the dampers shall be by a factory installed direct coupled actuator. Damper actuator shall be of the modulating, spring return type. A comparative enthalpy control shall be provided to sense and compare enthalpy in both the outdoor and return air streams to determine if outdoor air is suitable for "free" cooling. If outdoor air is suitable for "free" cooling, the outdoor air dampers shall modulate in response to the unit's temperature control system.
- B. Provide factory installed and tested, outdoor air monitor that controls outdoor air +/- 15% accuracy down to 40 cfm per ton.
- C. Economizer assembly shall be California Title 24 compliant. MicroTech III controls shall display a warning, and write a warning to the BAS, if the economizer malfunctions in accordance with Title 24 specifications.

2.05 EXHAUST FAN

- A. Exhaust fan shall be a single width, single inlet (SWSI) airfoil centrifugal fan. The fan wheel shall be Class II construction with aluminum fan blades that are continuously welded to the hub plate and end rim. The exhaust fan shall be a direct drive fan mounted to the motor shaft. Belts and sheaves are not acceptable due to the additional maintenance.
- B. The fan motor shall be a totally enclosed EC motor that is speed controlled by the rooftop unit controller. The motor shall include thermal overload protection and protect the motor in the case of excessive motor temperatures. The motor shall have phase failure protection and prevent the motor from operation in the event of a loss of phase. Motors shall be premium efficiency.

- C. The unit DDC controller shall provide building static pressure control. The unit controller shall provide proportional control of the exhaust fans from 25% to 100% of the supply air fan designed airflow to maintain the adjustable building pressure setpoint. The field shall mount the required sensing tubing from the building to the factory mounted building static pressure sensor.

2.06 COOLING COIL

- A. The indoor coil section shall be installed in a draw through configuration, upstream of the supply air fan. The coil section shall be complete with a factory piped cooling coil and an ASHRAE 62.1 compliant double sloped drain pan.
- B. The direct expansion (DX) cooling coils shall be fabricated of seamless high efficiency copper tubing that is mechanically expanded into high efficiency aluminum plate fins. Coils shall be a multi-row, staggered tube design with a minimum of 3 rows. All cooling coils shall have an interlaced coil circuiting that keeps the full coil face active at all load conditions. All coils shall be factory leak tested with high pressure air under water.
- C. The cooling coil shall have an electronic controlled expansion valve. The unit controller shall control the expansion valve to maintain liquid subcooling and the superheat of the refrigerant system.
- D. The refrigerant suction lines shall be fully insulated from the expansion valve to the compressors.
- E. The drain pan shall be stainless steel and positively sloped. The slope of the drain pan shall be in two directions and comply with ASHRAE Standard 62.1. The drain pan shall have a minimum slope of 1/8" per foot to provide positive draining. The drain pan shall extend beyond the leaving side of the coil. The drain pan shall have a threaded drain connection extending through the unit base.
- F. A drain pan over flow safety shall shut off the unit and issue a warning before over flow occurs.

2.07 SUPPLY FAN

- A. Supply fan shall be a single width, single inlet (SWSI) airfoil centrifugal fan. The fan wheel shall be Class II construction with blades that are continuously welded to the hub plate and end rim. The supply fan shall be a direct drive fan mounted to the motor shaft. Belts and sheaves are not acceptable due to the additional maintenance.
- B. All fan assemblies shall employ solid steel fan shafts. The entire fan assembly shall be isolated from the fan bulkhead with a flexible collar.

- C. All fan assemblies shall be statically and dynamically balanced at the factory, including a final trim balance, prior to shipment.
- D. Supply fan and motor assembly combinations larger than 8 hp or 22" diameter shall be internally isolated on 1" deflection, spring isolators and include removable shipping tie downs.
- E. Size 3-15 - The fan motor shall be a totally enclosed EC motor that is speed controlled by the rooftop unit controller. The motor shall include thermal overload protection and protect the motor in the case of excessive motor temperatures.
- F. Size 16-28 - the motor shall be T Frame and open drip proof. Ovrload protection and speed control is provided by the factory installed VFD and rooftop unit controller. The motor shall have phase failure protection and prevent the motor from operation in the event of a loss of phase. Motors shall be premium efficiency.
- G. The supply fan shall be capable of airflow modulation from 30% to 100% of the scheduled designed airflow. The fan shall not operate in a state of surge at any point within the modulation range.

2.08 VARIABLE AIR VOLUME CONTROL

- A. Size 3-15 Multiple Zone VAV–The unit controller shall proportionally control the Electronically Commutated Motors (ECM) on the supply and exhaust fans. The supply fan shall be controlled to maintain an adjustable duct pressure setpoint. A duct static pressure sensor shall be factory mounted in the control panel. The field shall furnish and install the pneumatic tubing for the duct static pressure sensor and the building pressure sensor. The field shall furnish and install the outdoor air pressure sensor.
- B. Size 3-15 Single Zone VAV–The unit controller shall proportional control the ECM motors on the supply fan based on space temperature. The unit controller shall increase/decrease the speed of the supply fan in order to maintain the space temperature within its setpoint and deadband. The unit controller shall provide discharge air temperature control with the compressor modulation.
- C. Size 16-28 an electronic variable frequency drive shall be provided for the supply air fan. Each drive shall be factory installed out of the air stream in a conditioned cabinet. Drives shall meet UL Standard 95-5V. The completed unit assembly shall be listed by a recognized safety agency, such as ETL. Drives are to be accessible through a hinged door assembly. Mounting arrangements that expose drives to high temperature unfiltered ambient air are not acceptable.
- D. The unit manufacturer shall install all power and control wiring.
- E. The supply air fan drive output shall be controlled by the factory installed main unit control system and drive status and operating speed shall be monitored and displayed at the main unit control panel.

2.09 HEATING SECTION

- A. The rooftop unit shall include a natural gas heating section. The gas furnace design shall be one natural gas fired heating module factory installed downstream of the supply air fan in the heat section. The heating module shall be a tubular design with in-shot gas burners.
- B. Each module shall have two stages of heating control.
- C. The heat exchanger tubes shall be constructed of stainless steel.
- D. The module shall have an induced draft fan that will maintain a negative pressure in the heat exchanger tubes for the removal of the flue gases.
- E. Each burner module shall have two flame roll-out safety protection switches and a high temperature limit switch that will shut the gas valve off upon detection of improper burner manifold operation. The induced draft fan shall have an airflow safety switch that will prevent the heating module from turning on in the event of no airflow in the flue chamber.
- F. The factory-installed DDC unit control system shall control the gas heat module. Field installed heating modules shall require a field ETL certification. The manufacturer's rooftop unit ETL certification shall cover the complete unit including the gas heating modules.

2.10 CONDENSING SECTION

- A. Outdoor coils shall be cast aluminum, micro-channel coils. Plate fins shall be protected and brazed between adjoining flat tubes such that they shall not extend outside the tubes. A sub-cooling coil shall be an integral part of the main outdoor air coil. Each outdoor air coil shall be factory leak tested with high-pressure air under water.
- B. Fan motors shall be an ECM type motor for proportional control. The unit controller shall proportionally control the speed of the condenser fan motors to maintain the head pressure of the refrigerant circuit from ambient condition of 0~120°F. Mechanical cooling shall be provided to 25° F. The motor shall include thermal overload protection and protect the motor in the case of excessive motor temperatures. The motor shall have phase failure protection and prevent the motor from operation in the event of a loss of phase.
- C. The condenser fan shall be low noise blade design. Fan blade design shall be a dynamic profile for low tip speed. Fan blade shall be of a composite material.

- D. The unit shall have scroll compressors. One of the compressors shall be an inverter compressor providing proportional control. The unit controller shall control the speed of the compressor to maintain the discharge air temperature. The inverter compressor shall have one of the following oil control features.
 - 1. A separate oil pump and an oil separator for each compressor that routes oil back to the compressor instead of through the discharge line.
 - 2. A separate oil pump and low oil safety protection [size 016-028].
- E. Pressure transducers shall be provided for the suction pressure and head pressure. Temperature sensor shall be provided for the suction temperature and the refrigerant discharge temperature of the compressors. All of the above devices shall be an input to the unit controller and the values be displayed at the unit controller.
- F. Each circuit shall be dehydrated and factory charged with R-410A Refrigerant and oil.

2.11 ELECTRICAL

- A. Unit wiring shall comply with NEC requirements and with all applicable UL standards. All electrical components shall be UL recognized where applicable. All wiring and electrical components provided with the unit shall be number and color-coded and labeled according to the electrical diagram provided for easy identification. The unit shall be provided with a factory wired weatherproof control panel. Unit shall have a single point power terminal block for main power connection. A terminal board shall be provided for low voltage control wiring. Branch short circuit protection, 115-volt control circuit transformer and fuse, system switches, and a high temperature sensor shall also be provided with the unit. Each compressor and condenser fan motor shall be furnished with contactors and inherent thermal overload protection. Supply fan motors shall have contactors and external overload protection. Knockouts shall be provided in the bottom of the main control panels for field wiring entrance.
- B. An optional fused disconnect and 65,000 amp SCCR capability shall be provided.

2.12 CONTROLS

- A. Provide a complete integrated microprocessor based Direct Digital Control (DDC) system to control all unit functions including temperature control, scheduling, monitoring, unit safety protection, including compressor minimum run and minimum off times, and diagnostics. This system shall consist of all required temperature sensors, pressure sensors, controller and keypad/display operator interface. All MCBs and sensors shall be factory mounted, wired and tested.
- B. The stand-alone DDC controllers shall not be dependent on communications with any on-site or remote PC or master control panel for proper unit operation. The microprocessor shall maintain existing set points and operate stand alone if the unit loses either direct connect or network communications. The microprocessor memory shall be protected from voltage fluctuations as well as any extended power failures. All factory and user set schedules and control points shall be maintained in nonvolatile memory. No settings shall be lost, even during extended power shutdowns.
- C. The DDC control system shall permit starting and stopping of the unit locally or remotely. The control system shall be capable of providing a remote alarm indication. The unit control system shall provide for outside air damper actuation, emergency shutdown, remote heat enable/disable, remote cool enable/disable, heat indication, cool indication, and fan operation.
- D. All digital inputs and outputs shall be protected against damage from transients or incorrect voltages. All field wiring shall be terminated at a separate, clearly marked terminal strip
- E. The DDC controller shall have a built-in time schedule. The schedule shall be programmable from the unit keypad interface. The schedule shall be maintained in nonvolatile memory to insure that it is not lost during a power failure. There shall be one start/stop per day and a separate holiday schedule. The controller shall accept up to sixteen holidays each with up to a 5-day duration. Each unit shall also have the ability to accept a time schedule via BAS network communications.
- F. The keypad interface shall allow convenient navigation and access to all control functions. The unit keypad/display character format shall be 4 lines x 20 characters. All control settings shall be password protected against unauthorized changes. For ease of service, the display format shall be English language readout. Coded formats with look-up tables will not be accepted. The user interaction with the display shall provide the following information as a minimum:
 1. Return air temperature.
 2. Discharge air temperature.
 3. Outdoor air temperature.
 4. Space air temperature.
 5. Outdoor enthalpy, high/low.
 6. Compressor suction temperature and pressure
 7. Compressor head pressure and temperature
 8. Expansion valve position
 9. Condenser fan speed
 10. Inverter compressor speed
 11. Dirty filter indication.
 12. Airflow verification.
 13. Cooling status.
 14. Control temperature (Changeover).
 15. VAV box output status.
 16. Cooling status/capacity.
 17. Unit status.
 18. All time schedules.
 19. Active alarms with time and date.
 20. Previous alarms with time and date.
 21. Optimal start
 22. Supply fan and exhaust fan speed.
 23. System operating hours.
 - a. Fan
 - b. Exhaust fan
 - c. Cooling
 - d. Individual compressor
 - e. Heating
 - f. Economizer
 - g. Tenant override

- G. The user interaction with the keypad shall provide the following:
 - 1. Controls mode
 - a. Off manual
 - b. Auto
 - c. Heat/Cool
 - d. Cool only
 - e. Heat only
 - f. Fan only
 - 2. Occupancy mode
 - a. Auto
 - b. Occupied
 - c. Unoccupied
 - d. Tenant override
 - 3. Unit operation changeover control
 - a. Return air temperature
 - b. Space temperature
 - c. Network signal
 - 4. Cooling and heating change-over temperature with deadband
 - 5. Cooling discharge air temperature (DAT)
 - 6. Supply reset options
 - a. Return air temperature
 - b. Outdoor air temperature
 - c. Space temperature
 - d. Airflow (VAV)
 - e. Network signal
 - f. External (0-10 vdc)
 - g. External (0-20 mA)
 - 7. Temperature alarm limits
 - a. High supply air temperature
 - b. Low supply air temperature
 - c. High return air temperature
 - 8. Lockout control for compressors.
 - 9. Compressor interstage timers
 - 10. Night setback and setup space temperature.
 - 11. Building static pressure.
 - 12. Economizer changeover
 - a. Enthalpy
 - b. Drybulb temperature
 - 13. Currently time and date
 - 14. Tenant override time
 - 15. Occupied/unoccupied time schedule
 - 16. One event schedule
 - 17. Holiday dates and duration
 - 18. Adjustable set points
 - 19. Service mode
 - a. Timers normal (all time delays normal)
 - b. Timers fast (all time delays 20 sec)
- H. If the unit is to be programmed with a night setback or setup function, an optional space sensor shall be provided. Space sensors shall be available to support field selectable features. Sensor options shall include:
 - 1. Zone sensor with tenant override switch
 - 2. Zone sensor with tenant override switch plus heating and cooling set point adjustment. (Space Comfort Control systems only)
- I. To increase the efficiency of the cooling system the DDC controller shall include a discharge air temperature reset program for part load operating conditions. The discharge air temperature shall be controlled between a minimum and a maximum discharge air temperature (DAT) based on one of the following inputs:
 - 1. Airflow
 - 2. Outside air temperature
 - 3. Space temperature
 - 4. Return air temperature
 - 5. External signal of 1-5 vdc
 - 6. External signal of 0-20 mA
 - 7. Network signal

2.13 CLOUD-ENABLED EQUIPMENT

A. Summary

1. The manufacturer shall provide a factory-installed equipment and facility management solution, which resides on the HVAC equipment. The solution shall provide monitoring, control, analysis, and decision-making capabilities using secure, cloud-communicating hardware. Capabilities shall include integrated equipment power measurement. Solution should be able to communicate to a user device (smart phone, tablet, etc.) via wireless (cellular, Wi-Fi) or local area network (LAN) connection. The subscription-based Software as a Service (SaaS) shall be available with one or more users views that provide site asset management, monitoring and controlling individual HVAC units. The solution shall provide cloud-based access to third party content, such as weather, utility, and CRM data. Equipment hardware shall consist of all components necessary to deliver unit controller and power data directly to the cloud.

B. MACHINE TO MACHINE (M2M) GATEWAY

1. A factory-installed, tested and commissioned Machine to Machine (M2M) Gateway shall deliver data directly to the cloud via wireless (cellular, Wi-Fi) or local area network (LAN) connection. Upon communication failure in one mode, solution shall be capable of automatically switching over to another means of connecting to the cloud.
2. The Machine (M2M) Gateway shall implement security, to include:
 - a. Data delivery via secure HTTPS using SSL
 - b. Virus and Malware protection
 - c. Boot-level security
3. Hardware shall meet or exceed the following specifications:
 - a. Intel Atom 1Ghz E640T processor + EG20T
 - b. 1 GB Memory
 - c. 8G SATA Fixed Storage
 - d. 802.11 a/b/g/n Wi-Fi – Client
 - e. 802.11 a/b/g/n Wi-Fi – Host
 - f. Integrated Cellular SIM Holder
 - g. Interfaces: RS-232; RS-485; USB 2.0; Wi-Fi Antenna Port; Cellular Antenna Port; Ethernet (Gigabit).
 - h. Operating Environment: Operates in a temperature range of -40 to 158 degrees F. (-40 to 70 degrees C.). Relative humidity range of < 90%.
 - i. RoHS Compliant
 - j. Vibration/Shock: MIL-STD-810F

k. EMC: CE, FCC, IC

l. Safety: CE, UL, cUL, CB

m. Power Regulation: SAE J1455, ISO 7637-2, SAE J1113

n. PTCRB Certification

C. ENERGY MANAGEMENT MODULE

1. A factory-installed, tested and commissioned Energy Management Module (EMM), or equivalent, shall monitor unit voltage, current, and power and transmit this data to the Machine to Machine (M2M) Gateway for delivery to the Cloud.
2. Hardware shall meet or exceed the following specifications:
 - a. Allow monitoring of single-phase, split-phase and 3-phase Y & Delta connections Module up to 600VAC (45-65 Hz) and up to 1000 A
 - b. Allow an Operating Range of -40 to 185°F (-40 to 85°C) and Relative humidity > 90%, non-condensing
 - c. UL 873, UL 916 recognized and the equivalent Canadian standard as a Test and Measurement Equipment in Industrial environments
 - d. Comply with IEC 61032 finger safe for the terminal strip used (required for safety on safety)

D. INSTALLATION

1. Antennas shall be shipped loose from the factory, and shall be mounted and electrically-connected in the field by the contractor providing unit start-up and commissioning, per factory-supplied installation literature.
2. For sites using Local Area Network (LAN) connection to provide Cloud access, appropriate trades should coordinate to supply all necessary roof penetrations, conduit, network cable, network infrastructure, and termination to the network.

E. START-UP AND COMMISSIONING

1. Initial programming of Site information, Unit List, and User List and accompanying Passwords, shall be performed at the factory.
2. Technical and Customer users will complete the IE invitation process to gain access the UI for the connected equipment

2.14 ROOF CURB

- A. A prefabricated heavy gauge galvanized steel, mounting curb shall be provided for field assembly on the roof decking prior to unit shipment. The roof curb shall be a full perimeter type with complete perimeter support of the air handling section and condensing section. The curb shall be a minimum of 14" high and include a nominal 2"x4" wood nailing strip. Gasket shall be provided for field mounting between the unit base and roof curb.



Daikin Applied Training and Development

Now that you have made an investment in modern, efficient Daikin equipment, its care should be a high priority. For training information on all Daikin HVAC products, please visit us at www.DaikinApplied.com and click on Training, or call 540-248-9646 and ask for the Training Department.

Warranty

All Daikin equipment is sold pursuant to its standard terms and conditions of sale, including Limited Product Warranty. Consult your local Daikin Applied representative for warranty details. To find your local Daikin Applied representative, go to www.DaikinApplied.com.

Aftermarket Services

To find your local parts office, visit www.DaikinApplied.com or call 800-37PARTS (800-377-2787). To find your local service office, visit www.DaikinApplied.com or call 800-432-1342.

This document contains the most current product information as of this printing. For the most up-to-date product information, please go to www.DaikinApplied.com.

Products manufactured in an ISO Certified Facility.