

# PACKAGED TERMINAL AIR CONDITIONERS AND HEAT PUMPS WITH OUR DIGISMART® CONTROL BOARD & EMS

## DigiSmart PTAC SPECIFICATIONS AND ACCESSORIES CATALOG



## STANDARD FEATURES

- **Energy Efficiencies:** With EERs up to 11.7 and COPs up to 3.4, our unit's high efficiencies may qualify you for many of the rebates offered by electrical power companies.
- **Quiet Operation:** Our PTAC has been redesigned to be the quietest PTAC we've ever built. The unit's state-of-the-art design and construction provide a quiet environment, allowing guests to enjoy peaceful, sleep-filled nights.
  - Two fan motors (indoor/outdoor)
  - Indoor tangential fan for quiet operation
  - STC of 28
- **Assembled in the USA for 30 years:** assembled at our plant in Fayetteville, TN, using Goodman resources including engineering, production, and testing.
- **Increased Dehumidification Capacity:** Maintain lower humidity levels in rooms while cooling them without the need for expensive add-ons. As a result, guests feel more comfortable at higher temperatures, thus reducing cooling costs.
- **Seven-Button Touch Pad:** Provides complete control to guests for in-room comfort while maintaining energy efficiency.
- **Five-Year Limited Warranty:** Enjoy one of the most comprehensive warranties in the industry: First Year: parts & labor; Second through fifth years: parts & labor on certain sealed system components; second through fifth years: on certain functional parts only. For complete warranty details, visit [www.amana-ptac.com](http://www.amana-ptac.com).
- **100% Run Tested:** All units are 100% run tested at our plant in Fayetteville, TN, including leak checks during manufacturing and again prior to shipment at the warehouse.
- **7 $\frac{5}{8}$ " Unit Front Depth:** Enhance valuable room space with our slim unit front, which has a sleek 7 $\frac{5}{8}$ " depth, one of the shallowest silhouettes in the industry today. In addition, to inhibit guest-tampering, the front can be secured to the chassis with a hidden screw.
- **Removable Condenser Shroud:** Allows easy access to enable regular cleaning of coils, which is essential to maintain unit efficiency and protect the compressor for long unit life.
- **Easy Pull-Out Filters:** Our filters are washable and easy to maintain.
- **Filter Dryer for Sealed System Refrigerant:** Standard in all units to protect the compressor and lengthen the life of the unit by removing moisture and preventing acid formation.

 **DigiSmart** CONTROL BOARD



## STANDARD FEATURES (CONT.)

- **Condensate Dispersion System:** Our condensate dispersion system removes condensate from indoor cooling operation by throwing water directly on to the outdoor coil for rapid evaporation and increased cooling efficiencies. The slinger ring on the new, enhanced fan draws water up and into the fan blades. This water is then atomized and evaporated into the atmosphere through the condenser. Increased surface area from the coil allows more water to be evaporated on the sides of the coils and helps to minimize condensate run-off.
- **Front Desk Control:** Each unit comes equipped with the DigiSmart™ control and energy management software. With Digi-Smart™ using the optional RF Antennae, all units can be wirelessly connected to a central hub for enhanced energy savings and diagnostics. Amana brand PTACs also have a low-voltage interface capability with a field-supplied front-desk ON/OFF switch. (See Page 4.)
- **Room Freeze Protection:** When the unit senses temperatures of 40°F or below, the unit activates the fan motor and either the electric resistance heater or the hydronic heater.
- **Easy-to-use Controls:** No complex controls to confuse your guests and create phone calls for your manager. Controls are easy to read, understand, and activate. Our new 7-button control panel provides guests with complete control of the unit for their in-room comfort while maintaining overall energy efficiency.
- **Easy to Service with On-Board LED Diagnostics:** The main components are easily serviced and there is no guessing to determine the problem with our easy-to-read diagnostics.
- **Stonewood Room Front:** Our Stonewood room front strikes the balance between attractive styling and practical design. Distinctive contours and a modern appearance enhance the character of even the most luxurious room, while the sleek 7 $\frac{3}{8}$ " depth maximizes usable space for your guests.
- **Remote Thermostat Control:** When the DigiSmart™ wireless remote thermostat (DS01E, sold separately) is set up, both the remote thermostat and unit control panel continue to control the unit, providing flexibility and home-like system control. Installation requires no more than pressing two buttons. No need to run wires or make electrical connections.
- **Remote Temperature Sensing:** Guests enjoy ultimate comfort with consistent climate control. When the field-installed thermistor (RTS03) is used, the unit-mounted thermostat is overridden to allow more accurate, internal wall-sensing of room ambient temperature.
- **Extended Heat Pump Heating:** Heat pump models will operate in the heating mode down to as low as 24°F outdoor ambient temperature.
- **Zero Floor Clearance:** The unit can be installed flush to a finished floor, if desired. (Some accessories do not have zero clearance).
- **30-Second Fan-Off Delay:** The fan continues to run 30 seconds after the compressor has stopped in either cooling or heat pump mode and after electric heat has been turned off. This improves efficiency by dispersing the conditioned air on the coils into the room.
- **Compressor Lock-In:** This feature helps prolong the life of the compressor by preventing short-cycling. When the compressor is switched from Off to On because room temperature has risen or fallen below the specified limit, it will remain on for at least 4 minutes. If the temperature set-point is changed during this 4 minutes, the lock-in feature is overridden.
- **Automatic Emergency Heat:** No more "my unit is not heating" complaints during the middle of the night. Heat pump units will automatically switch over to electric resistance heat if the heat pump compressor system fails or if the heating load is greater than the unit capacity.
- **Constant Fan Mode:** Take advantage of each unit's dual options — select continuous fan operation or cycle the fan ON and OFF with the thermostat. Our new 7-button design allows guests to select fan performance while allowing the owner to have the unit revert to the desired program of continuous fan or cycle with conditioning.
- **Hidden Ventilation Control:** The ventilation control lever is hidden from the occupant's view to allow you to manage ventilation requirements.
- **High-Pressure Switch:** Protects the unit from high pressure and damage to the unit, helping to ensure long unit life.



brings together our best PTAC ever with our best Energy Management Software and now integration with Property Management and Front Desk Management Software. Reduce PTAC energy consumption by 35% OR MORE\* through the power of the in-unit Energy Management System, programmable temperature set-back and limits combined. Reduce PTAC maintenance cost through our automated maintenance notification system. Improved maintenance sustains energy efficiency (EER) and prolongs PTAC life, keeping equipment running at its designed efficiency level and room guests more comfortable.

## THE AMANA BRAND DIGISMART SOLUTION

### IN-ROOM: “SELF-INSTALLABLE” WIRELESS PERIPHERALS



The DigiSmart Occupancy Sensor completes the in-room equipment. This infrared sensor can determine if the room is occupied or empty, and when empty signals the PTAC to adjust the temperature to save energy based on programmable setbacks.

The DigiSmart Wireless Remote Thermostat can mount on the wall anywhere in the guest room. Battery powered and with its own wireless ability to communicate with the PTAC to maintain room temperature. Best of all, no wires to run. The PTAC and Thermostat connect at the press of a button and are permanently linked. The thermostat and PTAC work in-sync to display accurate temperature.

The DigiSmart Wireless Antenna installs inside the PTAC with a snap-in connector. Installing the antenna allows the PTAC to communicate wirelessly with other devices in the room and to the DigiSmart network.

- > 45,000+ rooms have had wireless installations since 2005
- > Total wireless devices deployed to date: 120,000+

The Amana brand DigiSmart PTAC with antenna, combined with the self-installable, wireless Thermostat and Occupancy Sensor give the property owner complete control over the equipment settings and can reduce PTAC energy usage by 35% OR MORE.\*

### SITE-LEVEL — CENTRAL WIRELESS CONTROLLER

- > Site-wide PTAC Configuration
- > Site-wide PTAC Diagnostics
- > Front Desk System Interface
- > Email Reporting
- > Internet Accessible Web User Interface Enterprise

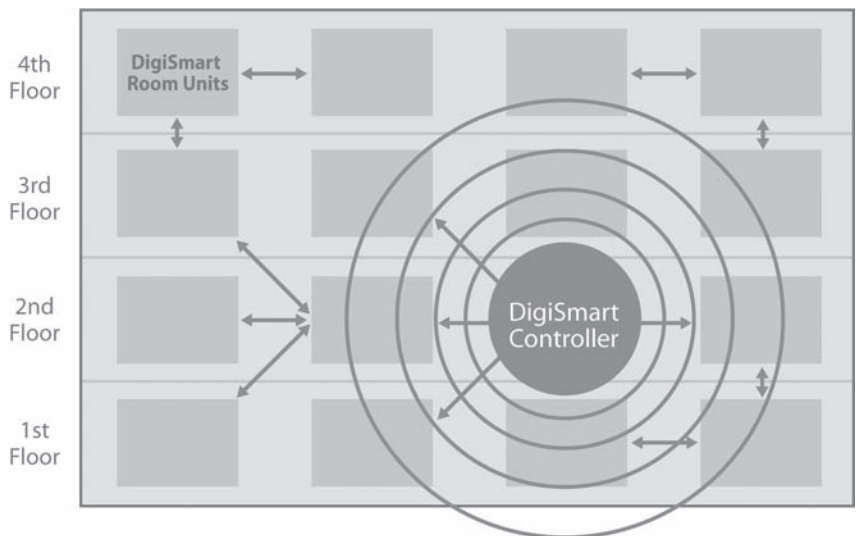

\* These savings represent estimated savings over time as compared to the same PTAC model without the DigiSmart EMS System installed and were generated using general assumptions including energy loads, local weather averages and use of occupancy controls. Actual savings will vary according to actual use habits, room square footage, and how the unit is installed.

## ENTERPRISE — MULTIPLE WIRELESS CONTROLLERS

### CENTRAL MONITORING AND CONTROL OF MULTIPLE PROPERTIES

- > Data Warehousing
- > Savings Analysis
- > Email Reporting
- > Virtual Metering
- > Load Shedding

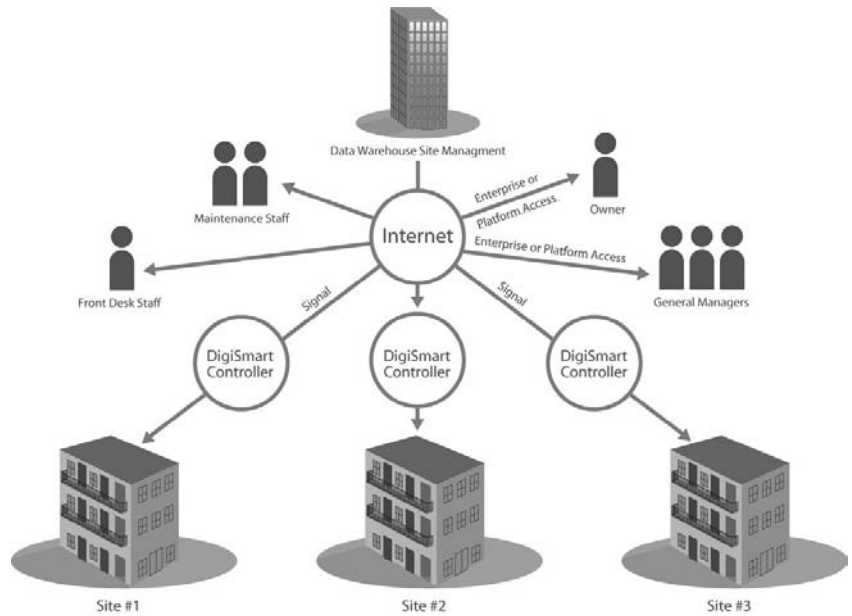

## WEB-BASED, REAL-TIME MONITORING

### AMANA® BRAND DIGISMART™ CONTROLLER:

All of the PTACs in the building can be managed through a single interface on a PC.

FEATURES INCLUDE: Full unit details for every PTAC, visible from the front desk or home office, automatic emails for PTAC maintenance, ability to change all settings on the unit, and enhanced diagnostics. Monitor up to 170 PTACs, WIRELESSLY, with one controller. Additional controllers can expand the network for additional rooms/properties.

- > System Verification
- > Global Setbacks
- > EMS Configuration
- > Site Statistics
- > Battery Notices
- > Email Reporting
- > Unit Health
- > Unit Code Alerts

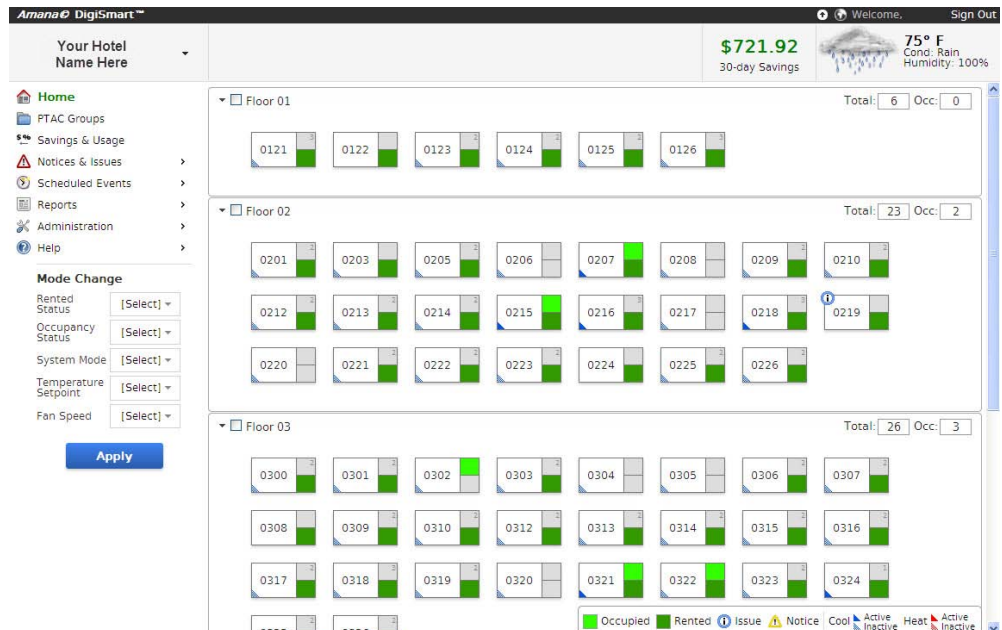

Temp Limiting – Each PTAC can be configured with a heating and cooling temperature set-point limit.

Setbacks – Once a room is declared unoccupied by the occupancy sensor, the PTAC progresses through three different temperature setbacks, configured as three degree and time pairs (An example configuration is listed below).

- 1st: 2°, 30 mins – Setback the temp 2 degrees after 30 minutes
- 2nd: 4°, 1 hr – Setback the temp 2 more degrees after 30 more minutes
- 3rd: 8°, 3 hrs – Setback the temp 4 more degrees after 2 more hours

Unrented Set-Points – By integrating with your property's Front Desk System, the PTACs will adjust to specific set-points when no longer identified as rented in the system.

# NOMENCLATURE

		PTC	07	3	G	35	AXXX	AA			
		1,2,3	4	5	6	7,8,9	10,11,12,13	14			
<b>Basic Model Type</b>									<b>Engineering</b>		
PTC	Standard Cooler PTAC								Major & Minor Revisions		
PTH	Standard Heat Pump PTHP										
DRY	Dehumid Cooler PTAC										
<b>Cooling Capacity</b>									<b>Features Code</b>		
07	7000 BTU/h	60 Hz									
09	9000 BTU/h	60 Hz									
10	10000 BTU/h	50 Hz									
12	12000 BTU/h	50 or 60 Hz									
15	14000 BTU/h	60 Hz									
<b>Rated Voltage</b>									A Standard Model		
2	115V, 60 Hz, 1 Ph									C Corrosion Protection (Seacoast)	
3	230/208V, 60 Hz, 1 Ph									D Power Door	
4	265V, 60 Hz, 1 Ph									F Fuse Holder (230/208 Only)	
5	240/220V, 50 Hz, 1 Ph									H Hydronic Heat-Capable	
<b>Design Series</b>									P Condensate Pump (PTH Only)		
G	R-410A								Q Quiet STC 31 Chassis		
<b>Heater Size</b>									R RF Antenna		
00	No Electric Heat	35	3.5 kW (230/208V)								
15	1.5 kW		3.7 kW (265V)								
25	2.5 kW	50	5.0 kW								
									V Power Vent		
									X placeholder		
									W Hard-Wired (PTQC)		
									Use up to 4 as needed in alphabetical order		
									Examples:		
				PTC123E50AXXX				PTC073E35CRXX			
				PTC123E50CXXX				PTC073E25CQRW			

# POWER CORD CONFIGURATION

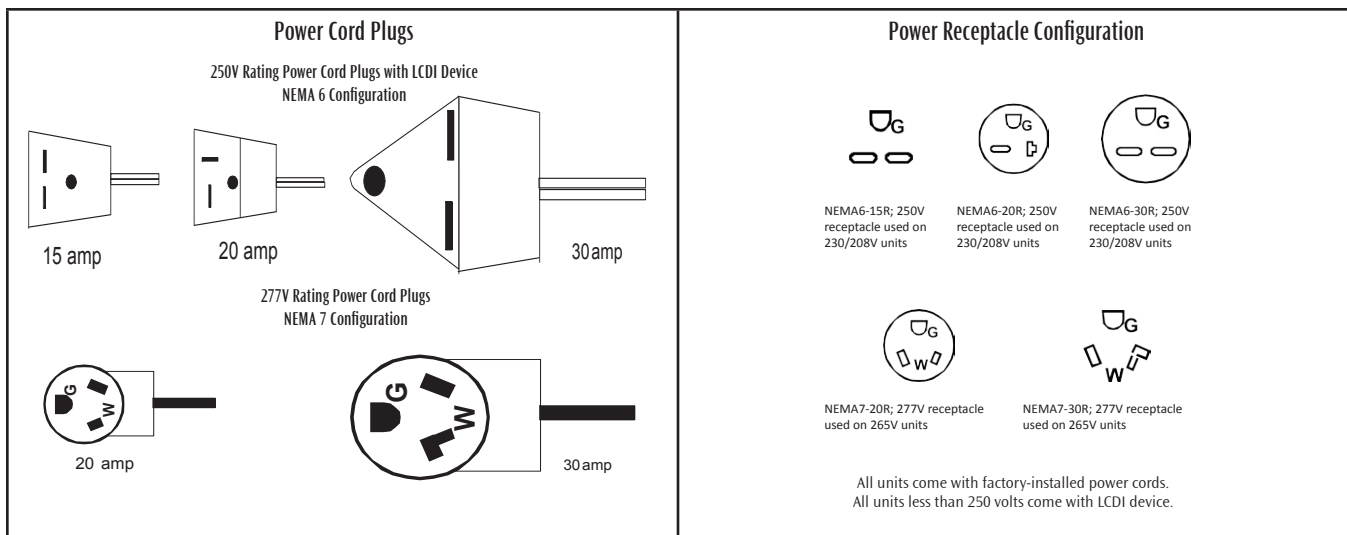

# PRODUCT SPECIFICATIONS: PTC MODELS — COOLING/ELECTRIC HEAT



## 230/208 VOLTS

MODEL <sup>6, 8, 9</sup>	PTC 073G***XXX	PTC 093G***XXX	PTC 123G***XXX	PTC 153G***XXX
Voltage <sup>3</sup>	230 / 208	230 / 208	230 / 208	230 / 208
Capacity (BTU/h)	7,700	9,000	11,700 / 11,500	15,000 / 14,700
Amps <sup>10</sup>	3.5	4.1	5.6	7.0
Watts <sup>10</sup>	670/660	805/785	1135/1105	1500/1470
EER	11.5	11.2/11.5	10.3/10.4	10.0/10.0
<b>UNIT WITHOUT ELECTRIC HEATER</b>				
Min. Circuit Amps <sup>2, 4, 10</sup>	4.2	4.9	6.8	8.5
CFM (Cool/Wet Coil)	High	290	290	340
	Low	264	264	314
CFM (Dry Coil)	High	310	310	360
	Low	282	282	332
Ventilated Air, CFM (Fan Only)*	65*	65*	65*	65*
Dehumidification (Pints/Hr.)	1.7	2.2	3.6	4.4
Net Weight (lbs.)	98	102	102	113
Ship Weight (lbs.)	113	117	119	130

## 265/277 VOLTS

Model <sup>1, 6, 8</sup>	PTC 074G***XXX	PTC 094G***XXX	PTC 124G***XXX	PTC 154G***XXX
Voltage <sup>1, 3</sup>	265	265	265	265
Capacity (BTU/h)	7,700	9,000	12,000	14,800
Amps <sup>10</sup>	3.0	3.6	4.8	6.0
Watts <sup>10</sup>	670	795	1,165	1,480
EER	11.5	11.3	10.3	10.0
<b>UNIT WITHOUT ELECTRIC HEATER</b>				
Min. Circuit Amps <sup>2, 4, 10</sup>	3.6	4.4	5.9	7.4
CFM (Cool/Wet Coil)	High	290	290	340
	Low	264	264	314
CFM (Dry Coil)	High	310	310	360
	Low	282	282	332
Ventilated Air, CFM (Fan Only)*	65*	65*	65*	65*
Dehumidification (Pints/Hr.)	1.7	2.2	3.6	4.4
Net Weight (lbs.)	98	102	102	113
Ship Weight (lbs.)	113	117	119	130

\* Actual vent CFM performance will vary due to application and installation conditions.

### NOTES

- All 265-volt models must use an Amana® brand sub-base (PTSB4\*\*E) or an Amana® brand hard-wire kit PTPWHWK4 and disconnect switch PSHW04A.
- Minimum Circuit Ampacity (MCA) ratings conform to the National Electric Code; however, local codes should apply.
- Minimum voltage on 230/208-volt models is 197 volts; maximum is 253 volts. Minimum voltage on 265-volt models is 239 volts; maximum is 292 volts.
- Overcurrent protection for all units without electric heaters is 15 amps. Overcurrent protection on 265-volt models must be cartridge-style time-delay fuses (included and factory-installed on all Amana® brand 265-volt chassis). See heater performance.
- Heating capacity and efficiency based on unit operation without condensate pump; unit automatically switches to electric heat at approximately 24°F outdoor ambient.
- Specify two-digit heater kW size to complete model number.
- R-410A refrigerant used in all systems.
- All units meet or exceed ASHRAE 90.1 standards.
- All units less than 250 volts have a Leak Current Detector Interrupter (LCDI) power cord and meet UL 484 standards.
- Refer to electric heat performance data for total MCA and recommended overcurrent protection. Amps and Watts notation refers to compressor only.

# PRODUCT SPECIFICATIONS: PTH MODELS — COOLING/HEAT PUMP/ELECTRIC HEAT



MODEL <sup>1, 6, 8, 9</sup>	PTH073G **AXXX	PTH093G **AXXX	PTH123G **AXXX	PTH153G **AXXX	PTH074G **AXXX	PTH094G **AXXX	PTH124G **AXXX	PTH154G **AXXX	
Voltage <sup>1, 3</sup>	230 / 208	230 / 208	230 / 208	230 / 208	265	265	265	265	
Capacity (BTU/h)	7,600	9,000	12,000	14,200	7,600	9,100	12,000	14,200	
Amps <sup>10</sup>	3.9	4.2	5.8	7.0	3.1	3.7	5.0	6.1	
Watts <sup>10</sup>	650	785	1,125 / 1,100	1,465 / 1,445	650	790	1,120	1,465	
EER	11.7	11.5	10.7	9.7	11.7	11.5	10.7	9.7	
<b>UNIT WITHOUT ELECTRIC HEATER</b>									
Min. Circuit Amps <sup>2, 4, 10</sup>	4.7	5.1	7.1	8.5	3.8	4.5	6.1	7.4	
CFM (Cool/Wet Coil)	High	340	330	340	390	340	330	340	390
	Low	245	245	245	340	245	245	245	340
CFM (Dry Coil)	High	370	360	370	410	370	360	370	410
	Low	270	270	270	370	270	270	270	370
Ventilated Air, CFM (Fan Only)*	65*	65*	65*	65*	65*	65*	65*	65*	
Ventilated Air, CFM (Comp & Fan)*	40*	40*	40*	40*	40*	40*	40*	40*	
Dehumidification (Pints/Hr.)	1.7	2.2	3.6	4.4	1.7	2.2	3.6	4.4	
Net Weight (lbs.)	108	112	115	126	108	112	115	125	
Ship Weight (lbs.)	123	127	132	143	123	127	132	142	

\* Actual vent CFM performance will vary due to application and installation conditions.

## NOTES

- <sup>1</sup> All 265-volt models must use an Amana® brand sub-base (PTSB4\*\*E) or an Amana® brand hard-wire kit (PTPWHWK4).
- <sup>2</sup> Minimum Circuit Ampacity (MCA) ratings conform to the National Electric Code; however, local codes should apply. Minimum voltage on 230/208-volt models is 197 volts; maximum is 253 volts.
- <sup>3</sup> Minimum voltage on 265-volt models is 239 volts; maximum is 292 volts.
- <sup>4</sup> Overcurrent protection for all units without electric heaters is 15 amps. Overcurrent protection on 265-volt models must be cartridge-style time-delay fuses (included and factory-installed on all Amana® brand 265-volt chassis).
- <sup>5</sup> Heating capacity and efficiency based on unit operation without condensate pump; unit automatically switches to electric heat at approximately 24°F outdoor ambient.
- <sup>6</sup> Specify two-digit heater kW size to complete model number.
- <sup>7</sup> R-410A refrigerant used in all systems.
- <sup>8</sup> All units meet or exceed ASHRAE 90.1 standards.
- <sup>9</sup> All units less than 250 volts have a Leak Current Detector Interrupter (LCDI) power cord and meet UL 484 standards.
- <sup>10</sup> Refer to electric heat performance data for total MCA and recommended overcurrent protection. Amps and Watts notation refers to compressor only.





# PRODUCT SPECIFICATIONS: PTC / PTH MODELS — ELECTRIC HEAT PERFORMANCE

(Primary Heating for PTC Models; Auxiliary Heating for PTH Models; See below for Power Cord Configuration)

VOLTAGE	ELECTRIC HEATER SIZE (kW)	NO. OF STAGES	NOMINAL HEATING (BTU/H)			TOTAL WATTS <sup>6</sup>	TOTAL AMPS	MIN. CIRCUIT AMPACITY <sup>2</sup>	MOD <sup>4</sup> (AMPS)	POWER CORD
			@ 230V	@ 208V	@ 265V					
230/208V	2.5	1	8,500	6,800	--	2,570 / 2,115	11.2 / 10.1	14.1	15	6-15 P
230/208V	3.5	1	12,000	9,900	--	3,570 / 2,935	15.5 / 14.1	19.5	20	6-20 P
230/208V	5	1	17,100	14,000	--	5,070 / 4,160	22.1 / 20.0	27.6	30	6-30 P
265V	2.5	1	--	--	8,500	2,570	9.7	12.2	15	7-20 P
265V	3.7	1	--	--	12,600	3,770	14.2	17.9	20	7-20 P
265V	5	1	--	--	17,100	5,070	19.2	23.9	25	7-30 P

## NOTES

- <sup>1</sup> All 265-volt models must use an Amana® brand sub-base (PTSB4\*\*E) or an Amana® brand hard-wire kit (PTPWHWK4).
- <sup>2</sup> Minimum branch circuit ampacity ratings conform to the National Electric Code; however, local codes should apply.
- <sup>3</sup> Minimum voltage on 230/208-volt models is 197 volts; maximum is 253 volts. Minimum voltage on 265-volt models is 239 volts; maximum is 292 volts.
- <sup>4</sup> Overcurrent protection for all units without electric heaters is 15 amps. Overcurrent protection on 265-volt models must be cartridge-style time-delay fuses (included and factory-installed on all Amana® brand 265-volt chassis).
- <sup>5</sup> Heating capacity and efficiency based on unit operation without condensate pump; unit automatically switches to electric heat at approximately 24°F outdoor ambient.
- <sup>6</sup> Total watts for 15,000 BTU/h models; subtract 20 watts for PT07/09/12
- <sup>7</sup> Specify two-digit heater kW size to complete model number.
- <sup>8</sup> R-410A refrigerant used in all systems.
- <sup>9</sup> All units meet or exceed ASHRAE 90.1 standards.
- <sup>10</sup> All units less than 250 volts have a Leak Current Detector Interrupter (LCDI) power cord and meet UL 484 standards.

# PRODUCT SPECIFICATIONS: PTH MODELS — REVERSE-CYCLE HEATING PERFORMANCE



HEATING CAPACITY <sup>1</sup>	PTH073G **AXXX	PTH093G **AXXX	PTH123G **AXXX	PTH153G **AXXX	PTH074G **AXXX	PTH094G **AXXX	PTH124G **AXXX	PTH154G **AXXX
Voltage <sup>1, 3</sup>	230 / 208	230 / 208	230 / 208	230 / 208	265	265	265	265
BTU/h <sup>5</sup>	6,800	8,300 / 8,100	11,500 / 11,300	13,800 / 13,600	6,800	8,300	11,400	13,700
Amps <sup>10</sup>	3.9	4.2	5.8	7.0	3.1	3.7	5.0	6.1
Watts <sup>10</sup>	585 / 570	715 / 700	1085 / 1035	1350 / 1330	570	715	1080	1340
COP <sup>5</sup>	3.4 / 3.5	3.4	3.1 / 3.2	3.0	3.5	3.4	3.1	3.0
CFM (Dry)	370	360	370	410	370	360	370	410

COP = Coefficient of Performance; per AHRI Test Procedures, units are rated for capacities and efficiencies.

## NOTES

- <sup>1</sup> All 265-volt models must use an Amana® brand sub-base (PTSB4\*\*E) or an Amana® brand hard-wire kit (PTPWHWK4).
- <sup>2</sup> Minimum branch circuit ampacity ratings conform to the National Electric Code; however, local codes should apply.
- <sup>3</sup> Minimum voltage on 230/208-volt models is 197 volts; maximum is 253 volts. Minimum voltage on 265-volt models is 239 volts; maximum is 292 volts.
- <sup>4</sup> Overcurrent protection for all units without electric heaters is 15 amps. Overcurrent protection on 265-volt models must be cartridge-style time-delay fuses (included and factory-installed on all Amana® brand 265-volt chassis).
- <sup>5</sup> Heating capacity and efficiency based on unit operation without condensate pump; unit automatically switches to electric heat at approximately 24°F outdoor ambient.
- <sup>6</sup> Specify two-digit heater kW size to complete model number.
- <sup>7</sup> R-410A refrigerant used in all systems.
- <sup>8</sup> All units meet or exceed ASHRAE 90.1 standards.
- <sup>9</sup> All units less than 250 volts have a Leak Current Detector Interrupter (LCDI) power cord and meet UL 484 standards.
- <sup>10</sup> Refer to electric heat performance data for total MCA and recommended overcurrent protection. Amps and Watts notation refers to compressor only.

# ACCESSORIES

## WALL SLEEVES

All our wall sleeves have industry standard dimensions of 42" wide x 16<sup>1</sup>/<sub>8</sub>" high. All Stonewood Beige G-90 metal wall sleeves are thermally insulated and include a weather board for use during construction. The WS900D, SC and INTERNAL 14<sup>1</sup>/<sub>8</sub>" depth is the industry standard. Sleeves may be shipped separately to allow for installation during construction.

## STANDARD DEPTH SLEEVES

WS900E	Standard PTAC sleeve
WS900SC	Seacoast triple protected
WS900D-INTERNAL	Internal drain only for window-wall installations (DK900D sold separately)

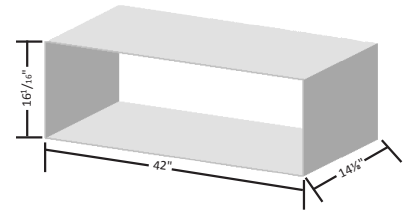

## EXTRA DEEP SLEEVES

We offer sleeves in several depths for thicker wall installations or special room configurations

WS9xxD1	16" to 24" in 1" increments
WS928D1	Extra deep 28"
WS930D1	Extra deep 30"
WS936D1	Extra deep 36"

## OUTDOOR GRILLES

Available in stamped-aluminum or architecturally louvered for application with an Amana brand WS900D wall sleeve.

AGK—Extruded aluminum architectural grille available with anodized aluminum finish or a baked-on paint finish for durability. Choose from 3 stock colors or a custom color to blend with your building's exterior color scheme. Colors include:

CB (Clear Anodized), DB (Dark Brown/Bronze), TB (Stonewood Beige), WB (White), SB (Special/Custom Colors)

PGK—One-piece injection molded grille using a polymer blend of engineered thermoplastic high-impact strength material with chemical resistance and an exterior UV protective coating.

Choose from 3 stock colors:

DB (Dark Brown/Bronze), TB (Stonewood Beige), WB (White)

## STANDARD OUTDOOR GRILLE

SGK01B	Single Pack
SGK01TB	Stonewood Beige

## ARCHITECTURAL OUTDOOR GRILLE

AGK01CB	Anodized Aluminum (Silver)
AGK01DB	Dark Bronze/Brown
AGK01TB	Stonewood Beige
AGK01WB	Amana White
AGK01SB	Custom Colors
PGK01DB	Dark Bronze/Brown
PGK01TB	Stonewood Beige
PGK01TB	Amana White

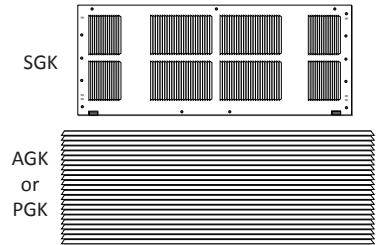

## CONDENSATE DRAIN KIT

Attaches to the wall sleeve base pan for controlled internal or external disposal of condensate.

DK900D	Condensate Drain Kit (use with WS900E)
DK9001D	Condensate Drain Kit (use with WS900B)

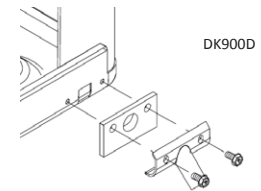

## LOW-VOLTAGE WIRE HARNESS KIT

For quick connections of the remote, or wired, thermostats, wired EMS, or front desk with jumpers and connectors.

PWHK01C	Wire Harness Kit
---------	------------------

## REMOTE ESCUTCHEON KIT (NOT SHOWN)

Optional kit for use with units controlled via a wired, remote thermostat. Covers control touch-pad for wired thermostat installations.

REK10B	Remote Escutcheon Kit (10-pack)
--------	---------------------------------

Each kit contains 80 wires and wire nuts, enough to attach a thermostat and one additional accessory to 10 PTAC units. Wires come in assorted colors for easy attachment.

## SUB-BASE KIT

The fully skirted sub-base conceals wiring while providing strong support, if needed. Plug-in receptacle and field-wiring access speeds installation. Electrical accessories, such as fuse holders, circuit breakers and disconnect switches, meet N.E.C. requirements.

PTSB320E	230/208V 15/20A
PTSB330E	230/208V 30A
PTSB420E	265V 15/20A
PTSB430E	265V 25A
PTSB000E	Non-electrical

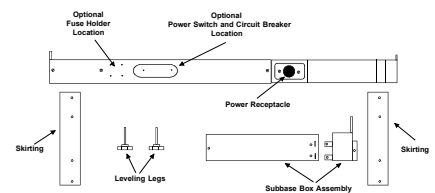

## LEVELING LEGS

Gives wall sleeve front support and helps to level the unit for installation.

LL2B	Leveling legs for WS9** sleeves
------	---------------------------------

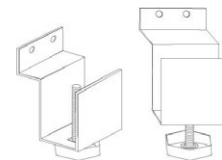

## HARD-WIRE KITS

Used to permanently wire to the chassis when a standard sub-base and power cord are not used.

PTPWHWK4	Armored Cable - all voltages
PTQC03A	Quick Connect - 230/208 V
PTQC04A	Quick Connect - 265 & 115 V



# ACCESSORIES (CONT.)

## POWER DISCONNECT SWITCH

The PSHW\*\*A power disconnect switch can be used for 265-volt or 230/208-volt physical disconnect, where required by local codes. The switch is rated at 30-amp capacity. The switch is for use with and Amana® brand standard sub-bases or PTPWHWK4 Hard Wire Kit.

PSHW03A	230/208V
PSHW04A	265V

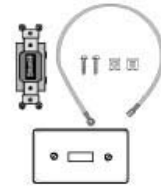

## FUSE HOLDER KIT

Cartridge-style fuses can be installed in the fuse holder for use in the sub-base or chassis. Available in 15, 20 and 30 amp (included on 265-volt unit).

FHK315C	230/208V 15A
FHK315E	230/208V 15A (R-410A)
FHK320C	230/208V 20A
FHK320E	230/208V 20A (R-410A)
FHK330C	230/208V 30A
FHK330E	230/208V 30A (R-410A)

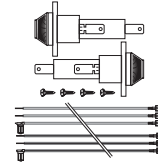

## CIRCUIT BREAKER KIT (230/208V ONLY)

The circuit breaker kit, available in 15, 20 or 30 amp, can be used with Amana brand sub-bases. It gives overcurrent protection, and its location allows you to turn the unit on or off without tools.

CBK3**C	Circuit Breaker Kit
---------	---------------------

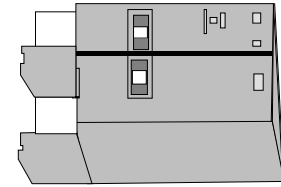

## DUCT EXTENSION KIT

Extends air distribution to an adjoining room. Consists of a main duct for the room of origin and an extension duct to reach the adjoining room and terminal duct. PTDK01A allows for the new "B" series unit to work with the "A" series duct kits.

### Main Duct Kit



### Extension Duct Kit



### Terminal Duct Kit

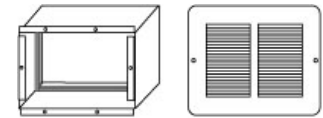

MDK02B	Main Duct – R-22
MDK01E	Main Duct – R-410A
EDK02B	Extension Duct

TDK02B	Terminal Duct
PTDK01A	Transition Duct Only – R-22
PTDK01E	Transition Duct Only – R-410A

## POWER VENT KIT

Installation of Power Vent increases CFM up to approximately 95. Vent door will automatically close when unit fan is off.

R-410A models must have these kits installed at the factory.

PVK3A	230/208V – R-22
PVK4A	265V – R-22

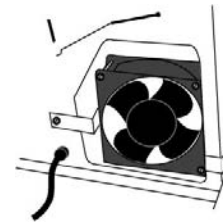

## CONDENSER BAFFLE KIT

For use on non-baffled grilles. These deflectors direct the air in toward the center and away from the inlet to prevent recirculation of the hot condenser air.

DGK1B	Condenser Baffle Kit
-------	----------------------

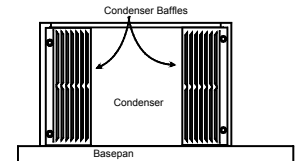

## SUB-BASE EXTENSION COVER KIT

Converts older 30-amp sub-bases to allow for installation of the larger 30-amp LCDI power cord and plugs.

SBEC10A	10 Pack
---------	---------

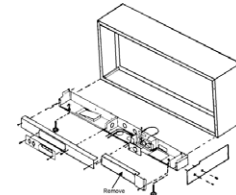

## CONDENSATE REMOVAL PUMP

Can be field-installed. Assists in removing condensate developed by heat pump operation and transfers it to indoor coil to dissipate into room while adding humidity to the room.

CDP302	230/208V – R-22
CDP402	265V – R-22
CDP302E	230/208V – R-410A



# ACCESSORIES (CONT.)

## SECURITY KEY LOCKS

In conjunction with the tamper-resistant front, the installation of Amana® brand security key locks prevents tampering of the controls used to set temperature, heating and cooling functions. UL approved for institutional use only.

KL03B	Security Key Lock (R-22)
KL03E	Security Key Lock (R-410A)

## POWER DOOR KIT

Vent door will automatically open when unit fan is on.

PDK3A	230/208V – R-22
PDK4A	265V – R-22
PDK3E	230/208V – R-410A
PDK4E	265V – R-410A

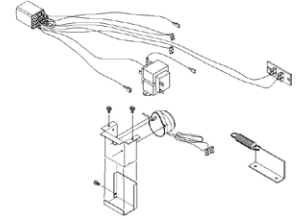

## THERMOSTATS

The following thermostats offer remote control. Any thermostat other than those listed must be submitted to Goodman Company, L.P., for approval prior to use.

MODEL #	HEAT STAGES	COOL STAGES	FAN SPEED	# OF WIRES REQUIRED	TEMP LIMITING	BACKLIT	DISPLAY	TYPE	SHAPE & ORIENTATION	CONNECTION
2246002	1	1	1	5	No	Yes	Digital	Manual	Rect./Horiz.	Wired
2246003	2	2	2	7	Yes	Yes	Digital	Manual	Rect./Horiz.	Wired
2246007	2	2	2	7	Yes	Yes	Digital	Auto-Change	Rect./Horiz.	Wired
2246008	2	2	2	7	Yes	Yes	Digital	Programmable	Rect./Horiz.	Wired
DS01E	2	2	2	0	Yes	Yes	Digital	Manual	Rect./Horiz.	Wireless

## HYDRONIC HEAT KIT

Add-on kits fit all units allowing the addition of hydronic water or hydronic steam heat to cooling and heating units. The kits feature left- or right-hand piping. Unit retains complete service access with a kit installed. Unit must be connected to and operated by a wall thermostat.

HWK03B	Hydronic Water Kit – R-22
HVK03B	Hydronic Steam Kit – R-22
HWK03E	Hydronic Water Kit – R-410A
HVK03E	Hydronic Steam Kit – R-410A

Hydronic Heat Kit-Side View

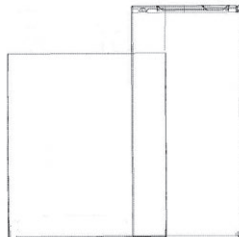

Hydronic Heat Kit-Top View



Hydronic Heat Kit-Right View

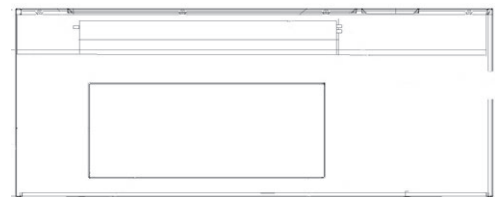

## HYDRONIC VALVES

Water and steam valves are available for use with the HWK03 (water) and HVK03 (steam) heat kits.

VS2WNCA*	2-way/24V/NC/Steam
VS2WNOA*	2-way/24V/NO/Steam
VW2WNCA*	2-way/24V/NC/End Switch
VW2WNOA*	2-way/24V/NO/End Switch
VW3WNC2B*	3-way/24V/NC/NO/End Switch

\* Pop-top Actuator

## WIRELESS RF (RADIO FREQUENCY) CONTROLS

All DigiSmart PTACs come factory-ready to be controlled via wireless RF devices. 2.4 Ghz 802.15.4 protocol assures robust communications and response.

DS01E	Thermostat: 2-way communications
DD01E	Occupancy Sensor: EMS activation
DT01A	Antennae / Router
GT01A	Generic Radio Antenna / Router
DD01F	Door Switch: EMS Activation
DP01E	Web-enabled Platform Server
DL01E	Web-enabled Platform Server Link



## REMOTE TEMPERATURE SENSOR

Unit can be wired to sense room temperature away from the PTAC to have accurate readings.

RTS03	Remote wall-mounted sensor
-------	----------------------------

# ACCESSORIES (CONT.)

## WIRED ENERGY MANAGEMENT CONTROL

Includes PIR occupancy sensor power from the DigiSmart control and door switch; cannot be used with a remote wired thermostat.

WEMR01W	Recess-mounted door switch
WEMS01B	Surface-mounted door switch (Brown)
WEMS01W	Surface-mounted door switch (White)

## WALL SLEEVE EXTENSION ADAPTER KITS

Room-side extension kits to increase the depth of the existing sleeve to allow for an industry-standard PTAC to be installed.

SECM1001A	Climate Master 12½" Sleeve Extension (10 Pack)
SEZA0501A	Zone Aire 11½" Sleeve Extension (5 Pack)

## CURTAIN BAFFLE KIT

The color-matched polymer curtain baffles help to prevent curtains from falling into the discharge air stream and causing recirculation, reducing efficiencies and shortening compressor life.

PTCB10B	10 Pack for R-22 units
PTCB10E	10 Pack for R-410A units

# MONTHLY MAINTENANCE

## INTAKE AIR FILTERS

It is extremely important to clean the inlet air filters once a month (or more often if operated in dusty or dirty locations or conditions) to properly maintain the operational performance of the PTAC unit. The two intake air filters (constructed of durable polypropylene) can be easily inserted into the cabinet front using the cabinet filter guides. Before cleaning the intake filters, turn the unit off by setting the mode switch to the OFF position. Filters should be cleaned as required. The following procedure is used to remove the intake filters:

1. Facing the unit, pull up on the filter handles located at the front top of the unit.
2. Pull each filter upward and remove.
3. Clean filters with vacuum or with running water. Reverse this procedure to reinstall the filters.

**Note:** Accessory filter kits are available from your sales person. All filters are permanent and cleanable. Consult your I&O Manual for other monthly cleaning instructions.

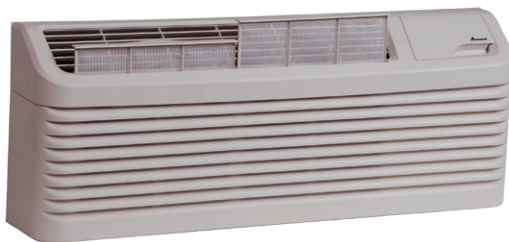

## SPARE FILTERS

Helps keep dirt and lint out of the air and off the coil, thus increasing the unit's efficiency. Amana® brand filters are easy to remove, wash and replace.

FK10A	10-PACK - A SERIES
FK10B	10-PACK - B, C & D SERIES
FK10E	10-PACK - E SERIES (THIS MODEL REQUIRES 2 FILTERS PER CHANGE.)

## REPLACEMENT CHARCOAL FILTER KIT

Absorbs airborne odors caused by cigarette, pipe or cigar smoke and odors caused by mold, mildew, etc. Filters are made of polyester fibers coated with activated charcoal and are individually wrapped. These filters are permanent and can be washed or cleaned. Call your Amana® brand PTAC sales person for details. 10 filters per pack.

CFK10A	10-PACK - A SERIES (R-22)
CFK10B	10-PACK - B, C & D SERIES (R-22)

# UNIT WITH ACCESSORY WALL SLEEVE AND SUB-BASE ACCESSORY

TOP VIEW

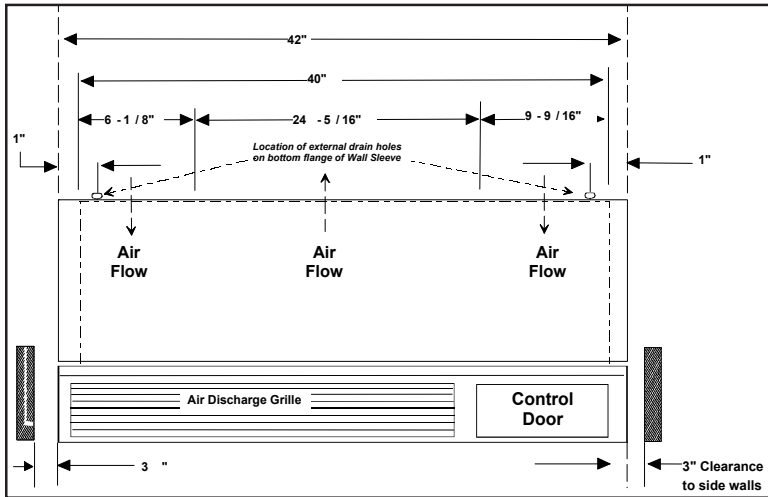

FRONT VIEW

58" LCDI CORD SET — 230V/208V UNIT\*

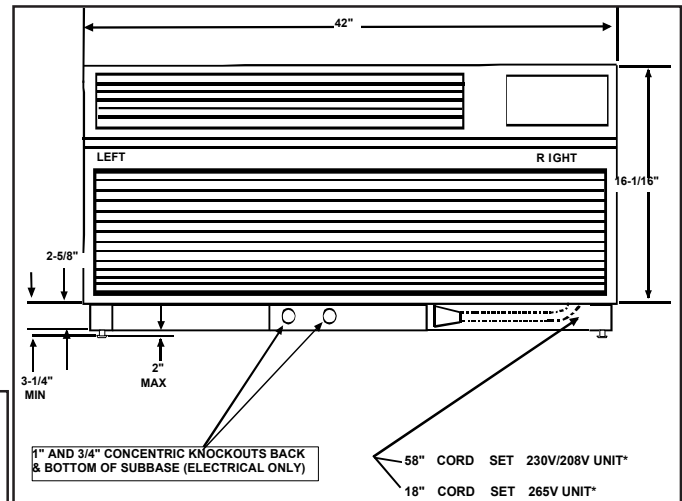

RIGHT VIEW

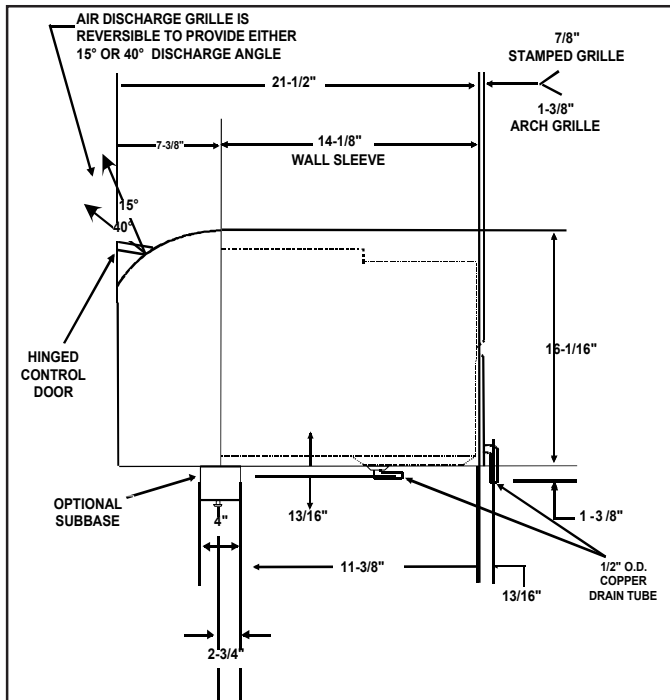

# FRAMING FOR ACCESSORY WALL SLEEVE (WS9XX)

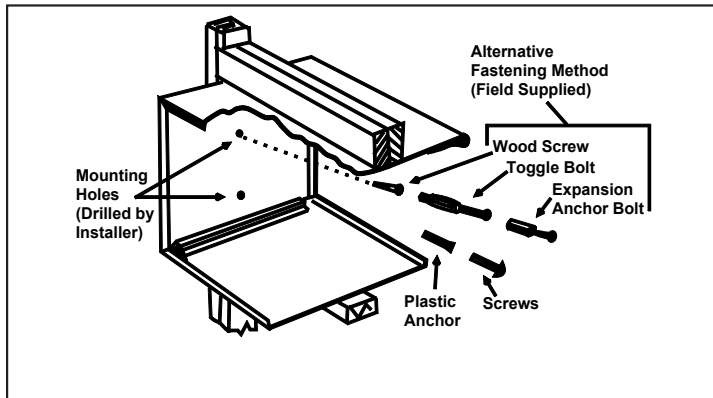

Wall Sleeve must extend a minimum of  $\frac{3}{4}$ " beyond outside wall to allow for proper caulking.

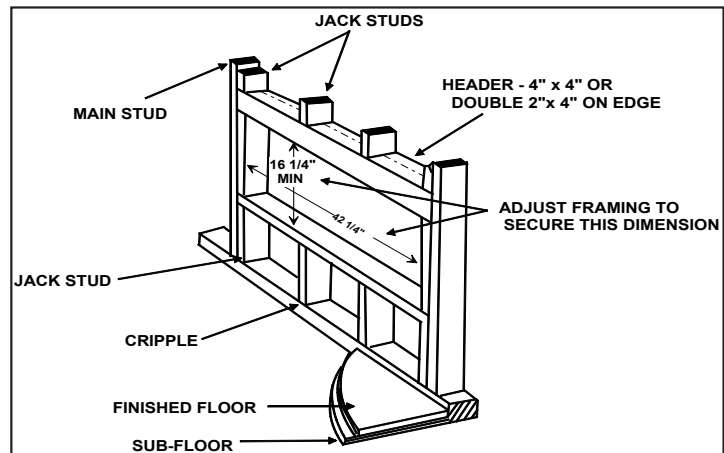

Wall sleeve opening height should be squared with wall sleeve opening width.	H = 16 $\frac{1}{4}$ "
	W = 42 $\frac{1}{4}$ "

## FASTENING WALL SLEEVE

When installed in an opening, the Wall Sleeve must be horizontally level (side-to-side) and pitched  $\frac{1}{4}$  bubble to the outside.

(NOTE: To ensure unit's maximum efficiency, **DO NOT** over- or under-pitch.)

## INSTALLATION NOTES

1. If **Sub-base** (PTSB\*\*\*E) is installed, allow minimum  $3\frac{3}{4}$ " height clearance and maximum 5" height clearance between wall sleeve and floor; allow minimum  $2\frac{3}{4}$ " protrusion from a finished wall. See Note 4 if using hydronic units.
2. **Drain Kit** (DK900D) shipped separately. Can be mounted either right side, left side or bottom of sleeve. If mounted to bottom of sleeve, allow 2" height clearance from floor to bottom of sleeve.
3. For UL approval, 265V units must use Amana® brand **Sub-base** (PTSB\*\*\*E) or Amana® brand **Hard Wire Kit** (PSHW04A). Overcurrent protection on 265V units must be by cartridge-style time delay fuses, **which are included and factory-installed on the Amana® brand 265V chassis.**
4. If **Hydronic Kit** (HWK03 or HVK03) is installed, **Wall Sleeve** must extend exactly 3" into the room from the finished interior wall. If using the Amana® brand **Sub-base** (PTSB\*\*\*E), only the minimum  $3\frac{3}{4}$ " height clearance between wall sleeve and floor is permissible. Unit must also be operated with a remote-mounted thermostat.
5. If **Duct Kit** (MDK\*\*\*\*) is installed, allow a minimum of  $2\frac{3}{4}$ " into the room from the finished interior wall.

# PACKAGED TERMINAL AIR CONDITIONERS AND HEAT PUMPS

WITH **DigiSmart** CONTROL BOARD



## 7-Button Control Pad

- One-Touch Activation
- Total Fan Control
- Easy-to-Read Display

